

CRYSTAL-RS

~5.1° spot beam. Assembly with holder.

SPECIFICATION:

Dimensions	Ø 49.7 mm
Height	28.7 mm
Fastening	pin, screw
ROHS compliant	yes ⓘ

MATERIALS:

Component	Type	Material	Colour	Finish
F12916_CRYSTAL-RS	Single lens	PMMA	clear	
C13478_CRYSTAL-HLD	Holder	PC	white	

ORDERING INFORMATION:

Quantities for one set:

Single lens	1
Holder	1



Component		Qty in box	MOQ	MPQ	Box weight (kg)
F12916_CRYSTAL-RS	Single lens	288	64	32	8.6
» Box size: 480 x 280 x 300 mm					
C13478_CRYSTAL-HLD	Holder	1152	64	32	6.1
» Box size: 480 x 280 x 300 mm					

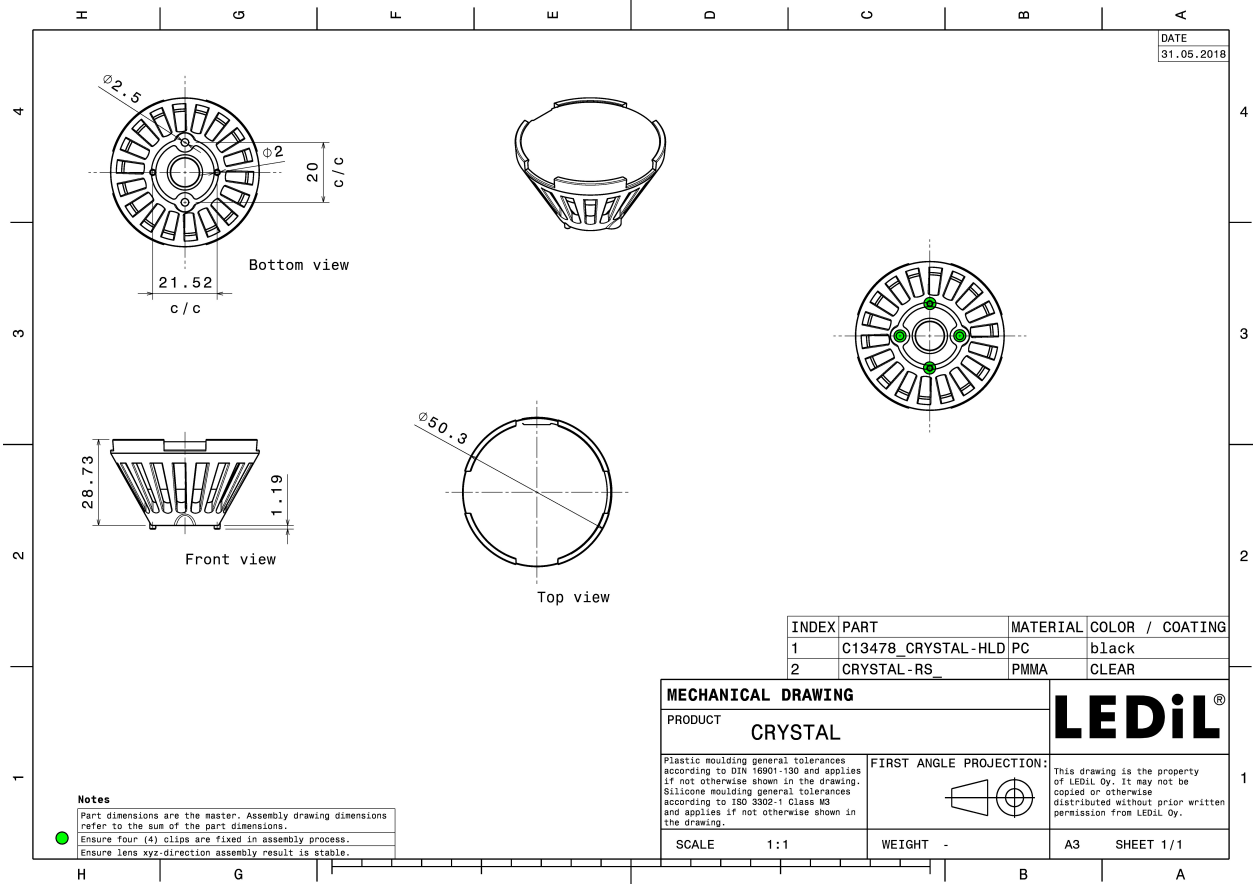

See also our general installation guide: www.ledil.com/installation_guide

OPTICAL RESULTS (MEASURED):

CREE → LED

LED XHP35 HI
 FWHM / FWTM 5.7° / 15.0°
 Efficiency 89 %
 Peak intensity 48.3 cd/lm
 LEDs/each optic 1
 Light colour White
 Required components:

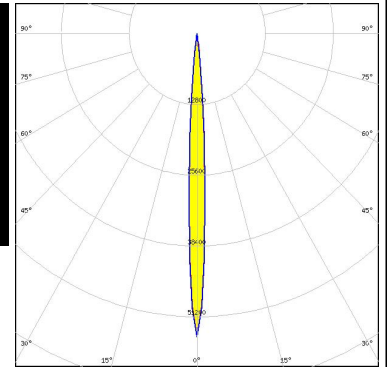
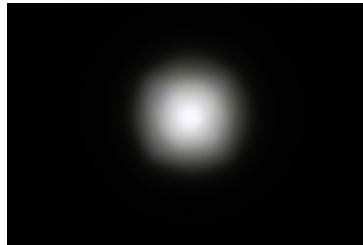

CREE → LED

LED XHP50
 FWHM / FWTM 11.0° / 24.0°
 Efficiency 93 %
 Peak intensity 14.1 cd/lm
 LEDs/each optic 1
 Light colour White
 Required components:

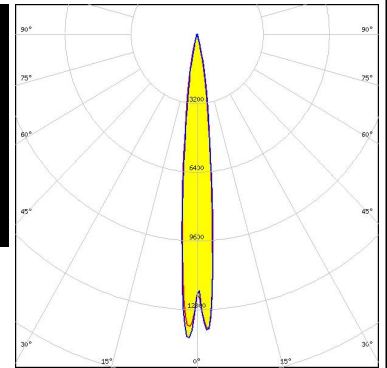

CREE → LED

LED XM-L
 FWHM / FWTM 7.0° / 17.0°
 Efficiency 94 %
 Peak intensity 34.9 cd/lm
 LEDs/each optic 1
 Light colour White
 Required components:

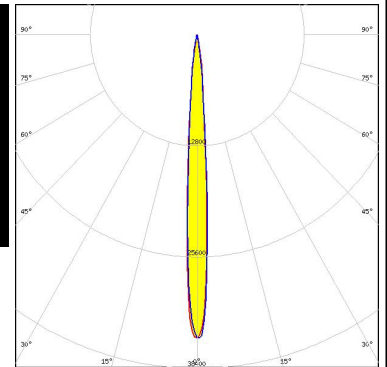
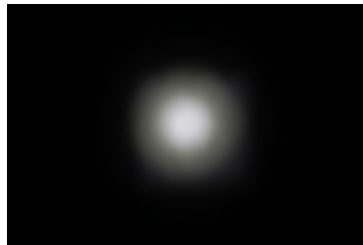





CREE → LED



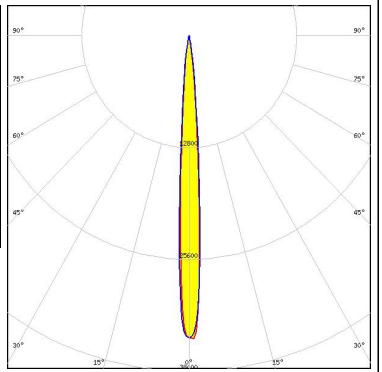
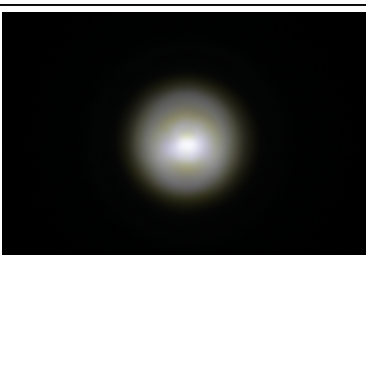
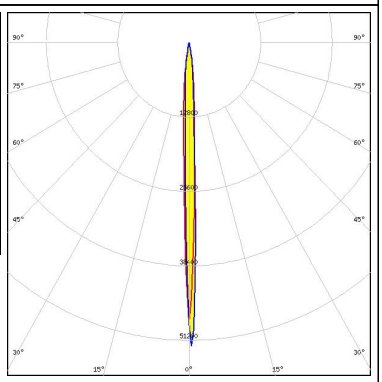

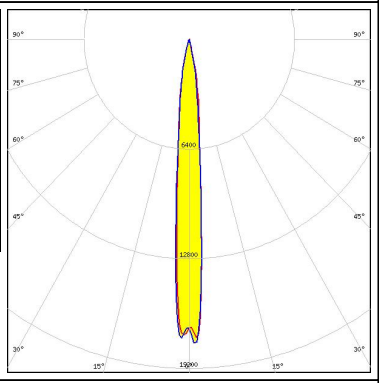
LED XP-G
 FWHM / FWTM 4.9° / 11.4°
 Efficiency 89 %
 Peak intensity 68.3 cd/lm
 LEDs/each optic 1
 Light colour White
 Required components:





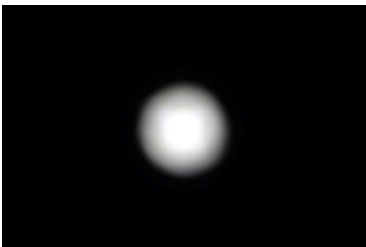
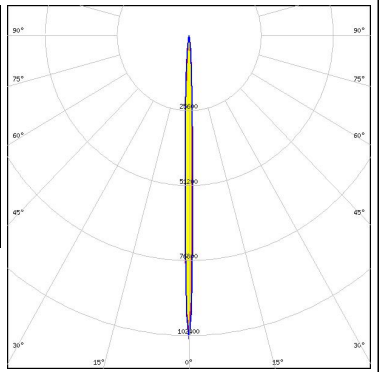

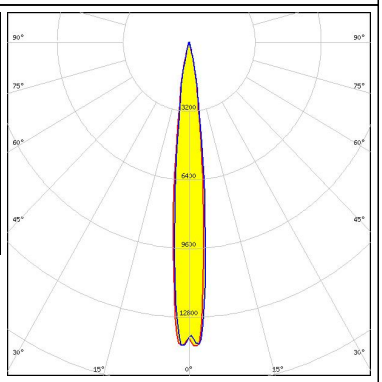
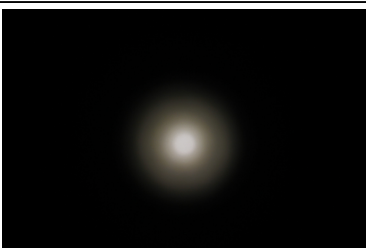
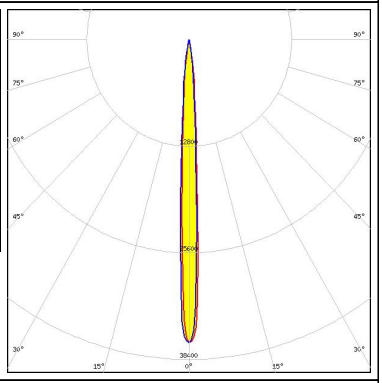

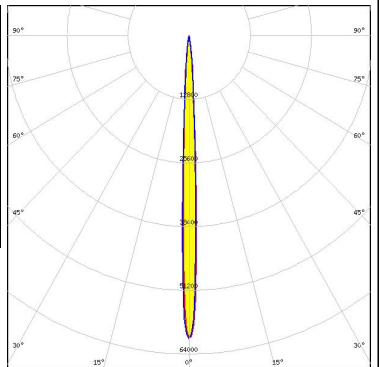
OPTICAL RESULTS (MEASURED):

<p>CREE LED</p> <p>LED: XP-L HD FWHM / FWTM: 7.0° / 15.0° Efficiency: 88 % Peak intensity: 34.7 cd/lm LEDs/each optic: 1 Light colour: White Required components:</p>		
<p>LUMILEDS</p> <p>LED: LUXEON 3030 2D (Round LES) FWHM / FWTM: 4.0° / 15.0° Efficiency: 94 % Peak intensity: 52.1 cd/lm LEDs/each optic: 1 Light colour: White Required components:</p>		
<p>LUMILEDS</p> <p>LED: LUXEON 5050 Round LES FWHM / FWTM: 9.0° / 24.0° Efficiency: 94 % Peak intensity: 17.8 cd/lm LEDs/each optic: 1 Light colour: White Required components:</p>		
<p>LUMILEDS</p> <p>LED: LUXEON A FWHM / FWTM: 5.1° / 14.0° Efficiency: 89 % Peak intensity: 58.9 cd/lm LEDs/each optic: 1 Light colour: White Required components:</p>		

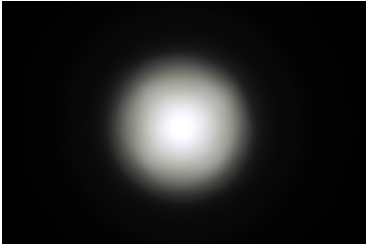
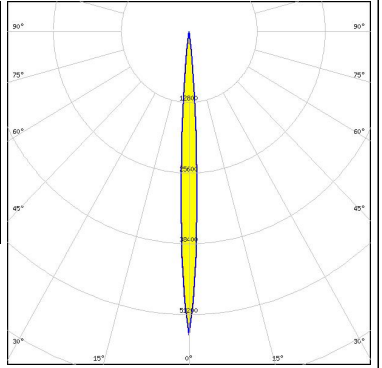

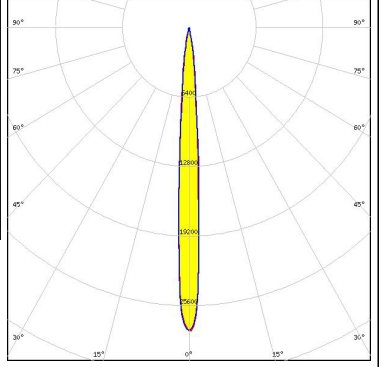

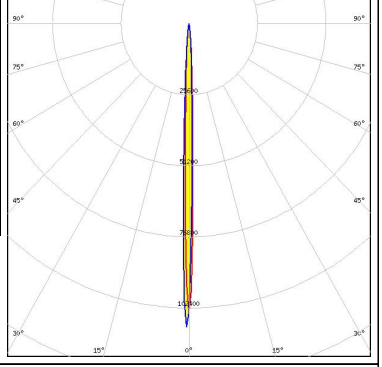
OPTICAL RESULTS (MEASURED):

<p>LUMILEDS</p> <p>LED LUXEON Z ES</p> <p>FWHM / FWTM 3.0° / 9.0°</p> <p>Efficiency 93 %</p> <p>Peak intensity 103.8 cd/lm</p> <p>LEDs/each optic 1</p> <p>Light colour White</p> <p>Required components:</p>		
<p>NICHIA</p> <p>LED NV4x144A</p> <p>FWHM / FWTM 12.0° / 25.0°</p> <p>Efficiency 92 %</p> <p>Peak intensity 14.2 cd/lm</p> <p>LEDs/each optic 1</p> <p>Light colour White</p> <p>Required components:</p>		
<p>NICHIA</p> <p>LED NVSW3x9A</p> <p>FWHM / FWTM 6.0° / 16.0°</p> <p>Efficiency 89 %</p> <p>Peak intensity 36.5 cd/lm</p> <p>LEDs/each optic 1</p> <p>Light colour White</p> <p>Required components:</p>		
<p>NICHIA</p> <p>LED NVSW719AC</p> <p>FWHM / FWTM 5.0° / 12.0°</p> <p>Efficiency 93 %</p> <p>Peak intensity 61 cd/lm</p> <p>LEDs/each optic 1</p> <p>Light colour White</p> <p>Required components:</p>		





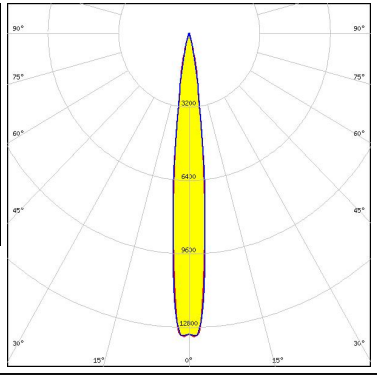

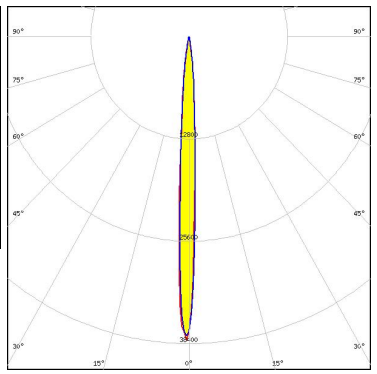

OPTICAL RESULTS (MEASURED):

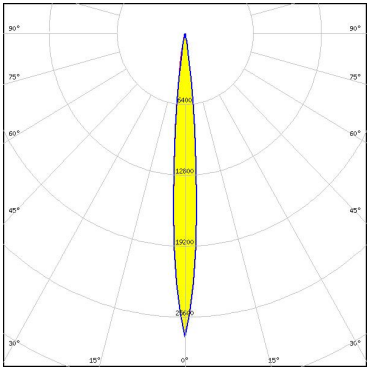
<p>NICHIA</p> <p>LED NVSxx19B/NVSxx19C FWHM / FWTM 5.3° / 17.0° Efficiency 89 % Peak intensity 42.5 cd/lm LEDs/each optic 1 Light colour White Required components:</p>		
<p>NICHIA</p> <p>LED NWSx229A FWHM / FWTM 8.0° / 18.0° Efficiency 92 % Peak intensity 27.9 cd/lm LEDs/each optic 1 Light colour White Required components:</p>		
<p>OSRAM <small>Opto Semiconductors</small></p> <p>LED OSLON SSL 150 FWHM / FWTM 3.0° / 9.0° Efficiency 94 % Peak intensity 108.9 cd/lm LEDs/each optic 1 Light colour White Required components:</p>		
<p>SAMSUNG</p> <p>LED LH351Z FWHM / FWTM 4.4° / 12.0° Efficiency 90 % Peak intensity 77 cd/lm LEDs/each optic 1 Light colour White Required components:</p>		

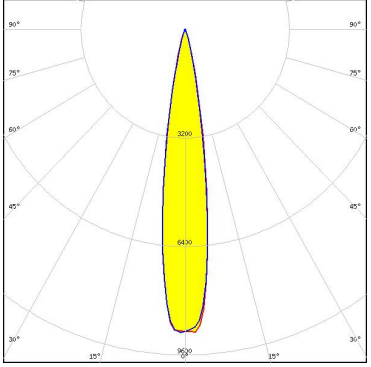
OPTICAL RESULTS (MEASURED):

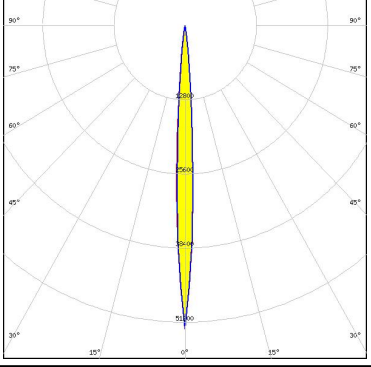
<p> SEOUL SEMICONDUCTOR</p> <p>LED WICOP 5050</p> <p>FWHM / FWTM 12.0° / 25.0°</p> <p>Efficiency 92 %</p> <p>Peak intensity 13.3 cd/lm</p> <p>LEDs/each optic 1</p> <p>Light colour White</p> <p>Required components:</p>		
<p> SEOUL SEMICONDUCTOR</p> <p>LED Z5M3</p> <p>FWHM / FWTM 6.0° / 16.0°</p> <p>Efficiency 94 %</p> <p>Peak intensity 3.8 cd/lm</p> <p>LEDs/each optic 1</p> <p>Light colour White</p> <p>Required components:</p>		

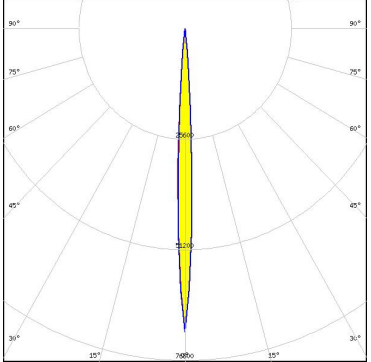
OPTICAL RESULTS (SIMULATED):

	<p>LED XHP50.3 HI FWHM / FWTM 10.0 + 8.0° / 18.0° Efficiency 97 % Peak intensity 27.4 cd/lm LEDs/each optic 1 Light colour White Required components:</p>	
	<p>LED XHP70.2 FWHM / FWTM 16.0° / 30.0° Efficiency 95 % Peak intensity 9 cd/lm LEDs/each optic 1 Light colour White Required components:</p>	
	<p>LED XP-G3 FWHM / FWTM 6.0° / 14.0° Efficiency 95 % Peak intensity 52.3 cd/lm LEDs/each optic 1 Light colour White Required components:</p>	
	<p>LED XP-L HI FWHM / FWTM 5.6° / 12.0° Efficiency 94 % Peak intensity 70.2 cd/lm LEDs/each optic 1 Light colour White Required components:</p>	 

OPTICAL RESULTS (SIMULATED):

CREE LED

LED XP-P
 FWHM / FWTM 4.0° / 10.0°
 Efficiency 95 %
 Peak intensity 115.4 cd/lm
 LEDs/each optic 1
 Light colour White
 Required components:

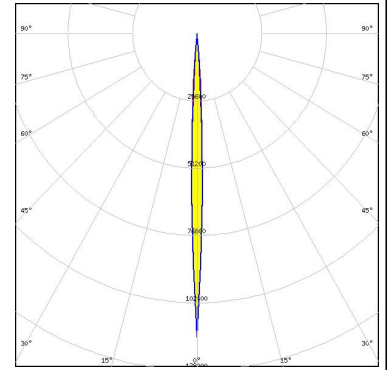

CREE LED

LED XQ-E HI
 FWHM / FWTM 4.5° / 10.0°
 Efficiency 95 %
 Peak intensity 106.7 cd/lm
 LEDs/each optic 1
 Light colour White
 Required components:

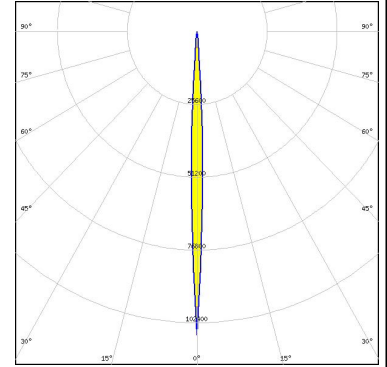

LUMILEDS

LED LUXEON C
 FWHM / FWTM 4.0° / 10.0°
 Efficiency 91 %
 Peak intensity 109.6 cd/lm
 LEDs/each optic 1
 Light colour White
 Required components:

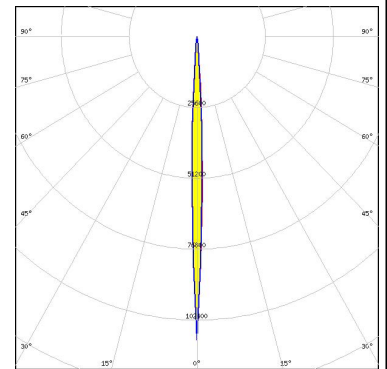

LUMILEDS

LED LUXEON CZ
 FWHM / FWTM 4.0° / 8.0°
 Efficiency 93 %
 Peak intensity 181 cd/lm
 LEDs/each optic 1
 Light colour White
 Required components:

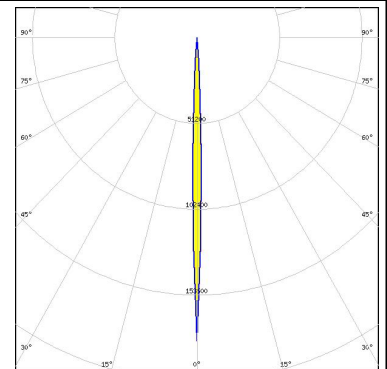

OPTICAL RESULTS (SIMULATED):

<p>LUMILEDS</p> <p>LED LUXEON HL2X</p> <p>FWHM / FWTM 6.0° / 14.0°</p> <p>Efficiency 95 %</p> <p>Peak intensity 52.6 cd/lm</p> <p>LEDs/each optic 1</p> <p>Light colour White</p> <p>Required components:</p>	
<p>LUMILEDS</p> <p>LED LUXEON Rebel Plus</p> <p>FWHM / FWTM 6.0° / 10.0°</p> <p>Efficiency 95 %</p> <p>Peak intensity 84.3 cd/lm</p> <p>LEDs/each optic 1</p> <p>Light colour White</p> <p>Required components:</p>	
<p>LUMILEDS</p> <p>LED LUXEON Rubix</p> <p>FWHM / FWTM 4.0° / 10.0°</p> <p>Efficiency 95 %</p> <p>Peak intensity 114.3 cd/lm</p> <p>LEDs/each optic 1</p> <p>Light colour Green</p> <p>Required components:</p>	
<p>LUMILEDS</p> <p>LED LUXEON Rubix</p> <p>FWHM / FWTM 4.0° / 10.0°</p> <p>Efficiency 95 %</p> <p>Peak intensity 106.8 cd/lm</p> <p>LEDs/each optic 1</p> <p>Light colour White</p> <p>Required components:</p>	

OPTICAL RESULTS (SIMULATED):

LUMILEDS

LED LUXEON Rubix
 FWHM / FWTM 4.0° / 10.0°
 Efficiency 95 %
 Peak intensity 119.4 cd/lm
 LEDs/each optic 1
 Light colour Red
 Required components:

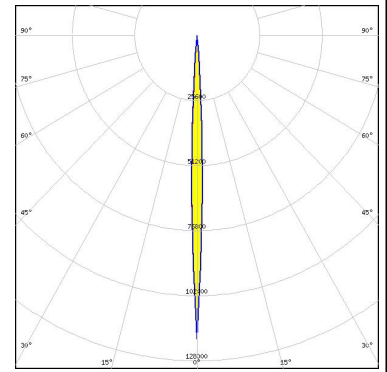

LUMILEDS

LED LUXEON Rubix
 FWHM / FWTM 10.0° / 17.0°
 Efficiency 97 %
 Peak intensity 26.8 cd/lm
 LEDs/each optic 4
 Light colour RGBW
 Required components:

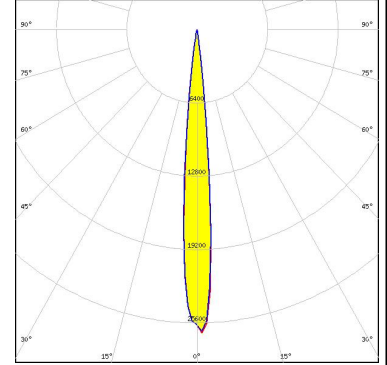

LUMILEDS

LED LUXEON Rubix
 FWHM / FWTM 4.0° / 10.0°
 Efficiency 95 %
 Peak intensity 114 cd/lm
 LEDs/each optic 1
 Light colour Blue
 Required components:

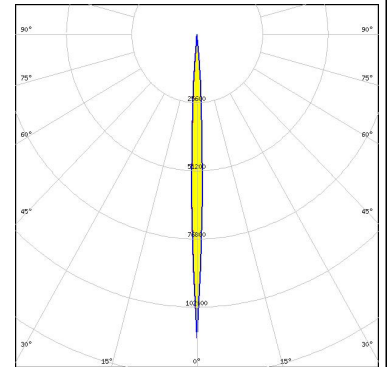

LUMILEDS

LED LUXEON V
 FWHM / FWTM 8.0° / 17.0°
 Efficiency 95 %
 Peak intensity 30.9 cd/lm
 LEDs/each optic 1
 Light colour White
 Required components:

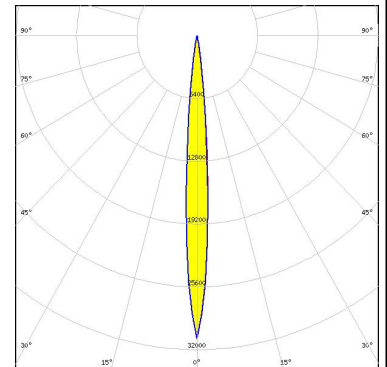

OPTICAL RESULTS (SIMULATED):



LED SBT-90
 FWHM / FWTM 8.0° / 18.0°
 Efficiency 97 %
 Peak intensity 33.1 cd/lm
 LEDs/each optic 1
 Light colour White
 Required components:

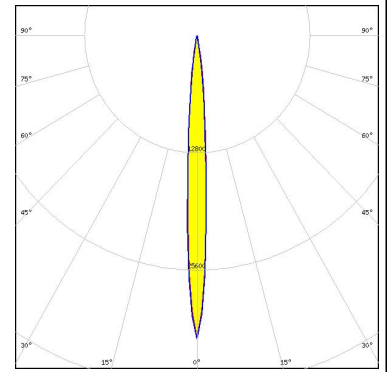

LED SFT-40-WCS
 FWHM / FWTM 6.0° / 12.0°
 Efficiency 96 %
 Peak intensity 74.7 cd/lm
 LEDs/each optic 1
 Light colour White
 Required components:

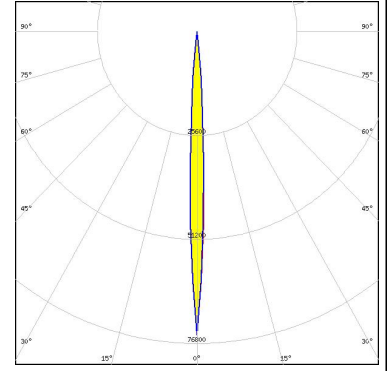

LED SFT-70X-WCS
 FWHM / FWTM 6.0° / 14.0°
 Efficiency 97 %
 Peak intensity 49.1 cd/lm
 LEDs/each optic 1
 Light colour White
 Required components:

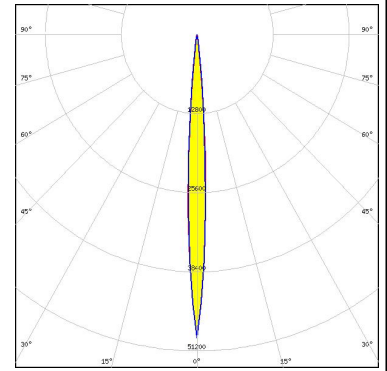

LED SST-40
 FWHM / FWTM 8.0° / 16.0°
 Efficiency 97 %
 Peak intensity 31.7 cd/lm
 LEDs/each optic 1
 Light colour White
 Required components:

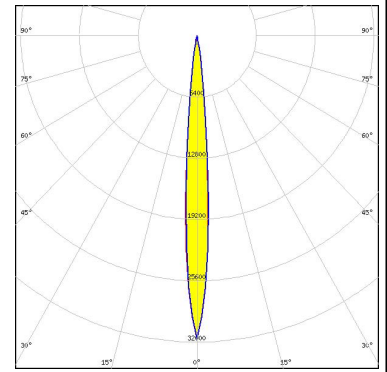

OPTICAL RESULTS (SIMULATED):

OSRAM <small>Opto Semiconductors</small>	<p>LED Duris S5 (Single chip)</p> <p>FWHM / FWTM 4.0° / 10.0°</p> <p>Efficiency 95 %</p> <p>Peak intensity 106 cd/lm</p> <p>LEDs/each optic 1</p> <p>Light colour Red</p> <p>Required components:</p>	
OSRAM <small>Opto Semiconductors</small>	<p>LED Duris S5 (Single chip)</p> <p>FWHM / FWTM 4.0° / 10.0°</p> <p>Efficiency 95 %</p> <p>Peak intensity 101.9 cd/lm</p> <p>LEDs/each optic 1</p> <p>Light colour Green</p> <p>Required components:</p>	
OSRAM <small>Opto Semiconductors</small>	<p>LED OSTAR Projection Compact (KW.CSLNM1.TG)</p> <p>FWHM / FWTM 4.0° / 8.0°</p> <p>Efficiency 94 %</p> <p>Peak intensity 139.7 cd/lm</p> <p>LEDs/each optic 1</p> <p>Light colour White</p> <p>Required components:</p>	
OSRAM <small>Opto Semiconductors</small>	<p>LED SFH 4717AS</p> <p>FWHM / FWTM 6.7° / 14.5°</p> <p>Efficiency 94 %</p> <p>Peak intensity 46.5 cd/lm</p> <p>LEDs/each optic 1</p> <p>Light colour White</p> <p>Required components:</p>	

OPTICAL RESULTS (SIMULATED):

OSRAM

Opto Semiconductors

LED SFH 4727AS
 FWHM / FWTM 6.7° / 14.5°
 Efficiency 94 %
 Peak intensity 47 cd/lm
 LEDs/each optic 1
 Light colour White
 Required components:

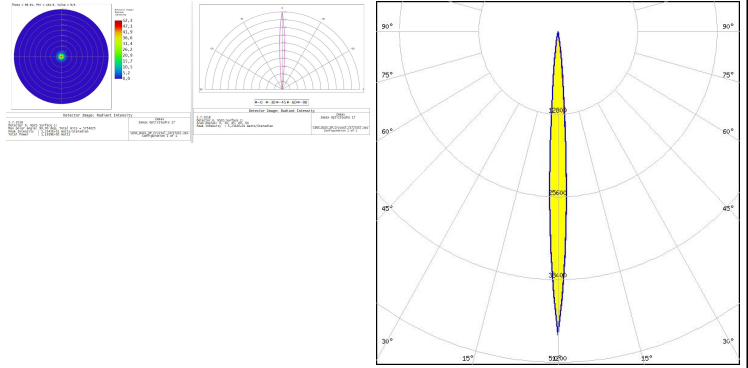

SAMSUNG

LED LH351B
 FWHM / FWTM 6.0° / 14.0°
 Efficiency 96 %
 Peak intensity 54.7 cd/lm
 LEDs/each optic 1
 Light colour White
 Required components:

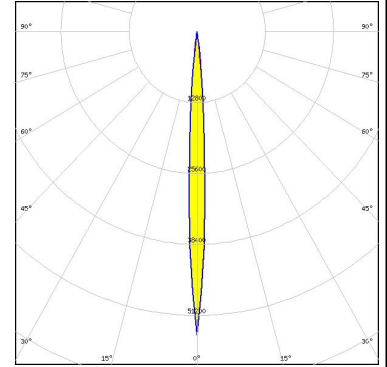

SAMSUNG

LED LH351C
 FWHM / FWTM 6.0° / 14.0°
 Efficiency 96 %
 Peak intensity 47.7 cd/lm
 LEDs/each optic 1
 Light colour White
 Required components:

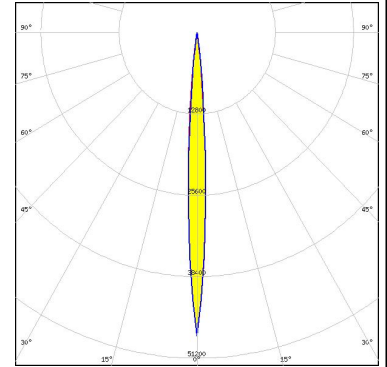

SEOUL SEMICONDUCTOR

LED Z8Y50P
 FWHM / FWTM 14.0° / 26.0°
 Efficiency 97 %
 Peak intensity 13.3 cd/lm
 LEDs/each optic 1
 Light colour White
 Required components:

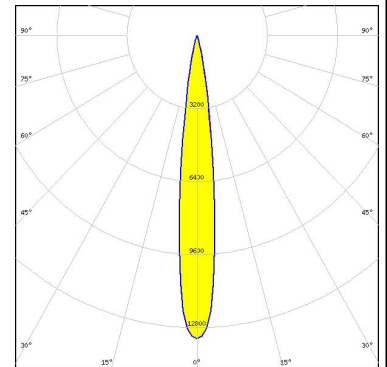

GENERAL INFORMATION:

NOTE: The typical beam angle will be changed by different color, chip size and chip position tolerance. The typical total beam angle is the full angle measured where the luminous intensity is half of the peak value.

MATERIALS:

As part of our continuous research and improvement processes, and to ensure the best possible quality and availability of our products, LEDiL reserves the right to change material grades without notice.

PRODUCT DATA USER AGREEMENT AND DISCLAIMER:

The measured data in the provided downloadable LEDiL Product Datasheets and Mechanical 2D-Drawings is rounded and provided as reference for planning. LEDiL Oy's optical specifications have been verified by conducting performance testing of the products in accordance with the company's quality system. The reported data are averaged results of multiple measurements with typical variation. LEDiL Oy reserves the right to without prior notification make changes and improvements to its products.

LEDiL Oy assumes neither warranty, nor guarantee nor any other liability of any kind for the contents and correctness of the provided data. The provided data has been generated with highest diligence but the provided data may in reality not represent the complete possible variation range of all intrinsic parameters. Therefore, in certain cases a deviation from the provided data could occur.

LEDiL Oy reserves the right to undertake technical changes of its products without further notification which could lead to changes in the provided data. LEDiL Oy assumes no liability of any kind for the possible deviation from any provided data or any other damage resulting from the usage of the provided data.

The user agrees to this disclaimer and user agreement with the download or usage of the provided files.

LEDiL Oy

Joensuunkatu 13
FI-24240 SALO
Finland

LEDiL Inc.

228 West Page Street
Suite D
Sycamore IL 60178
USA

Ledil Optics Technology (Shenzhen) Co., Ltd.

405 , Block B
Casic Motor Building
Shenzhen 518057
P.R.CHINA

Local sales and technical support

[www.ledil.com/
where_to_buy](http://www.ledil.com/where_to_buy)

Shipping locations

Salo, Finland
Hong Kong, China

Distribution Partners

[www.ledil.com/
where_to_buy](http://www.ledil.com/where_to_buy)