

Schottky Rectifier, 9 A



DO-204AR



FEATURES

- 150 °C T_J operation
- Low forward voltage drop
- High frequency operation
- High purity, high temperature epoxy encapsulation for enhanced mechanical strength and moisture resistance
- Guard ring for enhanced ruggedness and long term reliability
- Compliant to RoHS Directive 2002/95/EC
- Designed and qualified for commercial level
- Halogen-free according to IEC 61249-2-21 definition (-M3 only)



PRODUCT SUMMARY	
Package	DO-204AR
I _{F(AV)}	9 A
V _R	30 V, 35 V, 40 V, 45 V
V _F at I _F	0.42 V
I _{RM} max.	70 mA at 125 °C
T _J max.	150 °C
Diode variation	Single die
E _{AS}	12 mJ

DESCRIPTION

The VS-90SQ... axial leaded Schottky rectifier series has been optimized for very low forward voltage drop, with moderate leakage. The proprietary barrier technology allows for reliable operation up to 150 °C junction temperature. Typical applications are in switching power supplies, converters, freewheeling diodes, and reverse battery protection.

MAJOR RATINGS AND CHARACTERISTICS			
SYMBOL	CHARACTERISTICS	VALUES	UNITS
I _{F(AV)}	Rectangular waveform	9	A
V _{R(RM)}	Range	30 to 45	V
I _{FSM}	t _p = 5 μs sine	2150	A
V _F	9 Apk, T _J = 125 °C	0.42	V
T _J	Range	- 55 to 150	°C

VOLTAGE RATINGS						
PARAMETER	SYMBOL	VS-90SQ030 VS-90SQ030-M3	VS-90SQ035 VS-90SQ035-M3	VS-90SQ040 VS-90SQ040-M3	VS-90SQ045 VS-90SQ045-M3	UNITS
Maximum DC reverse voltage	V _R	30	35	40	45	V
Maximum working peak reverse voltage	V _{R(WM)}					

ABSOLUTE MAXIMUM RATINGS					
PARAMETER	SYMBOL	TEST CONDITIONS		VALUES	UNITS
Maximum average forward current See fig. 5	I _{F(AV)}	50 % duty cycle at T _C = 69 °C, rectangular waveform		9	A
Maximum peak one cycle non-repetitive surge current See fig. 7	I _{FSM}	5 μs sine or 3 μs rect. pulse	Following any rated load condition and with rated V _{RRM} applied	2150	
		10 ms sine or 6 ms rect. pulse		340	
Non-repetitive avalanche energy	E _{AS}	T _J = 25 °C, I _{AS} = 1.8 A, L = 7.4 mH		12	mJ
Repetitive avalanche current	I _{AR}	Current decaying linearly to zero in 1 μs Frequency limited by, T _J maximum V _A = 1.5 x V _R typical		1.8	A



ELECTRICAL SPECIFICATIONS					
PARAMETER	SYMBOL	TEST CONDITIONS		VALUES	UNITS
Maximum forward voltage drop See fig. 1	$V_{FM}^{(1)}$	9 A	$T_J = 25\text{ }^\circ\text{C}$	0.48	V
		18 A		0.57	
		9 A	$T_J = 125\text{ }^\circ\text{C}$	0.42	
		18 A		0.52	
Maximum reverse leakage current See fig. 2	$I_{RM}^{(1)}$	$T_J = 25\text{ }^\circ\text{C}$	$V_R = \text{Rated } V_R$	1.75	mA
		$T_J = 125\text{ }^\circ\text{C}$		70	
Maximum junction capacitance	C_T	$V_R = 5 V_{DC}$, (test signal range 100 kHz to 1 MHz) $25\text{ }^\circ\text{C}$		900	pF
Typical series inductance	L_S	Measured lead to lead 5 mm from body		10.0	nH
Maximum voltage rate of change	dV/dt	Rated V_R		10 000	V/ μs

Note

(1) Pulse width < 300 μs , duty cycle < 2 %

THERMAL - MECHANICAL SPECIFICATIONS					
PARAMETER	SYMBOL	TEST CONDITIONS		VALUES	UNITS
Maximum junction and storage temperature range	T_J, T_{Stg}			- 55 to 150	$^\circ\text{C}$
Maximum thermal resistance, junction to lead	R_{thJL}	DC operation; see fig. 4 1/8" lead length		8.0	$^\circ\text{C/W}$
Typical thermal resistance, junction to air	R_{thJA}			44	
Approximate weight				1.4	g
				0.049	oz.
Marking device		Case style DO-204AR (JEDEC)		90SQ030	
				90SQ035	
				90SQ040	
				90SQ045	

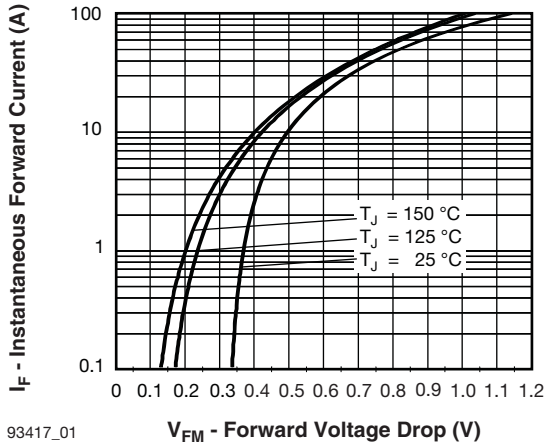

93417_01

Fig. 1 - Maximum Forward Voltage Drop Characteristics

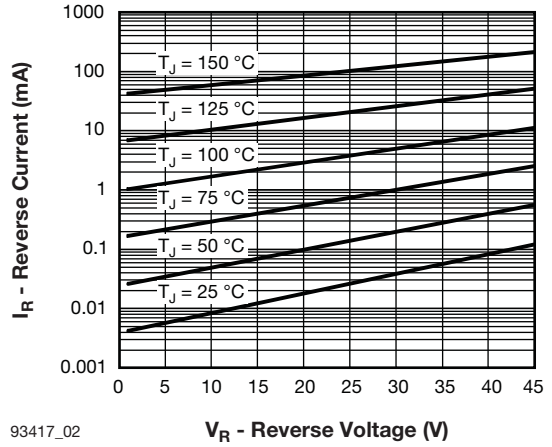

93417_02

Fig. 2 - Typical Values of Reverse Current vs. Reverse Voltage

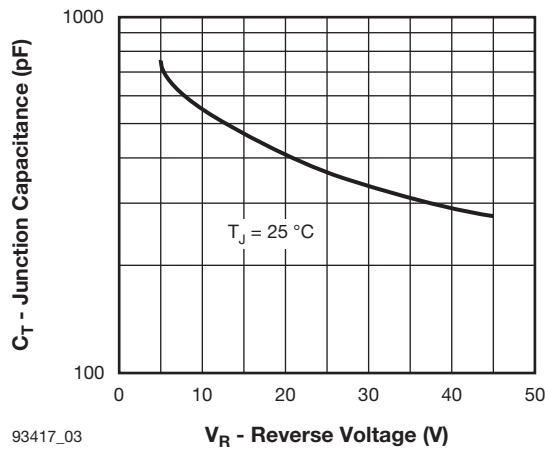

93417_03

Fig. 3 - Typical Junction Capacitance vs. Reverse Voltage

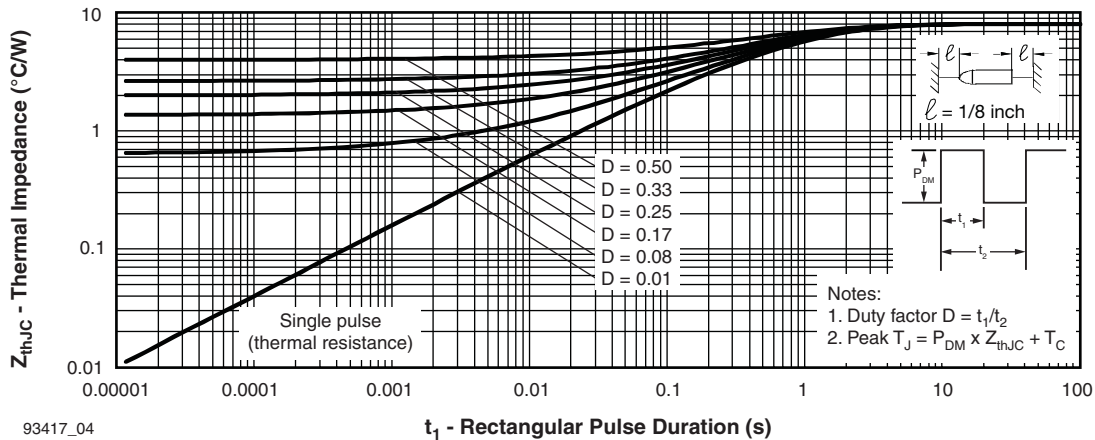

93417_04

Fig. 4 - Maximum Thermal Impedance Z_{thJL} Characteristics

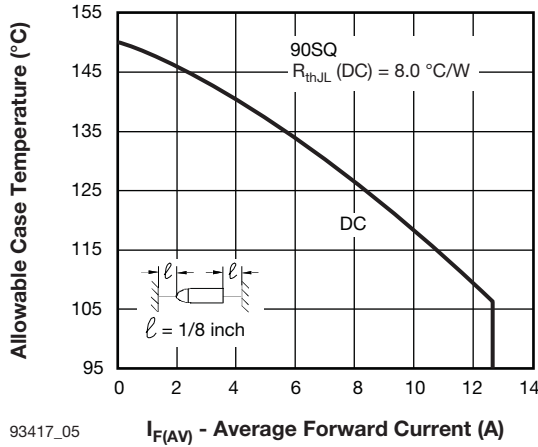

93417_05

Fig. 5 - Maximum Allowable Case Temperature vs. Average Forward Current

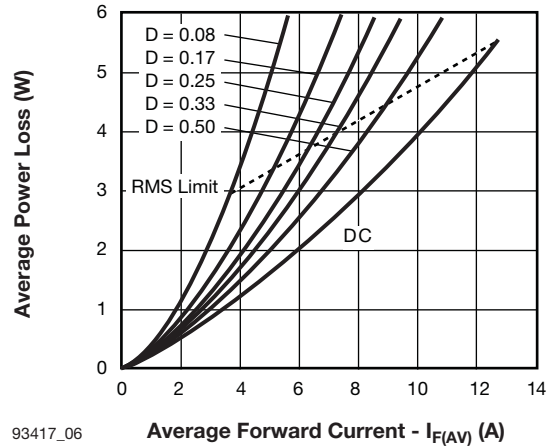

93417_06

Fig. 6 - Forward Power Loss Characteristics

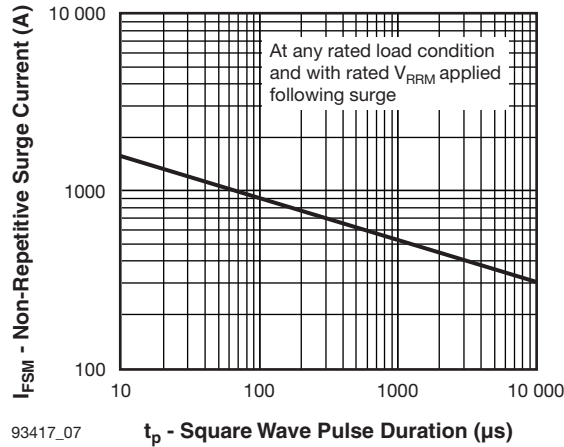

93417_07

Fig. 7 - Maximum Non-Repetitive Surge Current

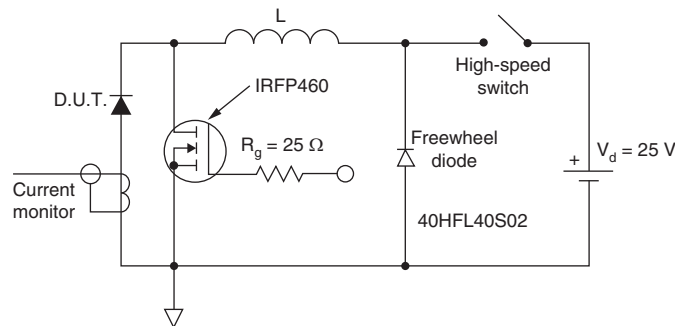
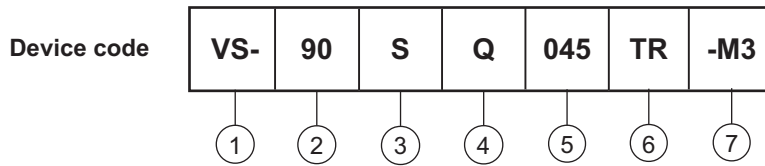

Fig. 8 - Unclamped Inductive Test Circuit



ORDERING INFORMATION TABLE



- 1** - Vishay Semiconductors product
- 2** - 90 = Current x 10
- 3** - S = DO-204AR
- 4** - Q = Schottky Q.. series
- 5** - Voltage rating

030 = 30 V
035 = 35 V
040 = 40 V
045 = 45 V
- 6** - • TR = Tape and reel package
• None = Bulk package
- 7** - Environmental digit
 - None = Lead (Pb)-free and RoHS compliant
 - -M3 = Halogen-free, RoHS compliant, and terminations lead (Pb)-free

ORDERING INFORMATION (Example)			
PREFERRED P/N	QUANTITY PER T/R	MINIMUM ORDER QUANTITY	PACKAGING DESCRIPTION
VS-90SQ030	300	300	Bulk
VS-90SQ030TR	1500	1500	Tape and reel
VS-90SQ030-M3	300	300	Bulk
VS-90SQ030TR-M3	1500	1500	Tape and reel
VS-90SQ035	300	300	Bulk
VS-90SQ035TR	1500	1500	Tape and reel
VS-90SQ035-M3	300	300	Bulk
VS-90SQ035TR-M3	1500	1500	Tape and reel
VS-90SQ040	300	300	Bulk
VS-90SQ040TR	1500	1500	Tape and reel
VS-90SQ040-M3	300	300	Bulk
VS-90SQ040TR-M3	1500	1500	Tape and reel
VS-90SQ045	300	300	Bulk
VS-90SQ045TR	1500	1500	Tape and reel
VS-90SQ045-M3	300	300	Bulk
VS-90SQ045TR-M3	1500	1500	Tape and reel

LINKS TO RELATED DOCUMENTS	
Dimensions	www.vishay.com/doc?95243
Part marking information	www.vishay.com/doc?95325
Packaging information	www.vishay.com/doc?95332



Axial DO-204AR

DIMENSIONS in millimeters (inches)

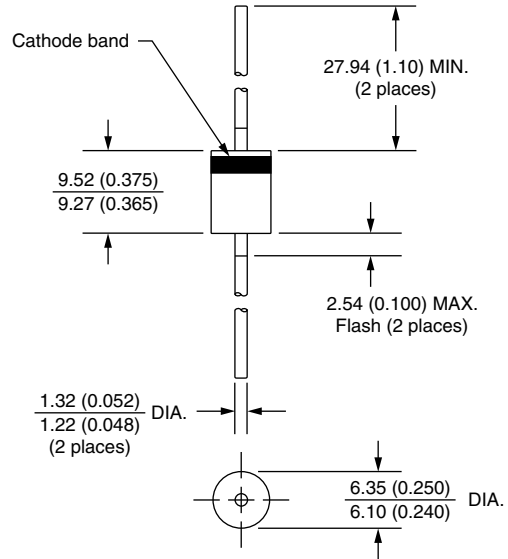



Disclaimer

ALL PRODUCT, PRODUCT SPECIFICATIONS AND DATA ARE SUBJECT TO CHANGE WITHOUT NOTICE TO IMPROVE RELIABILITY, FUNCTION OR DESIGN OR OTHERWISE.

Vishay Intertechnology, Inc., its affiliates, agents, and employees, and all persons acting on its or their behalf (collectively, "Vishay"), disclaim any and all liability for any errors, inaccuracies or incompleteness contained in any datasheet or in any other disclosure relating to any product.

Vishay makes no warranty, representation or guarantee regarding the suitability of the products for any particular purpose or the continuing production of any product. To the maximum extent permitted by applicable law, Vishay disclaims (i) any and all liability arising out of the application or use of any product, (ii) any and all liability, including without limitation special, consequential or incidental damages, and (iii) any and all implied warranties, including warranties of fitness for particular purpose, non-infringement and merchantability.

Statements regarding the suitability of products for certain types of applications are based on Vishay's knowledge of typical requirements that are often placed on Vishay products in generic applications. Such statements are not binding statements about the suitability of products for a particular application. It is the customer's responsibility to validate that a particular product with the properties described in the product specification is suitable for use in a particular application. Parameters provided in datasheets and/or specifications may vary in different applications and performance may vary over time. All operating parameters, including typical parameters, must be validated for each customer application by the customer's technical experts. Product specifications do not expand or otherwise modify Vishay's terms and conditions of purchase, including but not limited to the warranty expressed therein.

Except as expressly indicated in writing, Vishay products are not designed for use in medical, life-saving, or life-sustaining applications or for any other application in which the failure of the Vishay product could result in personal injury or death. Customers using or selling Vishay products not expressly indicated for use in such applications do so at their own risk. Please contact authorized Vishay personnel to obtain written terms and conditions regarding products designed for such applications.

No license, express or implied, by estoppel or otherwise, to any intellectual property rights is granted by this document or by any conduct of Vishay. Product names and markings noted herein may be trademarks of their respective owners.

Material Category Policy

Vishay Intertechnology, Inc. hereby certifies that all its products that are identified as RoHS-Compliant fulfill the definitions and restrictions defined under Directive 2011/65/EU of The European Parliament and of the Council of June 8, 2011 on the restriction of the use of certain hazardous substances in electrical and electronic equipment (EEE) - recast, unless otherwise specified as non-compliant.

Please note that some Vishay documentation may still make reference to RoHS Directive 2002/95/EC. We confirm that all the products identified as being compliant to Directive 2002/95/EC conform to Directive 2011/65/EU.

Vishay Intertechnology, Inc. hereby certifies that all its products that are identified as Halogen-Free follow Halogen-Free requirements as per JEDEC JS709A standards. Please note that some Vishay documentation may still make reference to the IEC 61249-2-21 definition. We confirm that all the products identified as being compliant to IEC 61249-2-21 conform to JEDEC JS709A standards.