

DKSV165

Normally closed, direct lift, 2-way solenoid valve with brass body and 3/4" connections

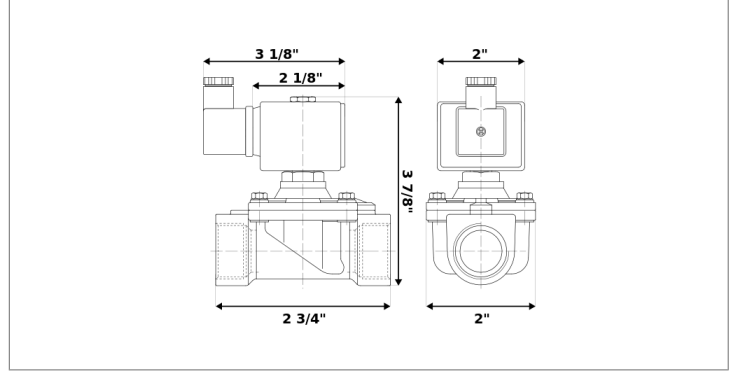

Valve	
Pipe size:	3/4" NPT
Operating pressure:	0–200 psi
Flow coefficient:	2.8 Cv
Media temperature:	15–195 °F
Ambient temperature:	-5–140 °F
Suggested usage:	Air, inert gas, water
Operation:	2-way, normally closed solenoid valve
Mechanism:	Direct lift
Manual override:	No
Pipe gender:	Female
Orifice size:	5/8"
Design pressure:	230 psi
Vacuum rating:	0.001 Torr
Media viscosity:	12 cSt

Materials	
Body:	Brass
Seal:	Buna-N/polyamide rubber (NBR/PA)
Orifice:	Brass
Core tube:	Stainless steel 300
Fixed core:	Stainless steel 400
Plunger:	Stainless steel 400
Spring:	Stainless steel 300
Shading ring:	Copper

Electrical	
Power:	24 V dc
Wattage:	14 W
Connection:	Cable gland (PG9)
Consumption:	0.58 A
Voltage tolerances:	+10% -5%
Coil inner diameter:	1/2"
Coil molding:	Polyethylene (PET)
Coil rating:	-5–355 °F (Class H)
Duty cycle:	Continuous, 100% ED
Enclosure:	NEMA 4, IP65

Spare parts		
CORE TUBE	REPAIR KIT	COIL/CONNECTOR
AT-H091	RK-H0Y2	C-H29
		
<ul style="list-style-type: none"> Core tube 	<ul style="list-style-type: none"> O-ring Plunger and diaphragm assembly 	<ul style="list-style-type: none"> 24 V dc electrical coil Cable gland connector