

Medical AC-DC Enclosed Power Supply

24V 200W 2"x4" High Density / MDS-200APB24 AA

MDS-200APB24 AA



Highlights & Features

- Safety Approvals to IEC 60601-1 3.1rd ed. & IEC 60950-1
- Compliant with IEC 60601-1-2 4th Ed. Requirements
- Power Good Signal
- Up to 800K Hours MTBF
- Up to 140W convection, 200W forced air

Safety Standards



CB Certified for worldwide use

Model Number: MDS-200APB24 AA

Unit Weight: 200g(0.441lb)

Dimensions (W x L x H): 50.8 x 101.6 x 35.6mm
(2x4x1.4 inch)

General Description

Delta's new MDS-200APB24 AA internal open frame power supply comes with universal AC input range from 90Vac to 264Vac. Other features include low leakage, Type BF Patient Access Leakage Currents, and electric shock protection compliance with 2 x MOPP requirements. The MDS-200APB24 AA is certified for EMC standards according to EN 55011 for industrial, scientific and medical (ISM) radio-frequency equipment; and, EN 55022 for Industrial Technology Equipment (ITE) radio-frequency equipment. In addition, only recognized Japanese capacitors are used to ensure long product life.

The MDS-200APB24 AA comes with both medical and ITE safety approvals, including UL/CE/CCC (5000meters), and CB certification. Designs are compliant with RoHS Directive 2011/65/EU for environmental protection.

Model Information

| Model Number | Input Voltage | Output Voltage | Convection Current Output | Forced Air Current Output |
|----------------|---------------|----------------|---------------------------|---------------------------|
| MDS-200APB24AA | 90-264Vac | 24Vdc | 0-5.83A | 0-8.33A* |

*With 5.5CFM forced air

Model Numbering

| MDS | 200 | A | P | B | 24 | AA |
|----------------------------|--------------------------------------------------------------------------|---------------------|-------------------------------|------------------------------------|------------------------------|---------------|
| Delta Medical power Supply | Max wattage in the product Series. Maybe lower at some voltage. 200→200W | Family Code A~ Z | Product Type P: Open Frame | Input Type Code B: 3pin Class I | Output Voltage 24 for 24V | Revision code |

Medical AC-DC Enclosed Power Supply

24V 200W 2"x4" High Density / MDS-200APB24 AA

Specifications

Input Ratings / Characteristics

| | |
|---------------------------------------------------------------------------|---------------------------------------------------------|
| Nominal Input Voltage | 100-240Vac |
| Input Voltage Range | 90-264Vac |
| Nominal Input Frequency | 50-60Hz |
| Input Frequency Range | 47-63Hz |
| Input Current (max) | 2.5A |
| Input Surge Voltage (max) | 300Vac for 100ms |
| Full load Efficiency (typ.) | 92% @ 115Vac/60Hz 93% @ 230Vac/50Hz, Reference Fig.1 |
| Standby Power (max) | 0.5W @ 115Vac/60Hz, 230Vac/50Hz |
| Inrush Current (max) | 60A@230Vac, cold start |
| Input-PE(protective earth) leakage current(max) | 0.1mA @ NC, 0.3mA @ SFC1) |
| Output-PE(protective earth) leakage current for Type BF application (max) | 0.1mA @ NC, 0.5mA @ SFC 1) |
| Power Factor (min) | 0.95 @ 115V/50Hz, 230V/50Hz, full load |

1) NC: normal condition, SFC: single fault condition

Leakage Current

| Input-PE Leakage Current | 100Vac/60Hz(Typ) | 264Vac/60Hz(Typ) | Delta Limit | IEC60601-1 Limit |
|---------------------------------------------------|------------------|------------------|-------------|------------------|
| Normal Condition | 19.5uA | 45.0uA | 100uA max | 5000uA max |
| Single Fault Condition | 44.8uA | 153.0uA | 300uA max | 10000uA max |
| Output-PE Leakage Current for Type BF application | | | | |
| Normal Condition | 38.3uA | 81.5uA | 100uA max | 100uA max |
| Single Fault Condition | 43.4uA | 129.4uA | 500uA max | 500uA max |

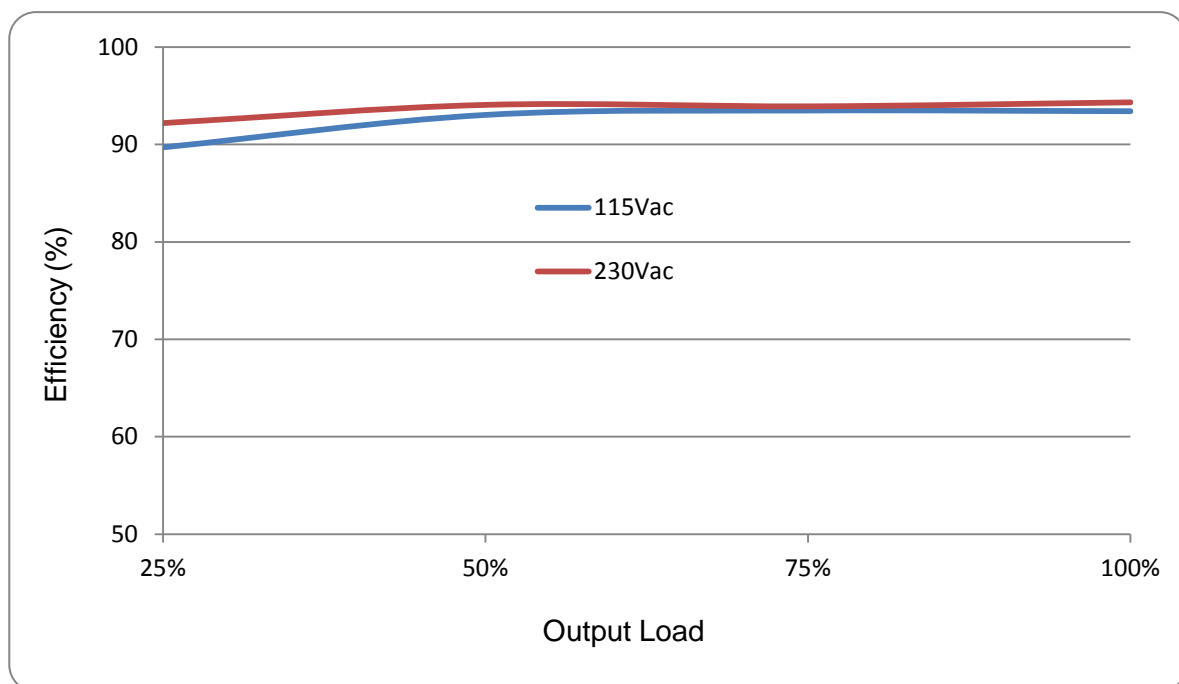

Fig.1 Efficiency versus output load

Medical AC-DC Enclosed Power Supply

24V 200W 2"x4" High Density / MDS-200APB24 AA

Output Ratings / Characteristics

| | |
|------------------------------------------------------|---------------------------------------------|
| Nominal Output Voltage (Vrated) | 24V |
| Total Regulation (max.) | ±3% |
| Output Power | 200W 5.5CFM air, up to 140W convection air |
| Line Regulation (max) | ±0.5% |
| Load Regulation (max) | ±2.5% |
| Ripple & Noise (typ.) | 1%pk-pkVrated @ Full load, Reference Fig. 2 |
| Start-up Time(max) | 2000ms@115Vac |
| Hold-up Time(min) | 12ms@115Vac, tested with 130W load |
| Dynamic Response(Overshoot & Undershoot O/P Voltage) | ±5% @50-100% load |
| Capacitive load (max) | 1000uF @200W 1500uF@140W |
| Rise time (max) | 100ms |

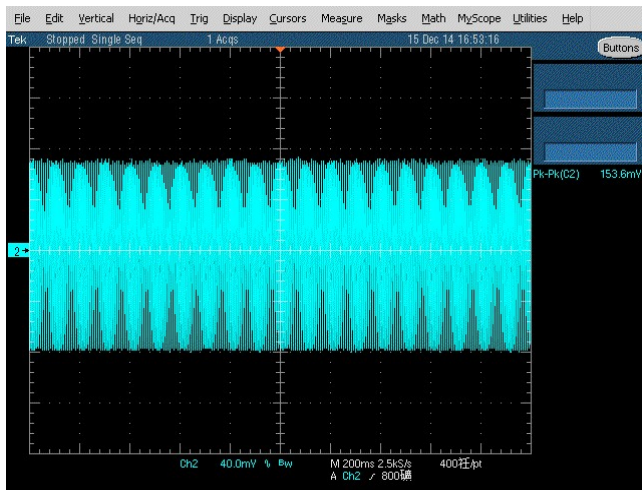

(a) 115V (measured value=153.6mV)

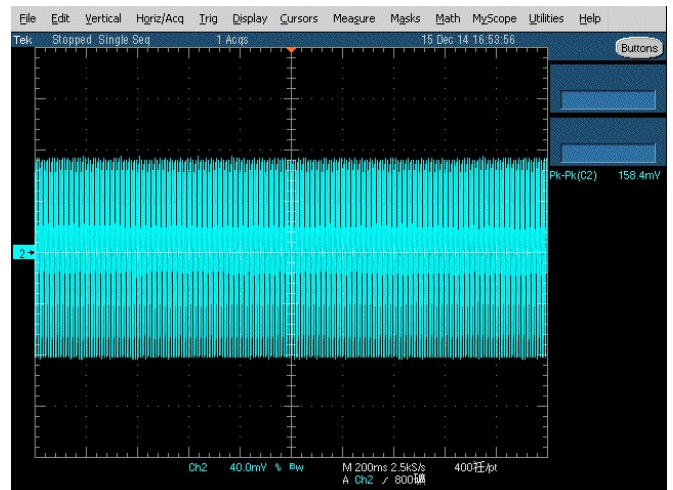

(b) 230V(measured value=158.4mV)

Fig.2 Ripple & Noise example, 20MHz BW

Ripple & Noise measurement circuit

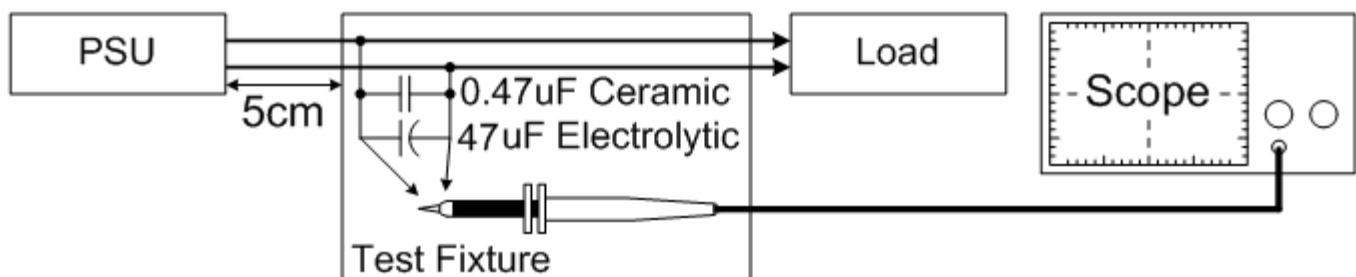

Medical AC-DC Enclosed Power Supply

24V 200W 2"x4" High Density / MDS-200APB24 AA

Mechanical

| | |
|----------------------------|---------------------------------|
| Case Cover | NA |
| Dimensions(W x L x H typ.) | 50.8x101.6x35.6mm (2x4x1.4inch) |
| Unit Weight | 200g(0.441lb) |
| Indicator | NA |
| Cooling System | NA |

Environment

| | | |
|-----------------------------|-----------|-----------------------------------------------------------------------------------------------------------------------------------------|
| Surrounding Air Temperature | Operating | Absolute Max -10°C to+70°C, supported power linearly de-rate from 50°C to 50% rated up to 70°C Note: see power de-rating curve |
| | Storage | -40°C to+85°C |
| Operating Humidity | | 5-95% RH (Non-Condensing) |
| Operating Altitude | | 5,000 meters (16402 feet) |
| Shock Test (Non-Operating) | | 50G, 11ms, 3 shocks for each direction |
| Vibration (Operating) | | 5-500Hz, 2Grms, 15 minute for each three axis |

Power De-rating curve

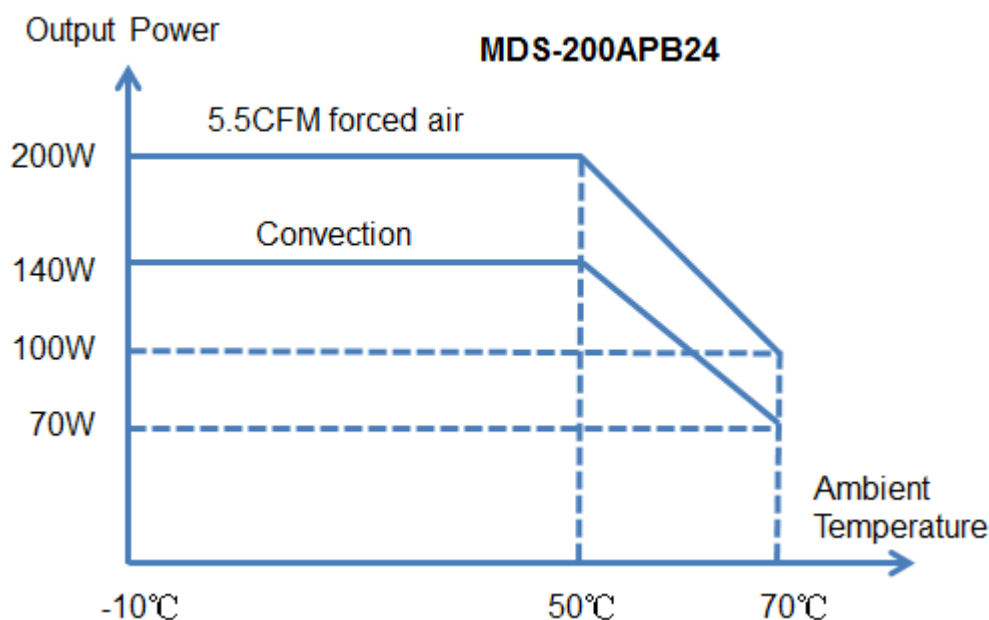

Medical AC-DC Enclosed Power Supply

24V 200W 2"x4" High Density / MDS-200APB24 AA

Protections

| | |
|------------------------------|-------------------------------------------------------------------------------|
| Overvoltage (max) | 125% of rated voltage, Latch Mode |
| Overload / Overcurrent (max) | Main output 160% of rated current Hiccup Mode(Non-Latching, Auto-Recovery) |
| Over Temperature | Latch Mode |
| Short Circuit | Hiccup Mode, (Non-Latching, Auto-Recovery) |

Reliability

| | |
|--------------------------------------------------------------------|-------------------------------------|
| MTBF(Minimum) at 115Vac, 140W, 35°C, Convection Air Flow | 800 kHrs based on Telecordia SR-332 |
| Operating life at 115Vac, 140W, ambient 25 °C, Convection Air Flow | 26,280Hrs |

Safety Standards / Directives

| | |
|--------------------|----------------------------------------------------------------------------------------------------------------------------------------------------------------------------------------------------------------------------|
| Medical Safety | IEC60601-1 2 nd and 3.1 rd edition CB report IEC60601-1 edition 3.1 rd (2012), EN60601-1 (2006) + A11 + A1 + A12, CAN/CSA-C22.2 NO. 60601-1:14, ANSI/AAMI ES60601-1:2005/(R)2012 |
| ITE Safety | IEC60950-1 CB report TUV60950-1 UL60950-1+CAN/CSA60950-1 GB4943.1-2011, GB9254-2008, GB17625.1-2003 |
| CE | MDD Directive 93/42/EEC |
| Environmental | RoHS Directive 2011/65/EU Compliant |
| Galvanic Isolation | Input to/Output (2XMOPP) 4000 Vac Input to/Ground(1XMOPP) 1500Vac ¹⁾ Output to/Ground(1XMOPP) 1500Vac (Type BF application rated) |

1) PSU can support PoE applications with Primary to FG 2500Vac test.

Medical AC-DC Enclosed Power Supply

24V 200W 2"x4" High Density / MDS-200APB24 AA

EMC (Compliant with IEC 60601-1-2 4th Ed. Requirements)

| | | |
|-----------------------------------|---------------|-----------------------------------------------------------------------------------------------------------------------------------------------------------------------------------------------------------------------------------------------------------------------------------------------------------------------------------------------------|
| EMC / Emissions | | EN55011/EN55022,FCC Title 47:Class B |
| Harmonic Current Emissions | IEC61000-3-2 | Meet Class D limit |
| Immunity to | | |
| Voltage Flicker | IEC61000-3-3 | |
| Electrostatic Discharge | IEC61000-4-2 | Level 4 Criteria A ¹⁾ Air Discharge: 15kV Contact Discharge: 8kV |
| Radiated Field | IEC61000-4-3 | Criteria A ¹⁾ 80MHz-2700MHz, 10V/m AM modulation 385MHz-5785MHz, 28V/m Pulse mode and other modulation |
| Electrical Fast Transient / Burst | IEC61000-4-4 | Level 3 Criteria A ¹⁾ :2kV |
| Surge | IEC61000-4-5 | Level 3 Criteria A ¹⁾ Common Mode ³⁾ : 2kV Differential Mode ⁴⁾ : 1kV |
| Conducted | IEC61000-4-6 | Level 2 Criteria A ¹⁾ 150kHz-80MHz, 3Vrms, 6Vrms at ISM bands and Amateur radio bands |
| Power Frequency Magnetic Fields | IEC61000-4-8 | Criteria A ¹⁾ Magnetic field strength 30A/m |
| Voltage Dips | IEC61000-4-11 | Criteria A ¹⁾ 0% U _r , 0.5 cycle (10ms) , 0°/45°/90°/135°/180°/225°/270°/315°/360° Criteria B ²⁾ 0% U _r , 1 cycle (20ms), 0° Criteria B ²⁾ 70% U _r , 25 cycle (500ms), 0° Criteria B ²⁾ 0% U _r , 250 cycle (5000ms), 0° |

1) Criteria A: Normal performance within the specification limits

2) Criteria B: Output out of regulation, or shuts down during test. Automatically restore to normal operation after test.

3) Asymmetrical: Common mode (Line to earth)

4) Symmetrical: Differential mode (Line to line)

Medical AC-DC Enclosed Power Supply

24V 200W 2"x4" High Density / MDS-200APB24 AA

Dimensions

W x L x H: 50.8 x 101.6 x 35.6 mm

Mechanical drawing (3Pin input type)

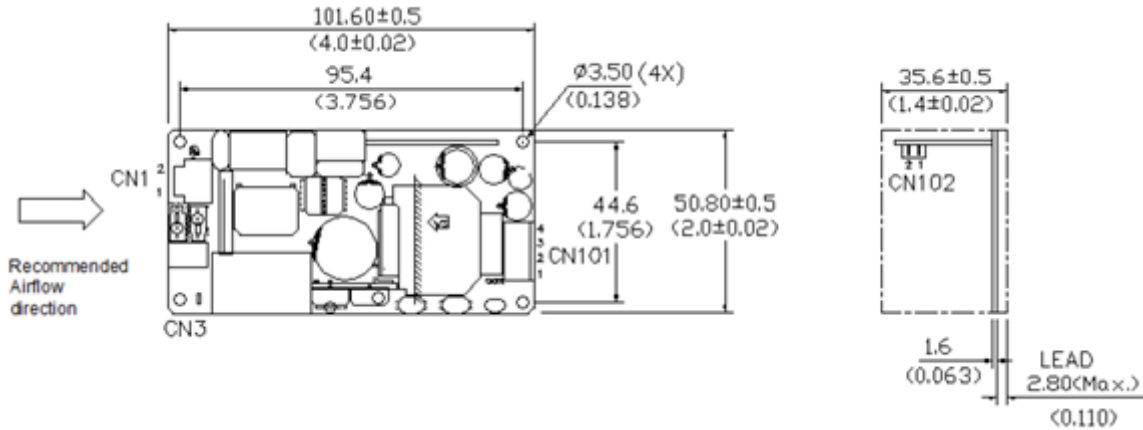

Notes

— Dimensions are in mm

| Input Connector CN1 | |
|---------------------|---------|
| Pin 1 | Neutral |
| Pin 2 | Line |

CN1 mates with Molex housing 26033031 and Molex series 6838 crimp terminals.

Input Line can also be connected to pin 1, and Input Neutral can be connected to pin 2

| Signal Connector CN102 | |
|------------------------|----------------------|
| Pin 1 | Power Good -(DC RTN) |
| Pin 2 | Power Good + |

CN102 mates with Molex housing 0874390200 and Molex 874210000 crimp terminals.

CN3: PINGOOD : JP-13T or equivalent mate with KST : FDFNYD1-187 or other applicable connectors

| Output Connector CN101 | |
|------------------------|--------|
| Pin1 | DC RTN |
| Pin2 | DC RTN |
| Pin3 | Vo |
| Pin4 | Vo |

CN101 mates with JST housing VHR-4N and JST terminal SVH-41T-P1.1.

Two mounting points in mechanical drawing need to be connected to system earth case together, Protective bonding conductor from the end product protective earth terminal (if any) can be tied to CN3 for open frame model.

Medical AC-DC Enclosed Power Supply

24V 200W 2"x4" High Density / MDS-200APB24 AA

Functions

Start-up Time

The time required for the output voltage to reach 90% of its set value, after the input voltage is applied.

Rise Time

The time required for the output voltage to change from 10% to 90% of its set value.

Hold-up Time

Hold up time is the time when the AC input collapses and output voltage retains regulation for a certain period of time. The time required for the output to reach 90% of its set value, after the input voltage is removed.

■ Graph illustrating the Start-up Time, Rise Time, and Hold-up Time

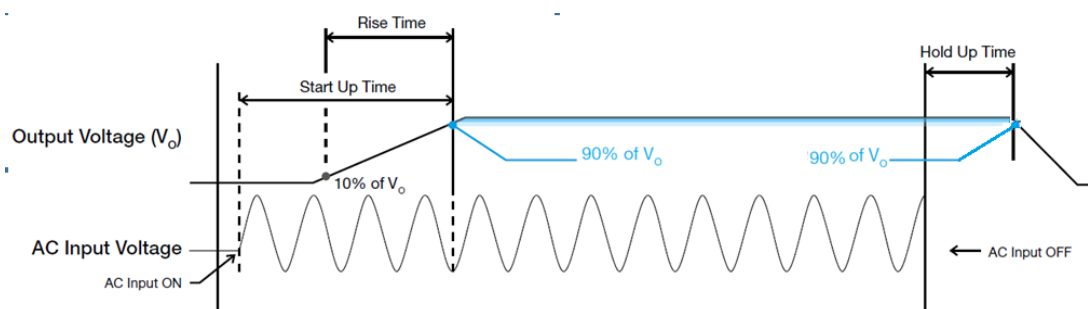

Medical AC-DC Enclosed Power Supply

24V 200W 2"x4" High Density / MDS-200APB24 AA

Dynamic Response

The power supply output voltage will remain within $\pm 5\%$ of its steady state value, when subjected to a dynamic load 50 to 100% of its rated current.

■ 50 to 100% Load

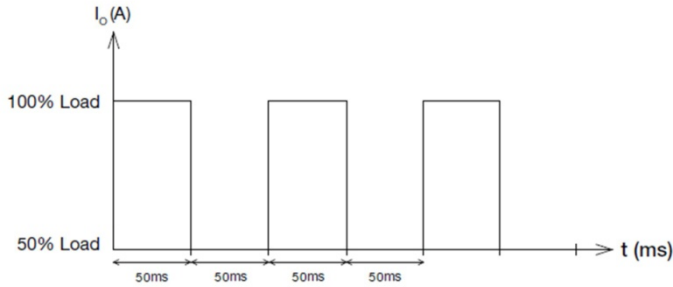

Inrush Current

Inrush current is the peak, instantaneous, input current measured and, occurs when the input voltage is first applied. For AC input voltages, the maximum peak value of inrush current will occur during the first half cycle of the applied AC voltage. This peak value decreases exponentially during subsequent cycles of AC voltage.

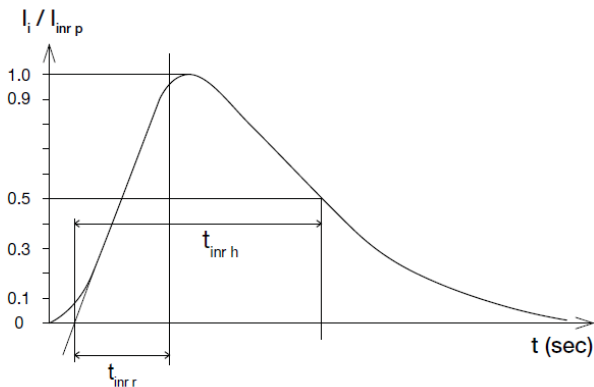

Overvoltage Protection

The power supply's overvoltage circuit will be activated when its internal feedback circuit fails. The output voltage shall not exceed its specifications defined on Page 6 under "Protections". Power supply will latch off, and require removal/re-application of input AC voltage in order to restart.

Short Circuit Protection

The power supply's output OLP/OCP function also provides protection against short circuits. When a short circuit is applied, the output current will operate in "Hiccup mode", as shown in the illustration in the OLP/OCP section on this page. The power supply will return to normal operation after the short circuit is removed.

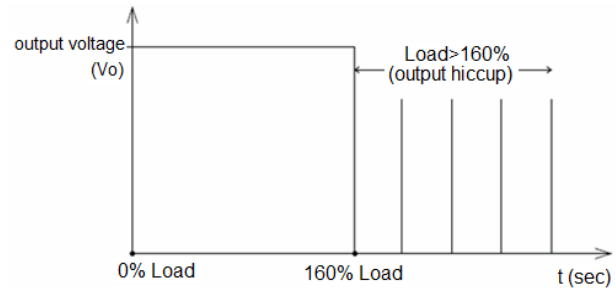

Overload & Overcurrent Protections

The power supply's Overload (OLP) and Overcurrent (OCP) Protections will be activated before output current under 160% of I_o (Max load). Upon such occurrence, V_o will start to drop. Once the power supply has reached its maximum power limit, the protection will be activated and the power supply will go into "Hiccup mode" (Auto-Recovery). The power supply will recover once the fault condition causing the OLP and OCP is removed and I_o is back within the specified limit.

Additionally, if the load is $< 160\%$ but $> 100\%$ for a prolonged period of time (depending on the load), the Over Temperature Protection (OTP) will be activated due to high temperature on critical components. Then, the power supply will be latched off, and require recycling of input voltage to restart it.

Over Temperature Protection

As mentioned above, the power supply also has Over Temperature Protection (OTP). This is activated when the overload condition persists for an extended duration and the output current is below the overload trigger point but $> 100\%$ load. In the event of a higher operating temperature condition at 100% load, the power supply will run into OTP when the surrounding air temperature is higher than the operating temperature. When activated, the output voltage will go into latch mode until the input voltage is removed; then, reapplied, and the surrounding air temperature drops to its normal operating temperature.

Medical AC-DC Enclosed Power Supply

24V 200W 2"x4" High Density / MDS-200APB24 AA

Power Good

Power Good+ pin is an open collector transistor (40V/600mA rating). A resistor (suggested value 20Kohm, 1/8W) can be added between output pin (or, other available pull-up voltage that is no greater than 30V) and the Power Good+ pin (refer to figure below). Value of pull-up resistor may have to be adjusted, depending on voltage used, and other end-use conditions of the Power Good+ pin connection to the product. When AC input is on, Power Good+ pin will be high. When AC input is off, Power Good+ pin will be low. There will be a minimum of 5 milliseconds (with 120W convection output power) between the time the power good goes to low level, and the time when the output reaches 90% of its rated value.

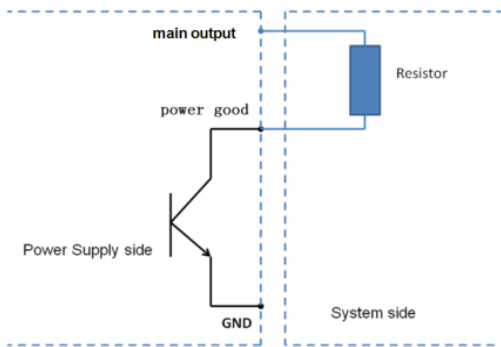
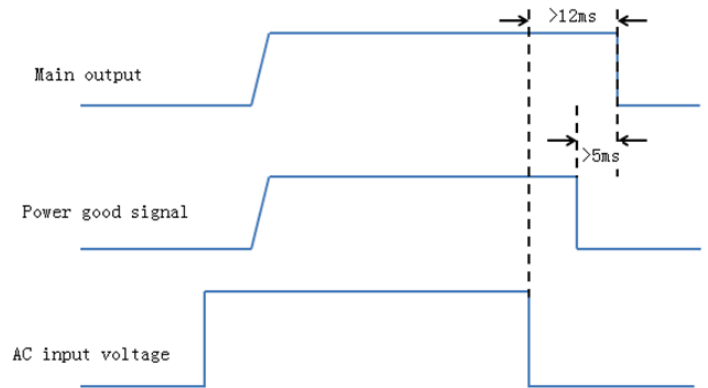

Medical AC-DC Enclosed Power Supply

24V 200W 2"x4" High Density / MDS-200APB24 AA

Certificate



All Delta Medical Power products conform to the European directive 2011/65/EU. RoHS is the abbreviation for "Restriction of the use of certain hazardous substances"



Delta has been certified as meeting the requirement of ISO 13485: 2003 and EN ISO 13485:2012 for the design and manufacture of switching power supply and adaptor for medical device.



In addition to a UL Total Certification Program (TCP) approved client laboratory for IEC60950 and IEC60065. Delta also has participated UL Client Test Data Program (CDTP) for IEC 60601