

Sensor/actuator cable - SAC-3P- 5,0-PUR/C-1L-Z - 1435551

Please be informed that the data shown in this PDF Document is generated from our Online Catalog. Please find the complete data in the user's documentation. Our General Terms of Use for Downloads are valid (<http://phoenixcontact.com/download>)



Sensor/actuator cable, 3-position, PUR halogen-free, black-gray RAL 7021, free cable end, on Valve connector C (8 mm), with 1 LED, connected with Z diode, cable length: 5 m

Your advantages

- ✓ Easy and safe: 100% electrically tested plug-in components
- ✓ Robust valve connector with Zener diode as protective circuit
- ✓ Convenient: increased machine availability thanks to quick and easy diagnostics
- ✓ Our standard: robust halogen-free PUR cable

Key Commercial Data

Packing unit	1 pc
GTIN	 4 046356 413824
GTIN	4046356413824

Technical data

Dimensions

Length of cable	5 m
Stripping length of the free conductor end	50 mm
Central screw valve connector	M2,5 x 27,5

Ambient conditions

Ambient temperature (operation)	-20 °C ... 85 °C (valve plug)
Degree of protection	IP65/IP67

General

Rated current at 40°C	4 A
Rated voltage	24 V AC
	24 V DC
Number of positions	3

Sensor/actuator cable - SAC-3P- 5,0-PUR/C-1L-Z - 1435551

Technical data

General

Color handle area	black
Insulation resistance	≥ 100 MΩ
Standards/regulations	Valve connector EN 175301-803
Status display	1 LED
Protective circuit/component	Z diode
Pulse power W_{max}	40 W (at 100 μs square-wave pulse)
Terminal voltage	70 V (at 2 mA constant current)
Reverse voltage	50 V
Overvoltage category	III
Degree of pollution	3
Torque	0.6 Nm (Valve connector)

Material

Flammability rating according to UL 94	V0
Valve plug contact material	CuSn
Valve plug contact surface material	Sn
Valve plug contact insert material	PA 6.6
Material housing valve plug	TPU
Sealing material	TPU (Seal molded)

Standards and Regulations

Standard designation	Valve connector
Standards/regulations	EN 175301-803
Flammability rating according to UL 94	V0

Cable

Cable type	PUR halogen-free black
Cable type (abbreviation)	PUR
Cable abbreviation	Li9Y11Y-HF
UL AWM style	20549
Conductor cross section	3x 0.5 mm ²
AWG signal line	20
Conductor structure signal line	28x 0.15 mm
Core diameter including insulation	1.5 mm ±0.05 mm (Signal line)
Wire colors	black 1, black 2, green/yellow
Overall twist	3 wires, twisted
External sheath, color	black-gray RAL 7021
External cable diameter D	4.5 mm ±0.2 mm
Smallest bending radius, fixed installation	22.5 mm
Number of bending cycles	15000000
Bending radius	50 mm
Traversing path	0.9 m

Sensor/actuator cable - SAC-3P- 5,0-PUR/C-1L-Z - 1435551

Technical data

Cable

Traversing rate	5 m/s
Acceleration	30 m/s ²
Outer sheath, material	PUR
Material conductor insulation	PP
Conductor material	Bare Cu litz wires
Insulation resistance	min. 20 MΩ*km
Conductor resistance	39 Ω/km (at 20 °C)
Nominal voltage, cable	≤ 300 V
Test voltage, cable	≥ 1200 V
Flame resistance	according to DIN VDE 0482
	According to DIN EN 50265-2-1
Halogen-free	in accordance with DIN VDE 0472 part 815
Other resistance	largely oil-resistant
	partly UV-resistant in accordance with DIN EN ISO 4892-2-A
Ambient temperature (operation)	-40 °C ... 80 °C (cable, fixed installation)
	-20 °C ... 80 °C (cable, flexible installation)

Environmental Product Compliance

China RoHS	Environmentally Friendly Use Period = 50
	For details about hazardous substances go to tab "Downloads", Category "Manufacturer's declaration"

Drawings

Dimensional drawing

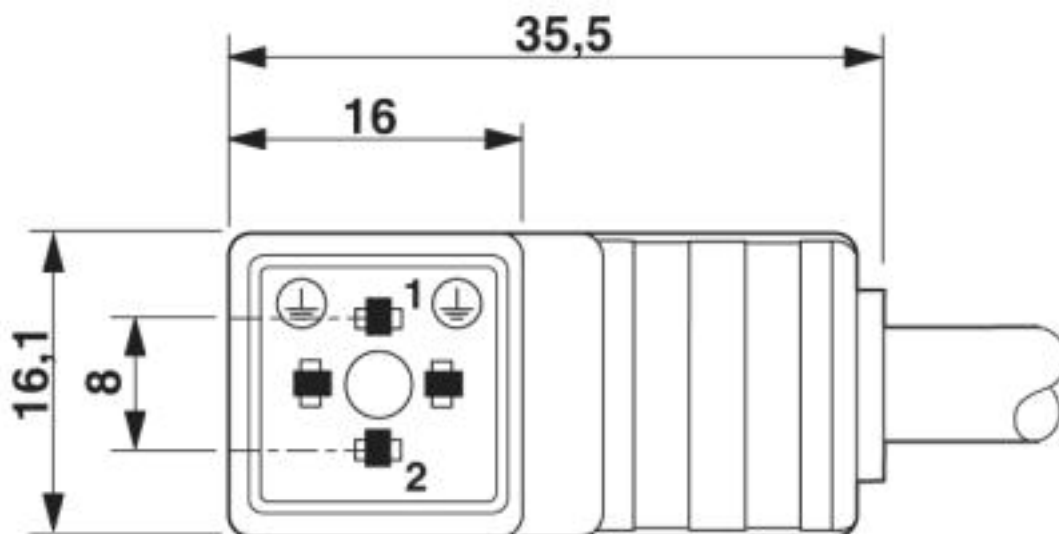

Valve connector, type C

Sensor/actuator cable - SAC-3P- 5,0-PUR/C-1L-Z - 1435551

Dimensional drawing

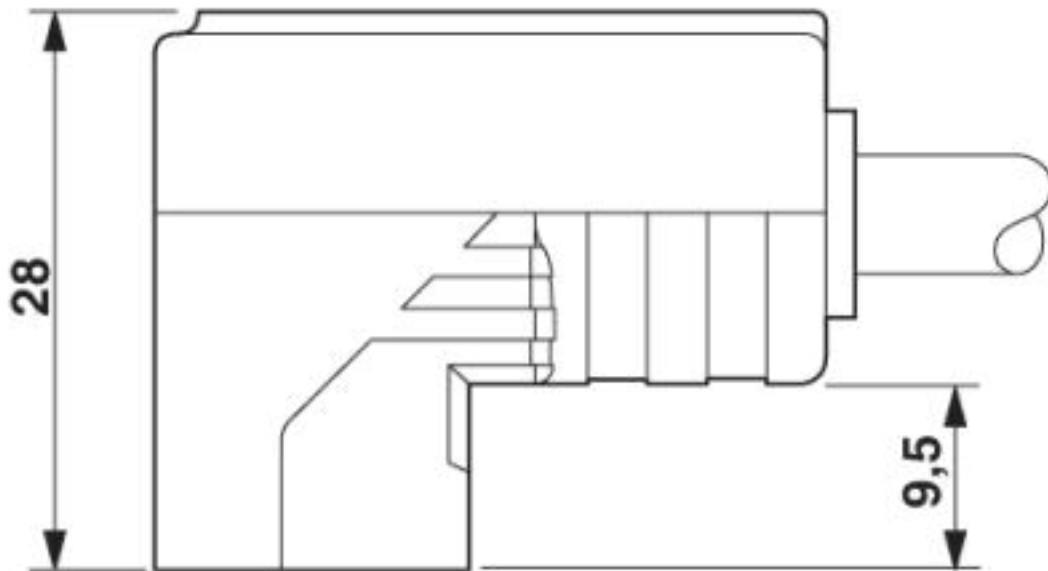

Valve connector, type C, side view

Circuit diagram

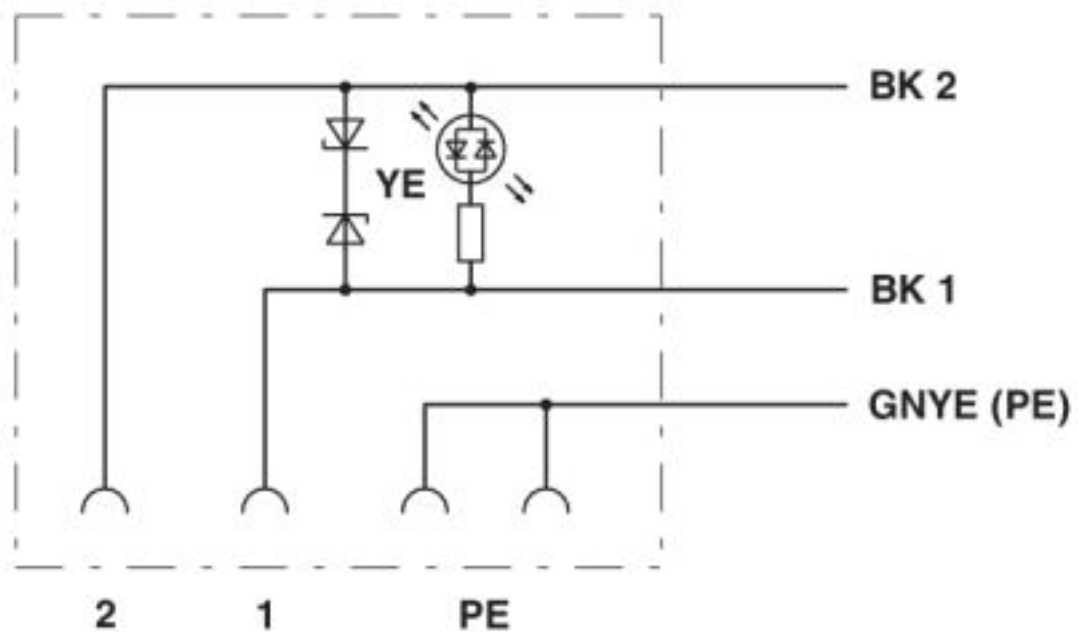

Contact assignment of the valve plug

Sensor/actuator cable - SAC-3P- 5,0-PUR/C-1L-Z - 1435551

Schematic diagram

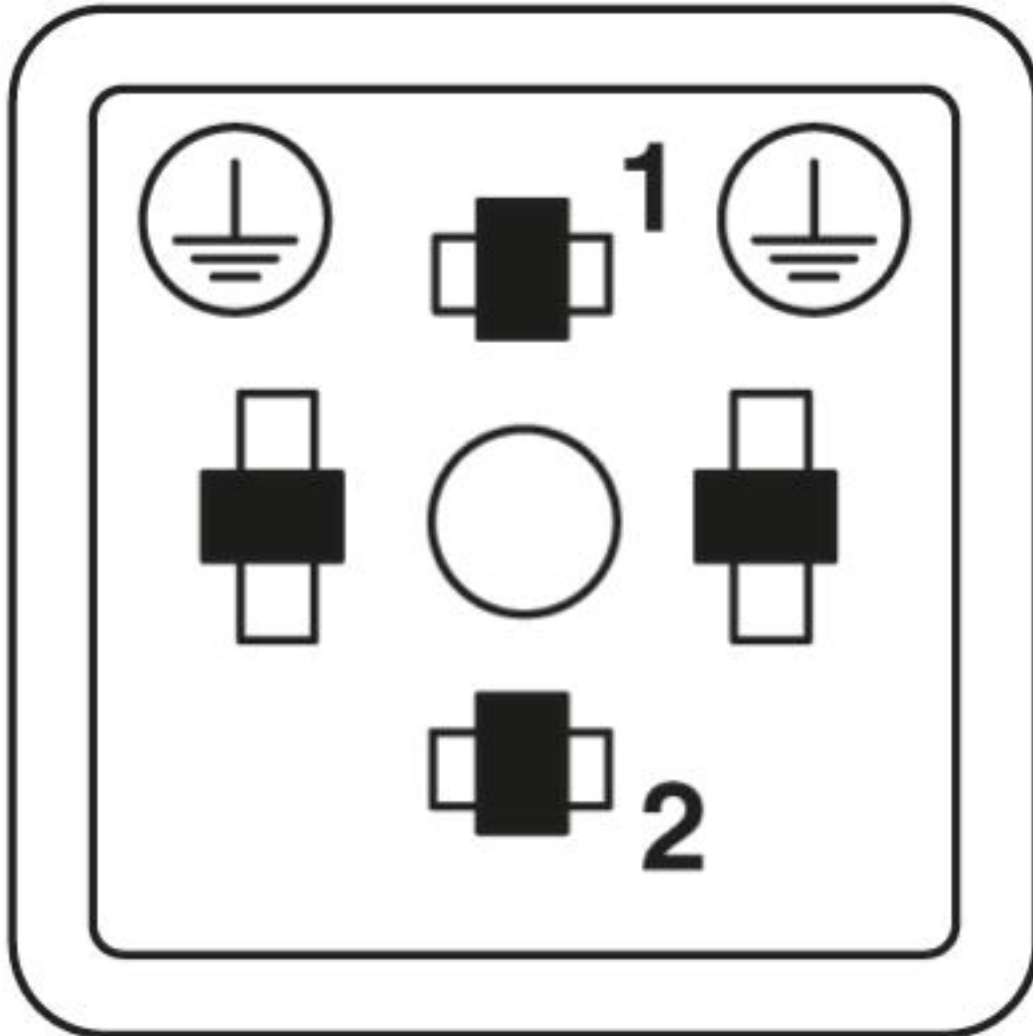

Valve connector connector pin assignment, type C

Sensor/actuator cable - SAC-3P- 5,0-PUR/C-1L-Z - 1435551

Cable cross section

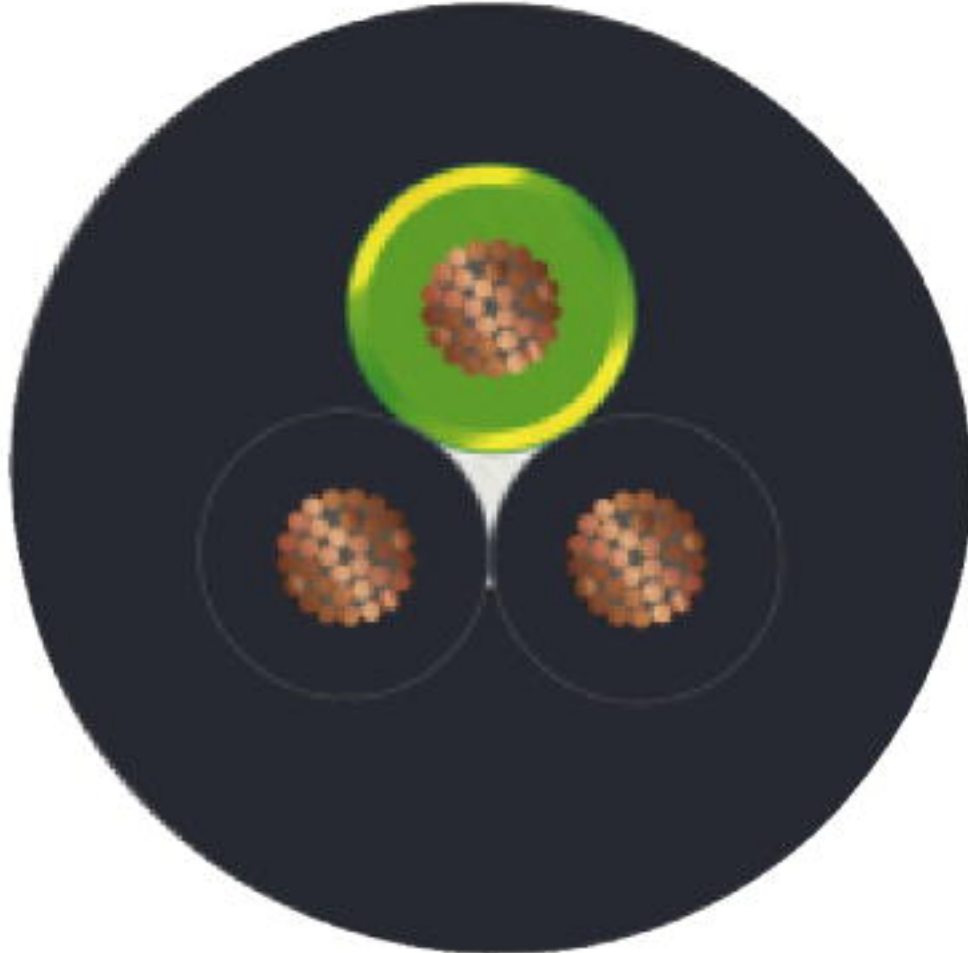

PUR halogen-free black [PUR]

Approvals

Approvals

Approvals

CSAus / EAC

Ex Approvals

Approval details

Sensor/actuator cable - SAC-3P- 5,0-PUR/C-1L-Z - 1435551

Approvals

CSAus		http://www.csagroup.org/services-industries/product-listing/	13631
Nominal voltage UN		24 V	
Nominal current IN		6 A	

EAC		RU C- DE.BL08.B.00286
-----	---	--------------------------

Phoenix Contact 2019 © - all rights reserved
<http://www.phoenixcontact.com>

PHOENIX CONTACT GmbH & Co. KG
Flachsmarktstr. 8
32825 Blomberg
Germany
Tel. +49 5235 300
Fax +49 5235 3 41200
<http://www.phoenixcontact.com>