

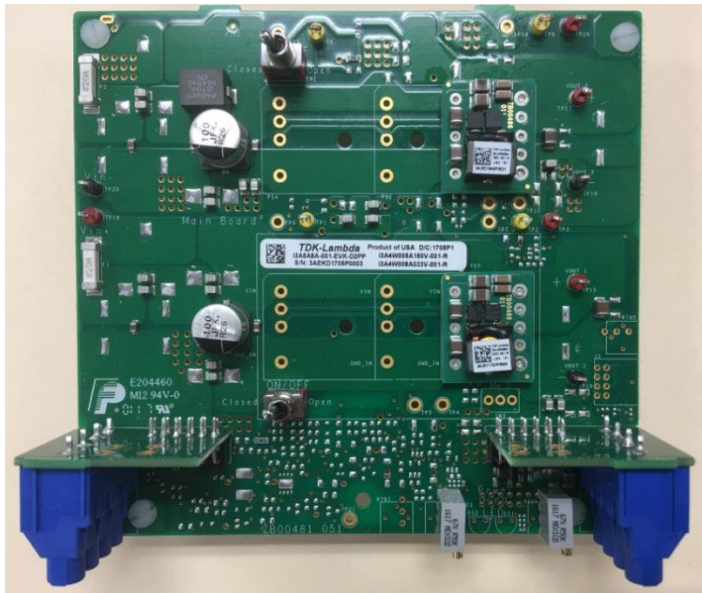

# i3A Evaluation Board Manual



TDK Lambda Evaluation Board P/N  
i3A5A8A-001-EVK-D2PP

TDK-Lambda Corporation

## **Getting Started with the i3A**

Before Using the Eval Board.....	3
Device Introduction.....	4
Evaluation Board Introduction .....	5
Converter #1 Test Points and Controls .....	6
Converter #2 Test Points and Controls.....	7
Input Section test Points.....	8
Input/Output Electrical Connections & Vo Adjust .....	9
Operation .....	10
Setup Example .....	11
Setup Example Using Scope .....	12

## **Appendices**

Scope Measurement Technique.....	13
Simplified Evaluation Board Schematic.....	15
Evaluation Board Silkscreen.....	16
Evaluation Board Bill of Materials.....	17

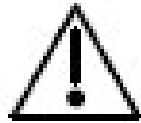

## **Caution**

- Follow the electrical connection instructions for the evaluation board carefully. Reverse Connections on the input or the output can cause permanent damage.
- Do not operate the input voltage higher than the specified values. Overvoltage on the input to the device will cause permanent damage.
- This product contains a printed circuit board utilizing surface mounted devices. PCB stresses such as bending, twisting etc. can cause damage. Please handle with care.

## Device Introduction

I3A Series DC/DC Power Modules  
**9-53V Input, 4.5 & 8A Output**  
**100W 1/32nd Brick Power Module**



I3A power modules perform local voltage conversion from a 12V, 24V, or well regulated 48V bus. The i3A series utilizes a low component count that results in both a low cost structure and a high level of performance. The open-frame, compact, design features a low profile and weight that allow for extremely flexible and robust manufacturing processes. The ultrahigh efficiency allows for a high amount of usable power even in demanding thermal environments.

## Eval Board is populated with two i3A Converters

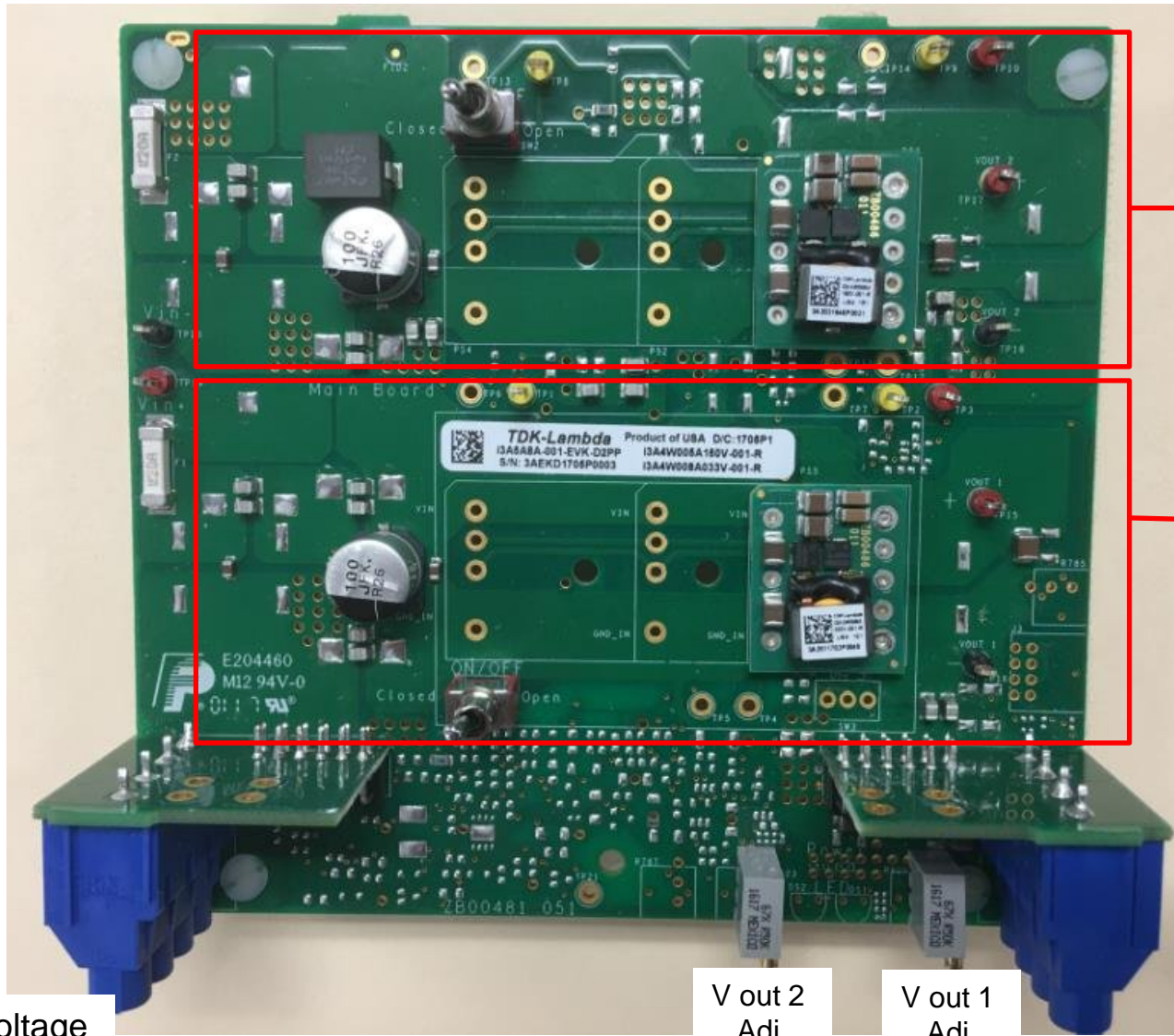

### Converter Section #2:

**I3A4W005A150V**  
 Vi: 9 – 53 VDC  
 Vo: 5 – 30 Volts  
 4.5 A Max  
 100 W Max

### Converter Section #1:

**I3A4W008A033V**  
 Vi: 9 – 53 VDC  
 Vo: 3.3 – 16.5 Volts  
 8 A Max  
 100 W Max

Input Voltage

V out 2  
Adj.

V out 1  
Adj.

Output Voltage

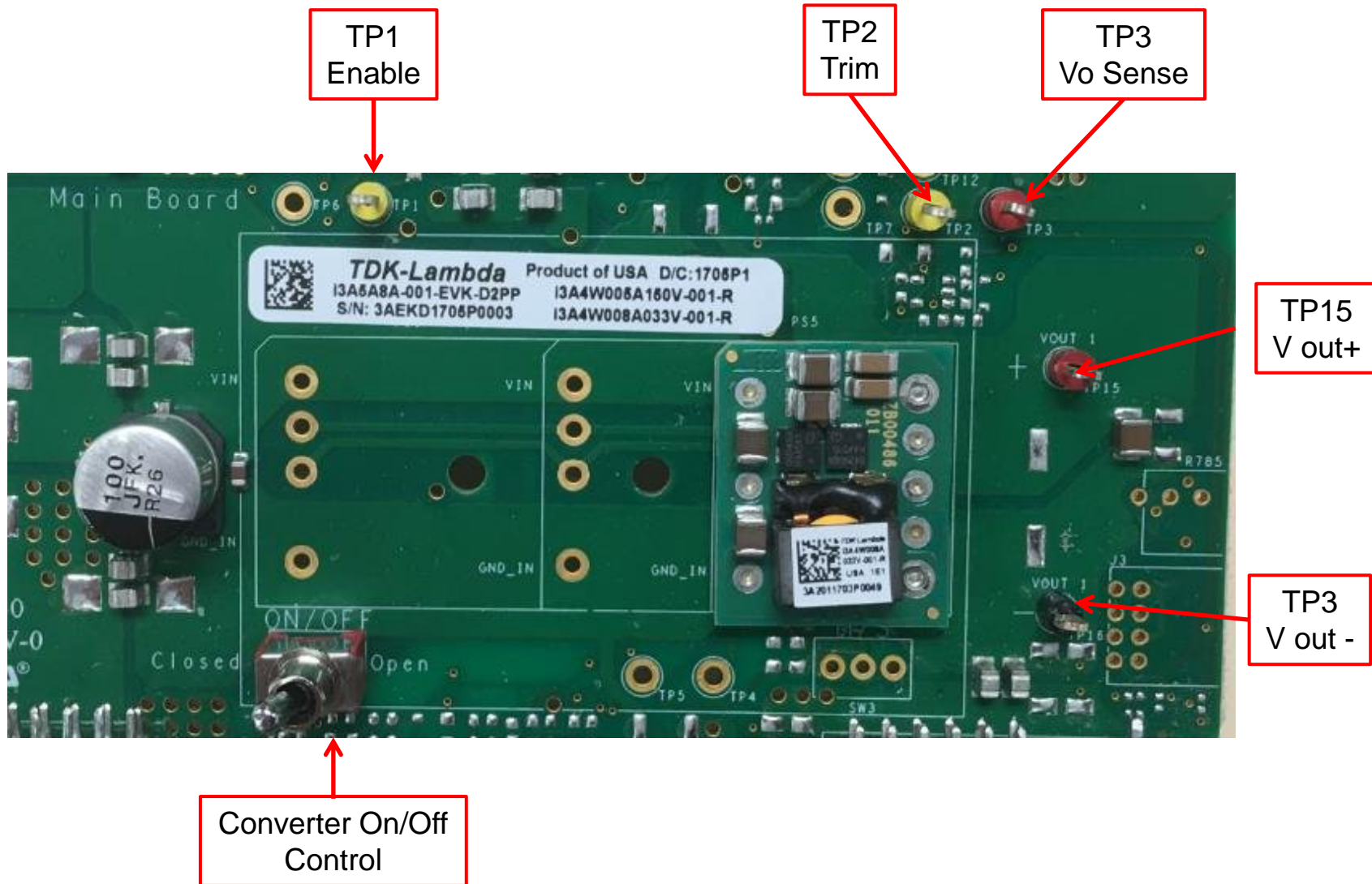

# Converter #2 Test Points and Controls

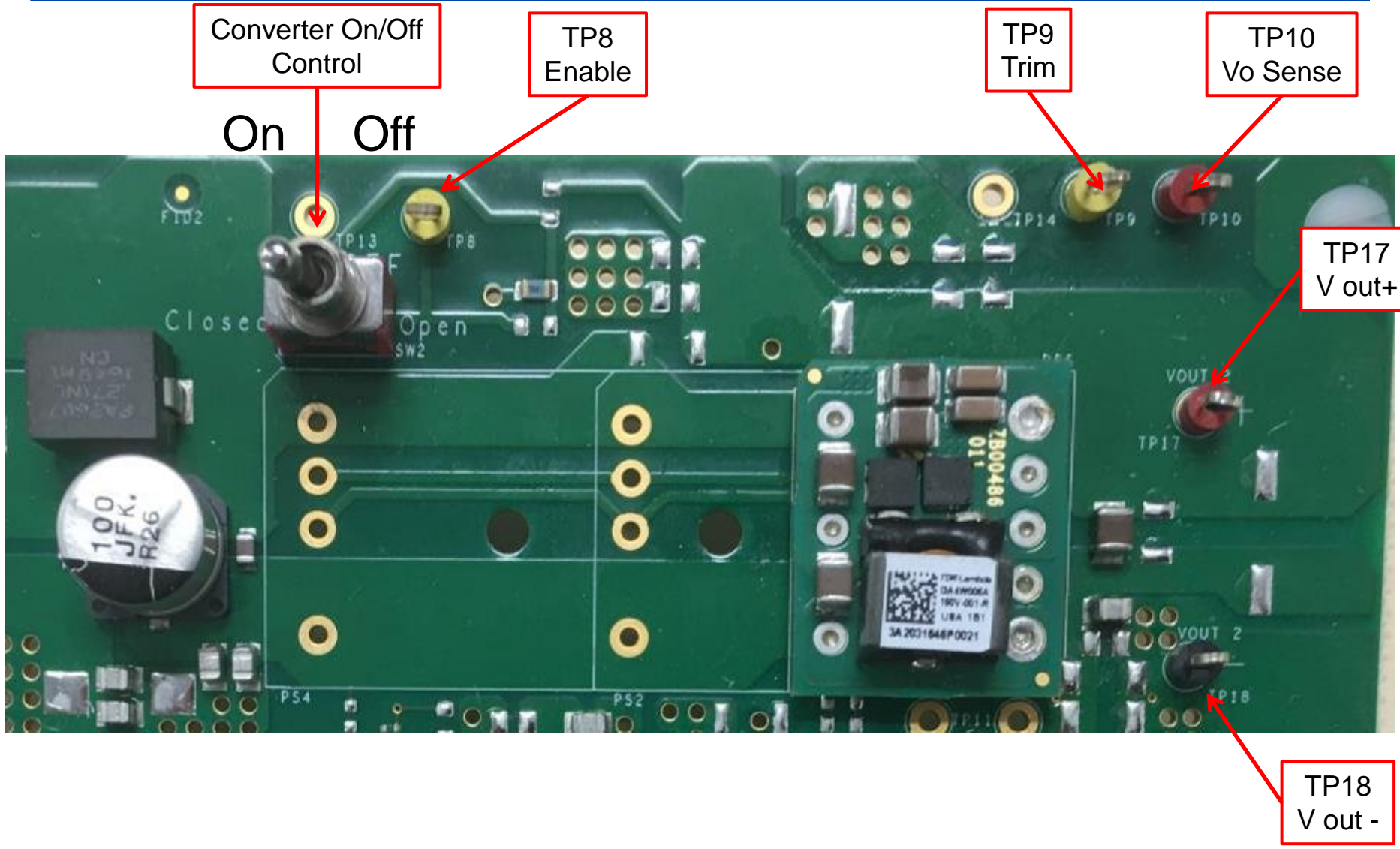

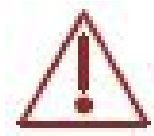

TP20  
Vin -

**Vi: 9 – 53 VDC**

TP19  
Vin +

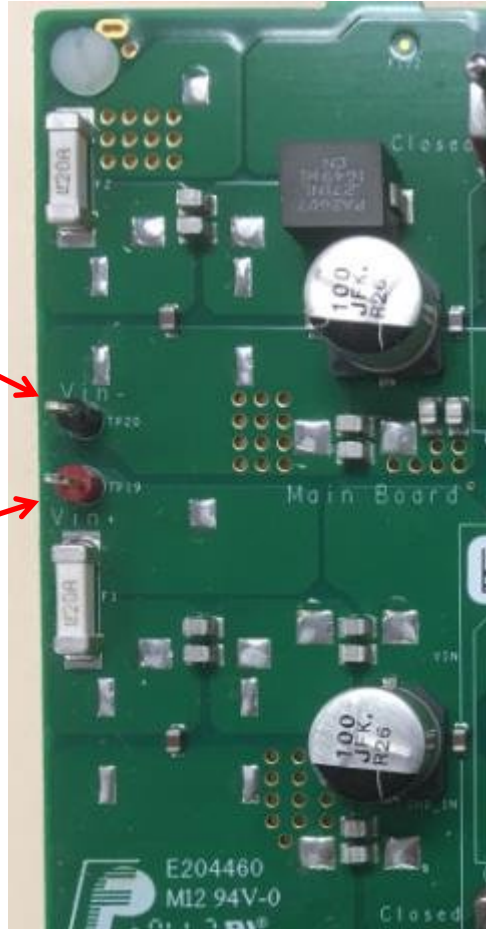

**Do not exceed input voltage range**



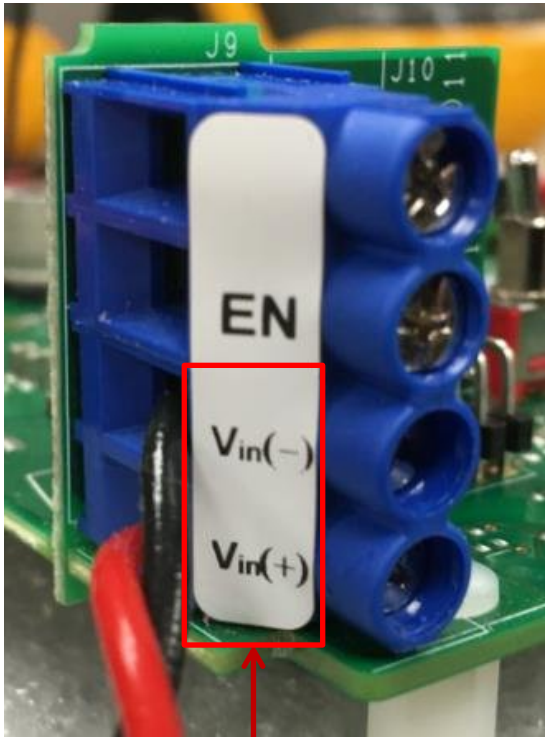

9 – 53 Volt  
Input Connections

 Do not exceed max  
input voltage

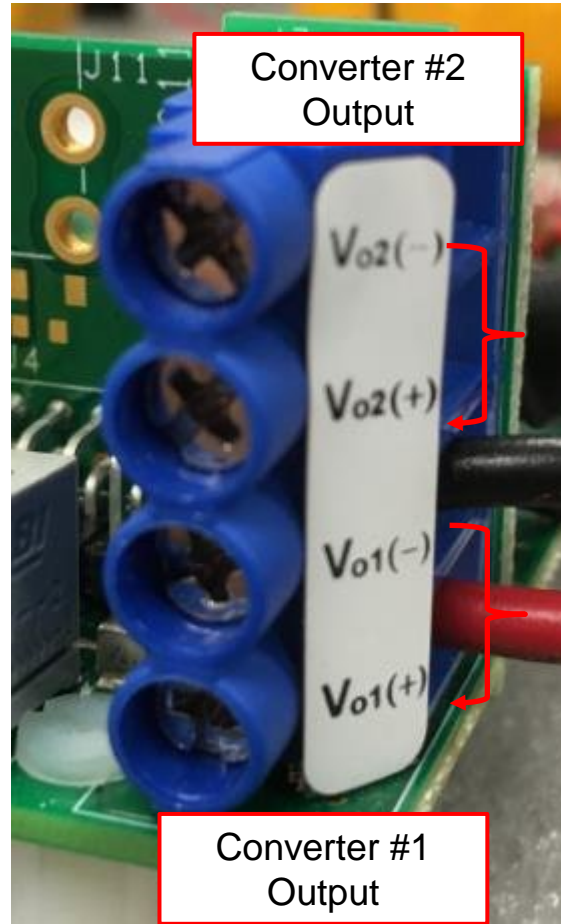

Output Connections

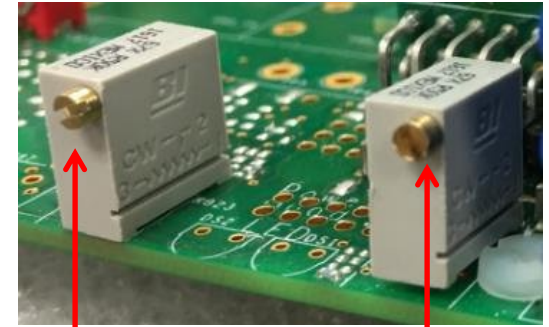

V2 Output  
Adjust

V1 Output  
Adjust

- Once input voltage is applied, either of the converters can be turned on or off using ON/OFF toggle switch.
- User can change output voltage by using Vo1 or Vo2 Trim adjust potentiometer:
  - V01 Adjustment Range: 3.3 – 16.5 Volts
  - Vo2 Adjustment Range: 5 – 30 Volts
- Please note the specified operating ranges and keep in mind that the positive output units are step down converters. The input voltage to the converters must always be greater than the output voltage. Please see charts below:

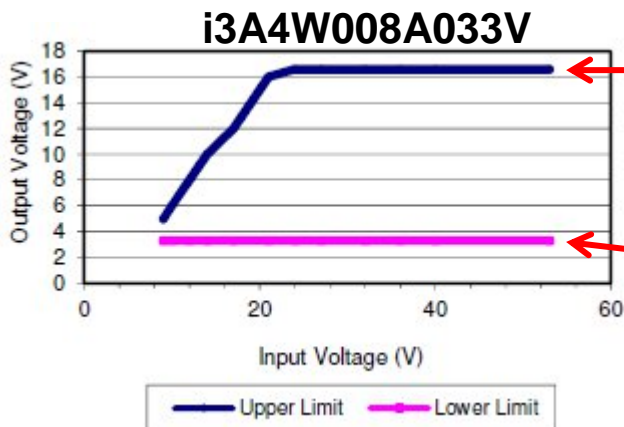

Maximum attainable output voltage for any given input voltage

Minimum attainable output voltage for any given input voltage

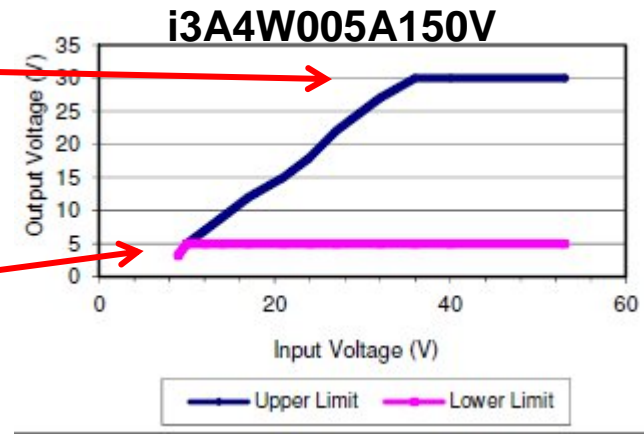

48 VDC In

Vo 2: 30  
VDC Out

Vo 1: 16.5  
VDC Out



Converters can be turned on or off using toggle switches.

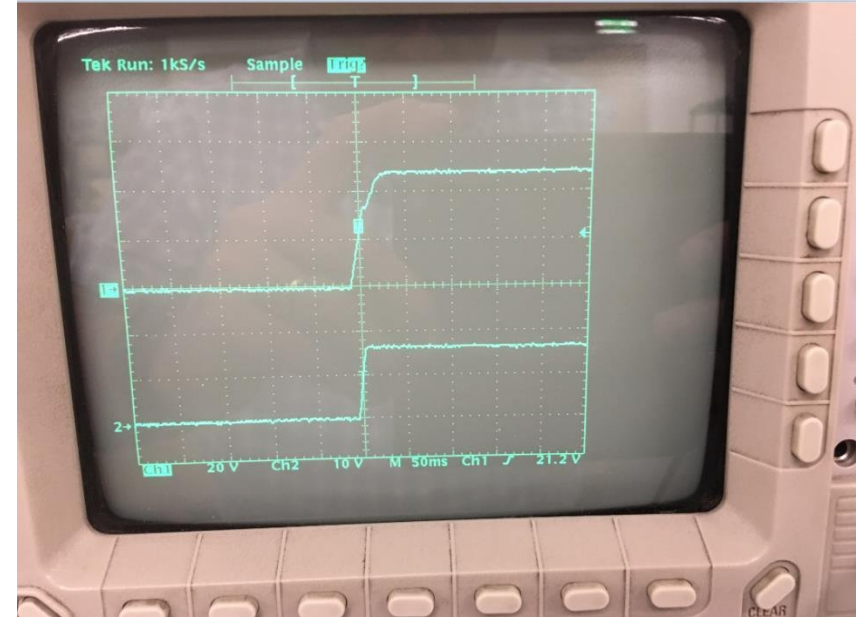

- An oscilloscope can be connected to the inputs and the outputs to observe converter behavior.
- Top trace shows input voltage rise to 48 VDC.
- Bottom Trace shows converter startup characteristic into full load.

## Scope Measurement Technique

When making sensitive measurements a vertical mini-probe socket should be used to connect the oscilloscope probe to minimize loop area of the measurement leads. See scope connection below using Agilent P/N N2768A.

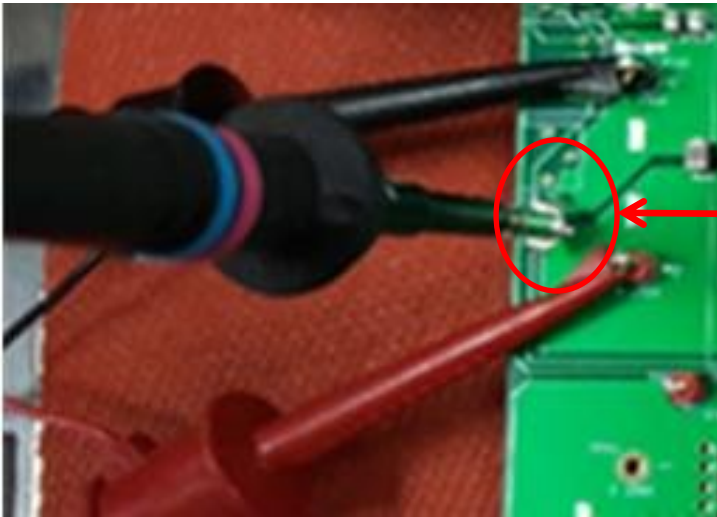

Vertical Mini Probe  
Socket P/N N2768A



## Scope Measurement Technique (cont.)

. Example below shows output ripple measurement on the left with a vertical mount socket connection to the board. The right shows loop pickup.

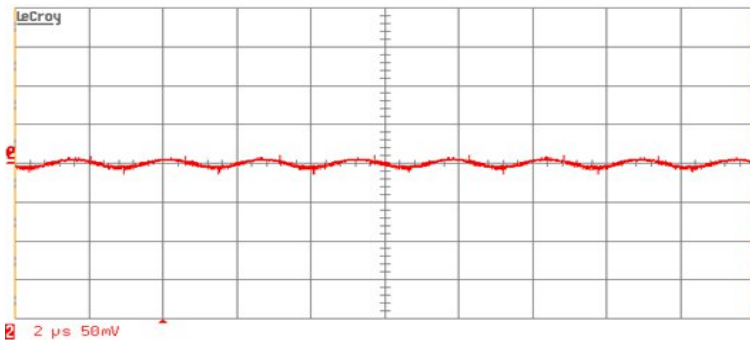
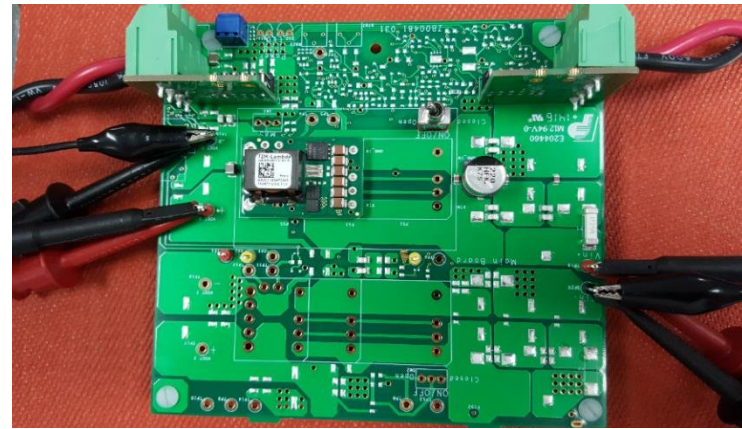

Full load output ripple with scope socket

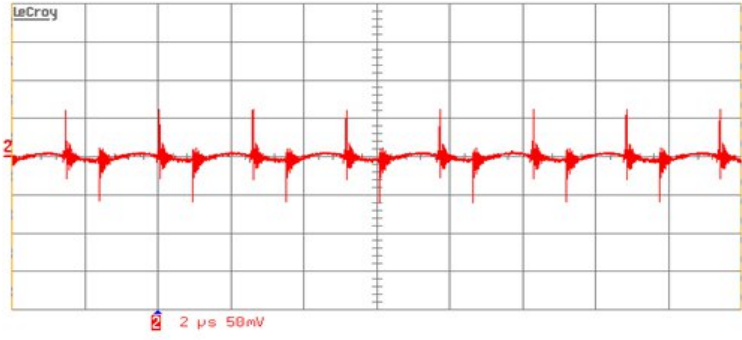

Full load output ripple with ground loop.  
Note Noise Pickup

## Simplified Evaluation Board Schematic

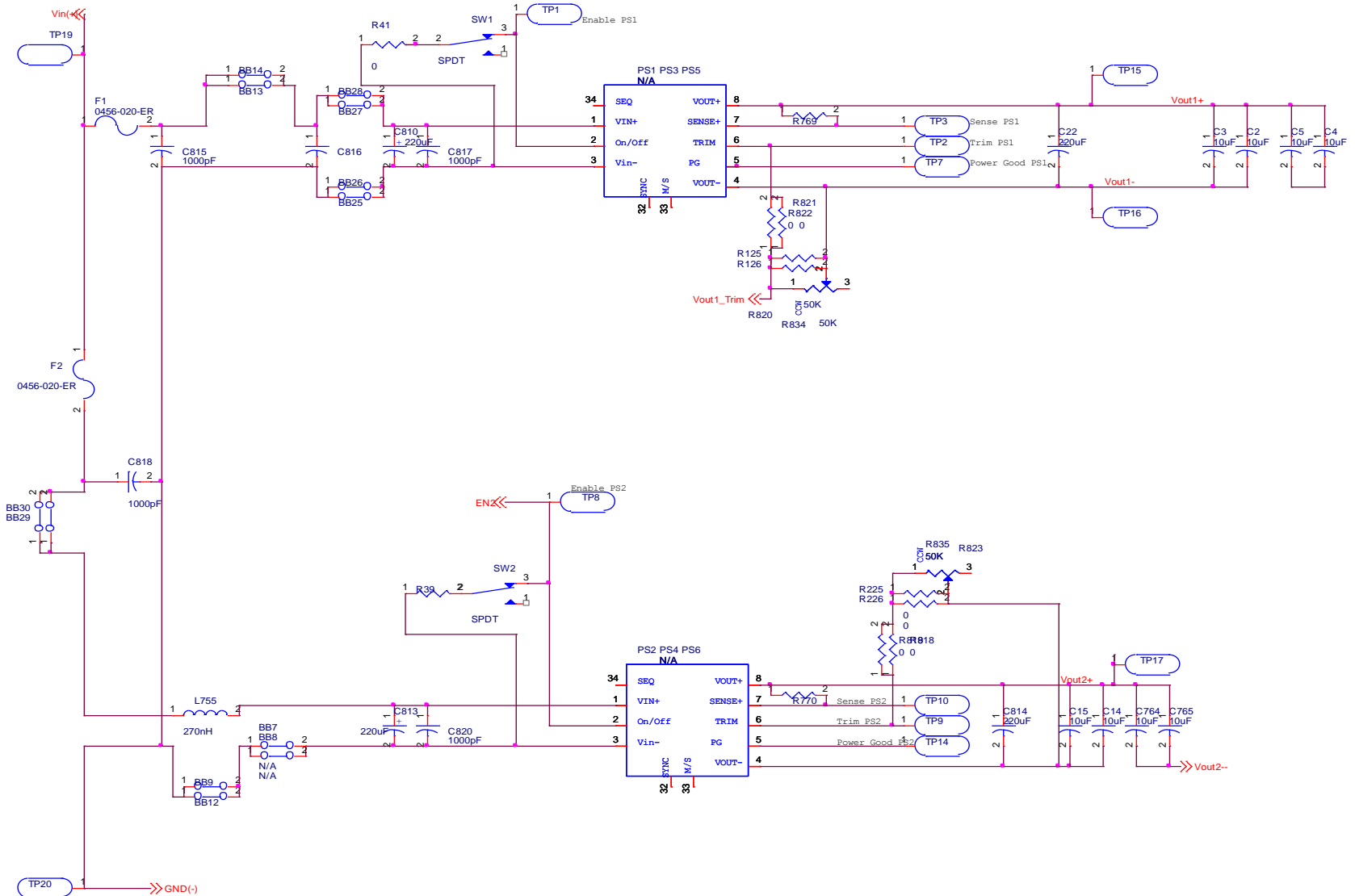

## Evaluation Board Silkscreen

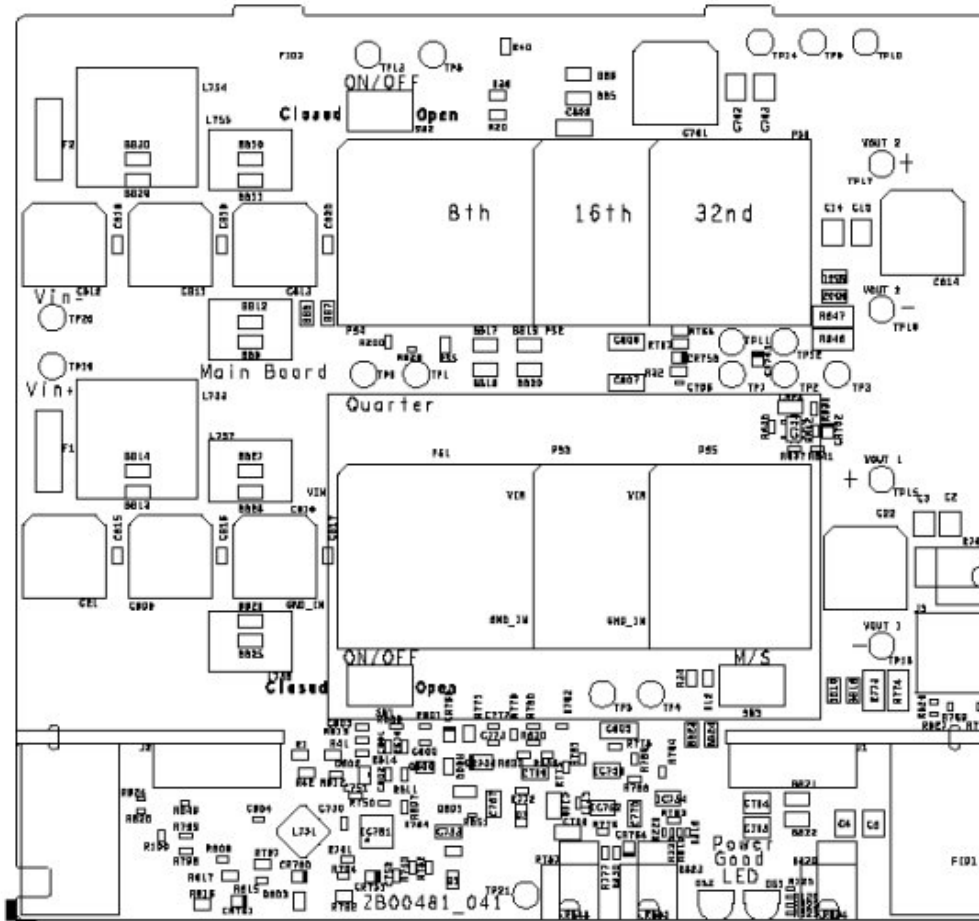



## Evaluation Board Bill Of Materials

Mfr. Name	Mfr. Part Number	Description	Ref Des
TDK	C3225X7S1H106MT	CERAMIC CAPACITOR, 50V, 1210, 10uF, X7S	C5
TDK	C3225X7S1H106MT	CERAMIC CAPACITOR, 50V, 1210, 10uF, X7S	C3
TDK	C3225X7S1H106MT	CERAMIC CAPACITOR, 50V, 1210, 10uF, X7S	C14
TDK	C3225X7S1H106MT	CERAMIC CAPACITOR, 50V, 1210, 10uF, X7S	C764
PANASONIC	EEEFK1J101P	CAP, 100UF, 63V, SMT	C810
PANASONIC	EEEFK1J101P	CAP, 100UF, 63V, SMT	C813
TDK	C2012X7S2A105K125AB	CERAMIC CAPACITOR, 100V, 0805, 1.0uF	C820
TDK	C2012X7S2A105K125AB	CERAMIC CAPACITOR, 100V, 0805, 1.0uF	C815
TDK	C2012X7S2A105K125AB	CERAMIC CAPACITOR, 100V, 0805, 1.0uF	C817
TDK	C2012X7S2A105K125AB	CERAMIC CAPACITOR, 100V, 0805, 1.0uF	C816
TDK	C2012X7S2A105K125AB	CERAMIC CAPACITOR, 100V, 0805, 1.0uF	C818
TDK	C2012X7S2A105K125AB	CERAMIC CAPACITOR, 100V, 0805, 1.0uF	C819
PULSE	PA2607.271NL	270nH 30A	L755
LITTLEFUSE	0456020.ER	20A SMT Fuse	F1
LITTLEFUSE	0456020.ER	20A SMT Fuse	F2
Power Unit Assembly	I3A4W008A033V-001-R	DCDC Power Module	PS5
Power Unit Assembly	I3A4W005A150V-001-R	DCDC Power Module	PS6