

## MAX20313–MAX20316

## 500mA to 6A Adjustable Current-Limit Switches

### General Description

The MAX20313–MAX20316 programmable current-limit switches feature internal current limiting to prevent damage to host devices due to faulty load conditions. These current-limit switches feature a low, 10m $\Omega$  (typ) on-resistance and operate from a +2.5V to +5.5V input voltage range. The current limit is adjustable from 500mA to 6A, making these devices ideal for charging a large load capacitor and for high-current load-switching applications.

The MAX20313 and MAX20315 feature a continuous current-limit mode during an overcurrent event. The MAX20314 and MAX20316 feature a latching mode during an overcurrent event. Additional safety features include thermal shutdown protection to prevent overheating and reverse current blocking to prevent current from being driven back into the source.

The devices are available in a 12-bump (0.4mm pitch, 1.68mm x 1.48mm) wafer-level package (WLP) and operate over the -40°C to +85°C extended temperature range.

### Benefits and Features

- Reliable Protection
  - Adjustable Current Limit (500mA to 6A)
  - Accurate  $\pm 5\%$  Overload Current Limit (2A to 6A)
  - Current Monitoring
  - Low  $R_{ON}$  10m $\Omega$  (typ)
  - Reverse Current Protection
  - Short-Circuit Protection
  - Thermal Shutdown Protection
- Space Saving
  - 12-Bump 0.4mm Pitch 1.68mm x 1.48mm WLP

### Applications

- RF Power Amplifiers in Cell Phones
- USB Ports
- Data Modem Cards
- Portable Media Players
- UTCA/ATCA Platforms
- SDXC Card Power Supply Protection

**Ordering Information** appears at end of data sheet.

### Absolute Maximum Ratings

(All voltages referenced to GND.)

IN, OUT, EN, EN, FLAG, SET1.....-0.3V to +6V  
 Continuous Current Into Any Terminal (except IN, OUT)...20mA  
 OUT Short Circuit to GND.....Internally Limited  
 Continuous Power Dissipation (T<sub>A</sub> = +70°C)  
 WLP (derate 13.73mW/°C above +70°C)..... 1098.4mW

Operating Temperature Range..... -40°C to +85°C  
 Junction Temperature..... +150°C  
 Storage Temperature Range..... -65°C to +150°C  
 Soldering Temperature (reflow)..... +260°C

*Stresses beyond those listed under "Absolute Maximum Ratings" may cause permanent damage to the device. These are stress ratings only, and functional operation of the device at these or any other conditions beyond those indicated in the operational sections of the specifications is not implied. Exposure to absolute maximum rating conditions for extended periods may affect device reliability.*

### Package Information

<b>PACKAGE TYPE: 12 WLP</b>	
Package Code	W121K1+1
Outline Number	21-100118
Land Pattern Number	Refer to <a href="#">Application Note 1891</a>
<b>THERMAL RESISTANCE, FOUR-LAYER BOARD</b>	
Junction to Ambient (θ <sub>JA</sub> )	72.82°C/W

For the latest package outline information and land patterns (footprints), go to [www.maximintegrated.com/packages](http://www.maximintegrated.com/packages). Note that a "+", "#", or "-" in the package code indicates RoHS status only. Package drawings may show a different suffix character, but the drawing pertains to the package regardless of RoHS status.

Package thermal resistances were obtained using the method described in JEDEC specification JESD51-7, using a four-layer board. For detailed information on package thermal considerations, refer to [www.maximintegrated.com/thermal-tutorial](http://www.maximintegrated.com/thermal-tutorial).

### Electrical Characteristics

(V<sub>IN</sub> = 2.5V to 5.5V, T<sub>A</sub> = -40°C to +85°C, unless otherwise noted. Typical values are at V<sub>IN</sub> = 4.3V, C<sub>IN</sub> = 1µF, C<sub>OUT</sub> = 1µF, T<sub>A</sub> = +25°C) (Note 1)

PARAMETER	SYMBOL	CONDITIONS	MIN	TYP	MAX	UNITS
<b>SUPPLY OPERATION</b>						
Operating Voltage	V <sub>IN</sub>		2.5		5.5	V
Undervoltage Lockout	V <sub>UVLO</sub>			1.45		V
Quiescent Current	I <sub>Q</sub>	I <sub>OUT</sub> = 0A, switch on, (supply current comes from high voltage between IN and OUT)		250	525	µA
Latchoff Current	I <sub>LATCH</sub>	V <sub>IN</sub> = 4.3V, I <sub>OUT</sub> = 0A, after an overcurrent fault (MAX20314, MAX20316)		3.5	20	µA
Shutdown Forward Current	I <sub>SHDN</sub>	V <sub>EN</sub> = 0V, V <sub>EN</sub> = V <sub>IN</sub> , V <sub>IN</sub> = 5.5V, V <sub>OUT</sub> = 0V		3.0	20	µA
Shutdown Reverse Current	I <sub>RSHDN</sub>	V <sub>EN</sub> = 0V, V <sub>EN</sub> = V <sub>OUT</sub> , V <sub>IN</sub> = 0V, V <sub>OUT</sub> = 5.5V		3.0	20	µA
<b>INTERNAL FET</b>						
Switch-on Resistance (Note 2)	R <sub>ON</sub>	V <sub>IN</sub> = 4.3V, I <sub>OUT</sub> = 1A, I <sub>OUT</sub> < I <sub>LIM</sub> , T <sub>A</sub> = +25°C		10	19	mΩ
Forward Current Limit (Note 2)	I <sub>LIM</sub>	R <sub>SET1</sub> = 680Ω, V <sub>IN</sub> = 4.3V	5700	6000	6300	mA
		R <sub>SET1</sub> = 2050Ω, V <sub>IN</sub> = 4.3V	1900	2000	2100	
		R <sub>SET1</sub> = 8350Ω, V <sub>IN</sub> = 4.3V	425	500	575	

**Electrical Characteristics (continued)**

( $V_{IN} = 2.5V$  to  $5.5V$ ,  $T_A = -40^{\circ}C$  to  $+85^{\circ}C$ , unless otherwise noted. Typical values are at  $V_{IN} = 4.3V$ ,  $C_{IN} = 1\mu F$ ,  $C_{OUT} = 1\mu F$ ,  $T_A = +25^{\circ}C$ ) (Note 1)

PARAMETER	SYMBOL	CONDITIONS	MIN	TYP	MAX	UNITS
Current Limit Fold Back	$I_{LIM\_FB}$	$V_{IN} = 4.3V$ , $V_{OUT} = 0V$ , $I_{LIM} = 1A$		-10		%
$R_{SETI}$ Coefficient	P	$I_{LIM} = 500mA$ to $6A$		3329		
$R_{SETI}$ Constant	C	$I_{LIM} = 500mA$ to $6A$		12		mA
Load Transient Step Reaction Time	$t_{SR}$	$V_{IN} = V_{EN} = 4.3V$ , $I_{LOAD} = 80\% I_{LIM}$ steps to $120\% I_{LIM}$ to flowing current within $10\% I_{LIM}$		60		$\mu s$
Accurate Reverse Current Blocking Trigger Threshold	$V_{AREV\_TH}$	$V_{OUT} - V_{IN}$	1	8	25	mV
Accurate Reverse Current Blocking Release Threshold	$V_{AREV\_EX}$	$V_{OUT} - V_{IN}$	0	7		mV
Accurate Reverse Blocking Debounce Time	$t_{DB\_ARIB}$	( $V_{OUT} - V_{IN}$ ) changes from $0V$ to $-0.02V$ in $100ns$ , the time needed to block reverse current		128		$\mu s$
Fast Reverse Current Blocking Threshold	$V_{FREV\_TH}$	$V_{OUT} - V_{IN}$	40	65	110	mV
Fast Reverse Blocking Response Time	$t_{FRIB}$	( $V_{OUT} - V_{IN}$ ) changes from $0V$ to $-0.3V$ in $100ns$ , the time needed to block reverse current		3		$\mu s$
$\overline{FLAG}$ Assertion Drop Voltage Threshold	$V_{FA}$	Increase ( $V_{IN} - V_{OUT}$ ) drop until $\overline{FLAG}$ asserts, in current limit mode, $V_{IN} = 4.3V$	70	120	185	mV
<b>EN, <math>\overline{EN}</math> INPUT</b>						
EN, $\overline{EN}$ Input Leakage	$I_{LEAK}$	EN, $\overline{EN} = IN$ or GND	-0.9		0.9	$\mu A$
EN, $\overline{EN}$ Input Logic-High Voltage	$V_{IH}$		1.4			V
EN, $\overline{EN}$ Input Logic-Low Voltage	$V_{IL}$				0.4	V
<b>FLAG OUTPUT</b>						
$\overline{FLAG}$ Output Logic-Low Voltage		$I_{SINK} = 1mA$			0.4	V
$\overline{FLAG}$ Output Leakage Current		$V_{IN} = V_{FLAG} = 5.5V$ , $\overline{FLAG}$ deasserted			0.9	$\mu A$
<b>TIMING CHARACTERISTICS</b>						
Turn-On Delay	$t_{ON}$	Time from EN/ $\overline{EN}$ signal to $V_{OUT} = 90\%$ of $V_{IN}$ , $V_{IN} = 4.3V$ (Figure 1)	2.5	4	5	ms
Turn-Off Time	$t_{OFF}$	Time from EN/ $\overline{EN}$ signal to $V_{OUT} = 10\%$ of $V_{IN}$ , $V_{IN} = 4.3V$ , $C_{LOAD} = 1000pF$ , $R_{LOAD} = 860\Omega$ (Figure 1)		50		$\mu s$
Current-Limit Reaction Time	$t_{LIM}$	$V_{IN} = 4.3V$ , output high and then short circuit applied, $I_{OUT} > 200\% I_{LIM}$		3		$\mu s$
Blanking Time	$t_{BLANK}$	$V_{IN} = 4.3V$ (Figure 2)	12	15	18	ms
<b>THERMAL PROTECTION</b>						
Thermal Shutdown				150		$^{\circ}C$
Thermal Shutdown Hysteresis				20		$^{\circ}C$
Temperature Increase Self-Limitation				130		$^{\circ}C$

**Note 1:** All devices are 100% production tested at  $T_A = +25^{\circ}C$ . Specifications over the operating temperature range are guaranteed by design.

**Note 2:** Guaranteed by design and device characterization.

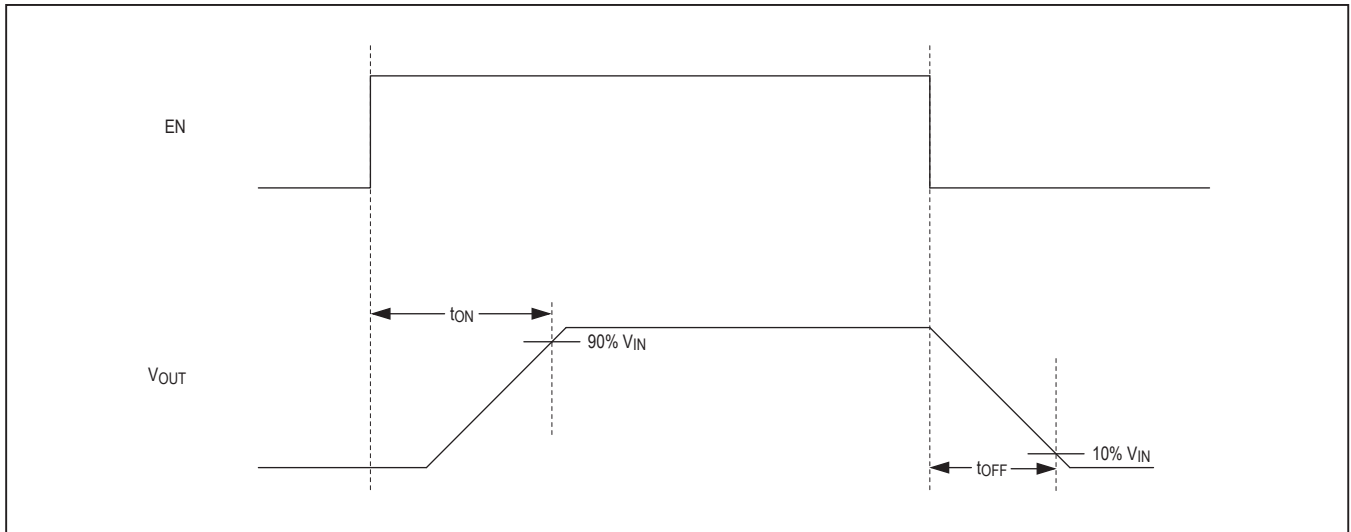

Figure 1. Timing Diagram for Measuring Turn-On Time and Turn-Off Time

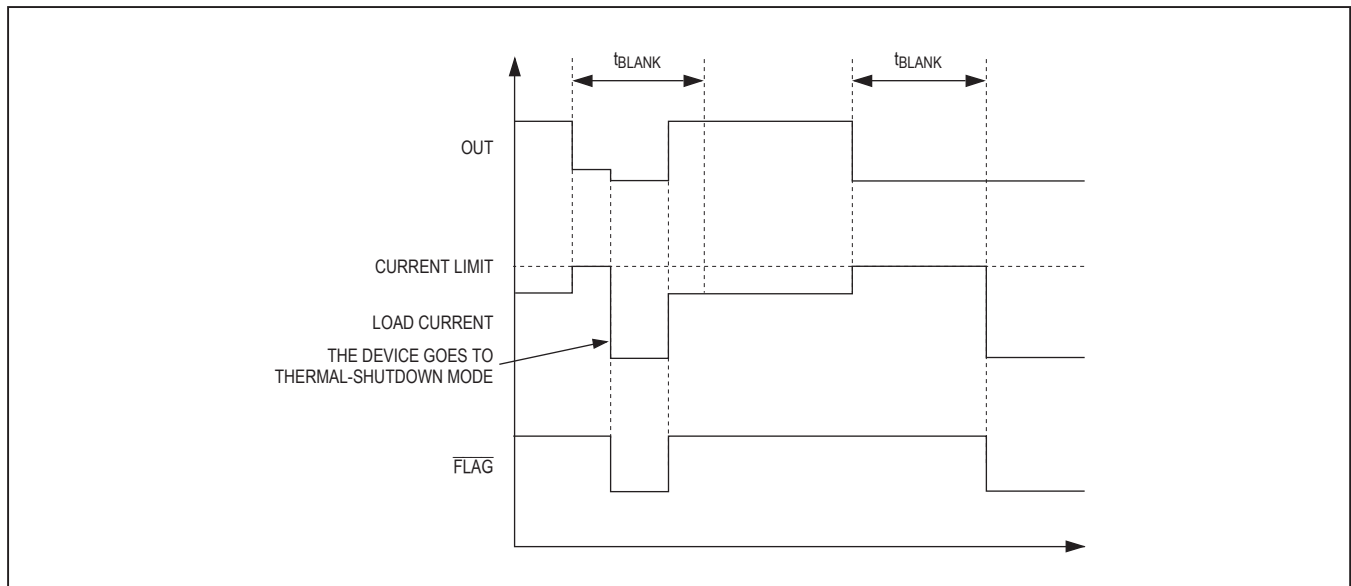
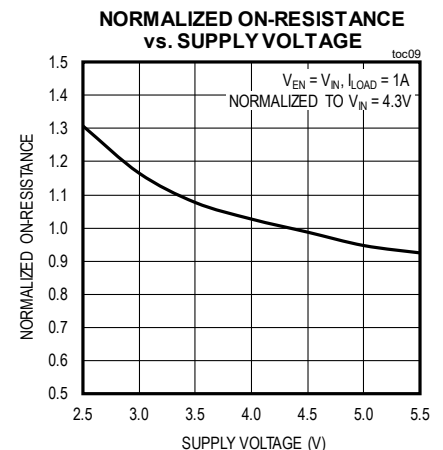
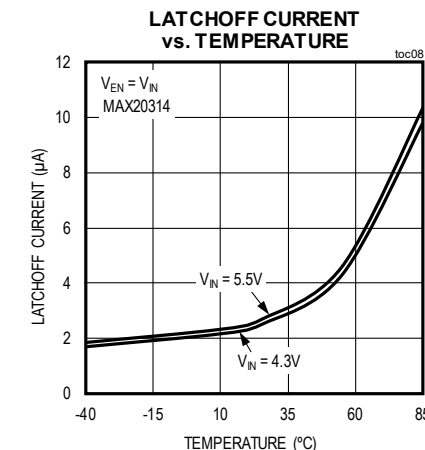
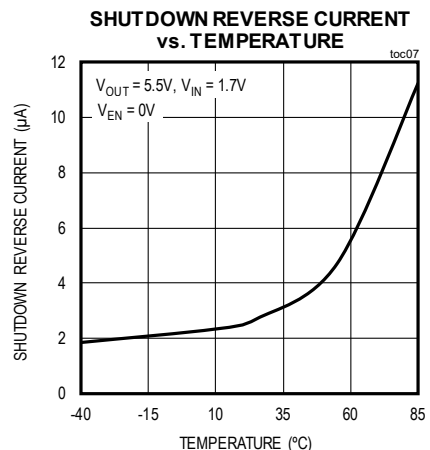
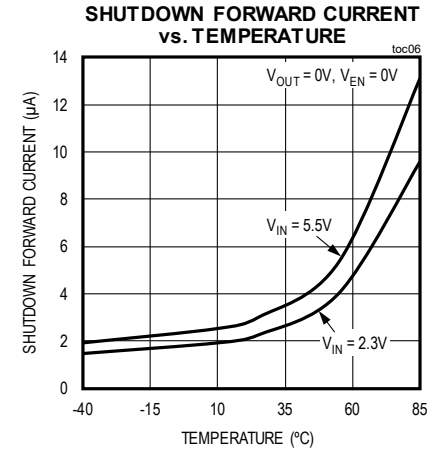
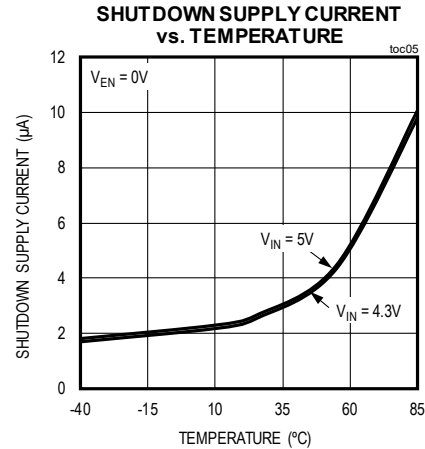
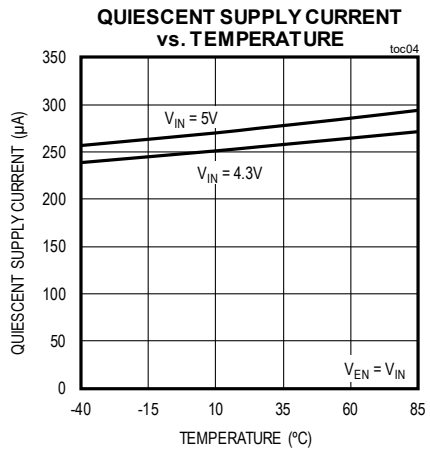
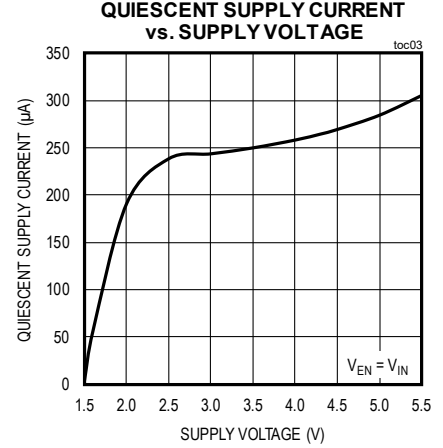
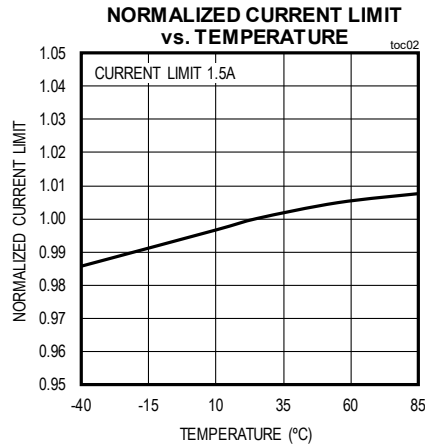
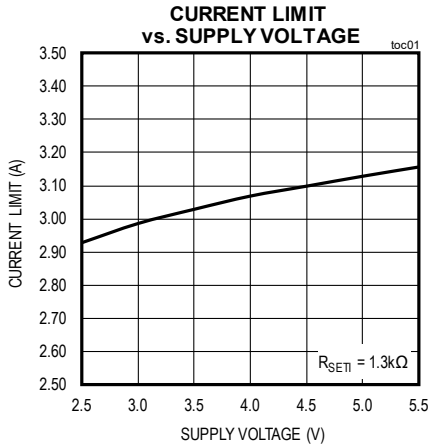

Figure 2. Latchoff Fault Diagram

Typical Operating Characteristics

( $V_{IN} = 4.3V$ ,  $C_{IN} = 1\mu F$ ,  $C_{OUT} = 1\mu F$ ,  $T_A = +25^\circ C$ , unless otherwise noted.)



Typical Operating Characteristics (continued)

( $V_{IN} = 4.3V$ ,  $C_{IN} = 1\mu F$ ,  $C_{OUT} = 1\mu F$ ,  $T_A = +25^\circ C$ , unless otherwise noted.)

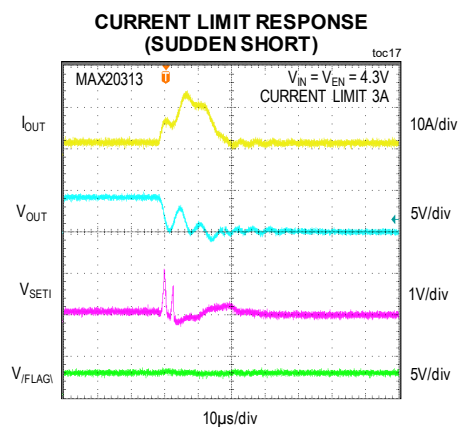
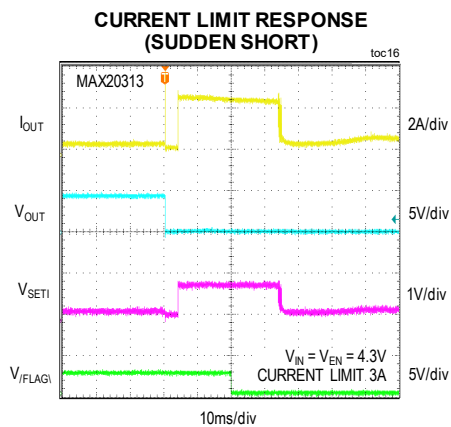
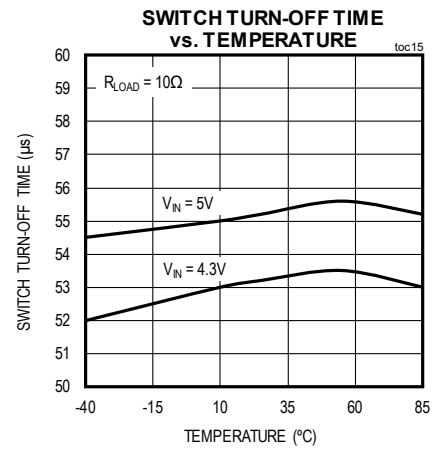
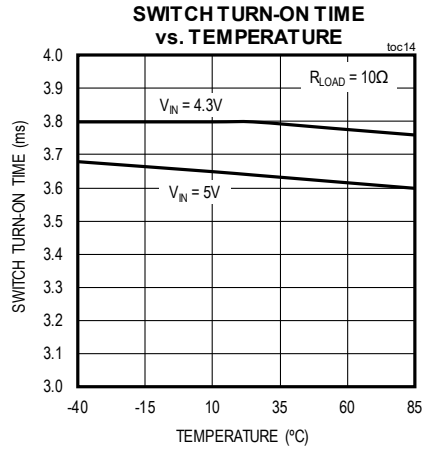
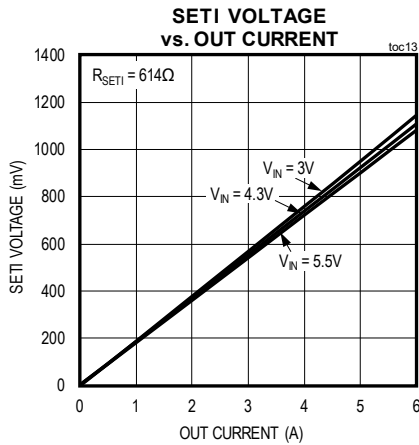
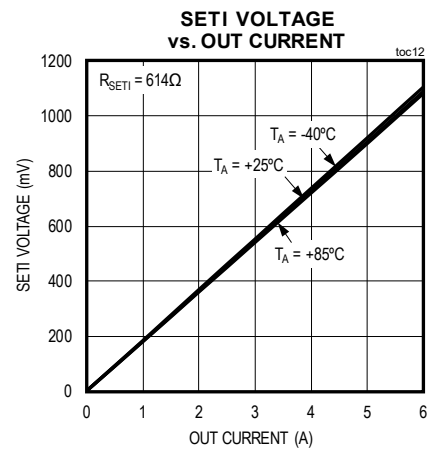
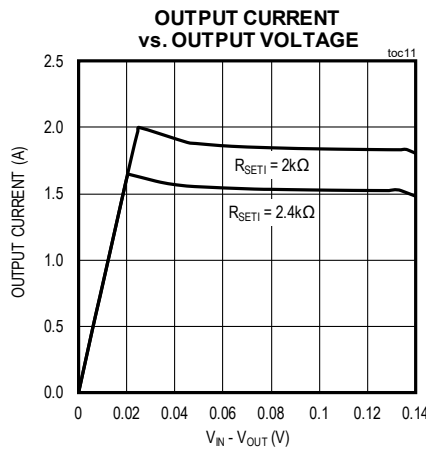
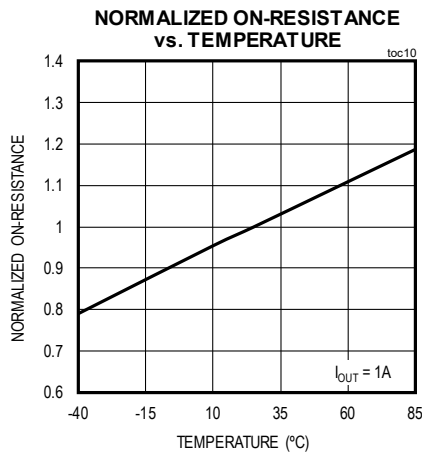

**Typical Operating Characteristics (continued)**

( $V_{IN} = 4.3V$ ,  $C_{IN} = 1\mu F$ ,  $C_{OUT} = 1\mu F$ ,  $T_A = +25^\circ C$ , unless otherwise noted.)

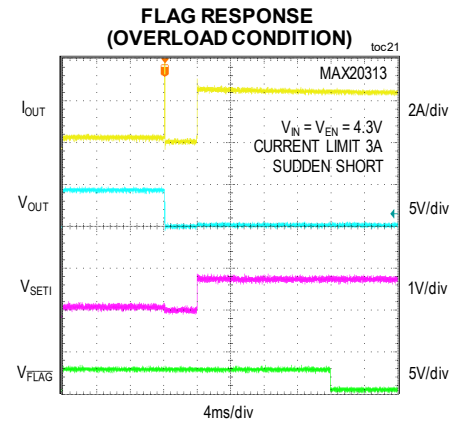
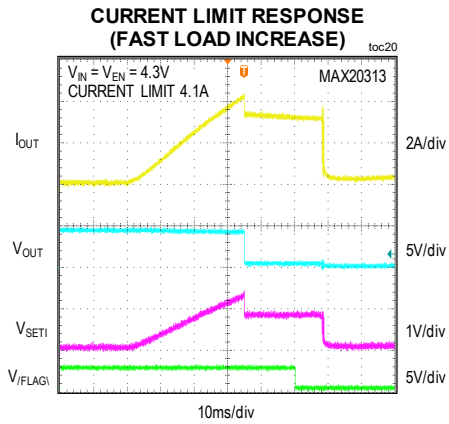
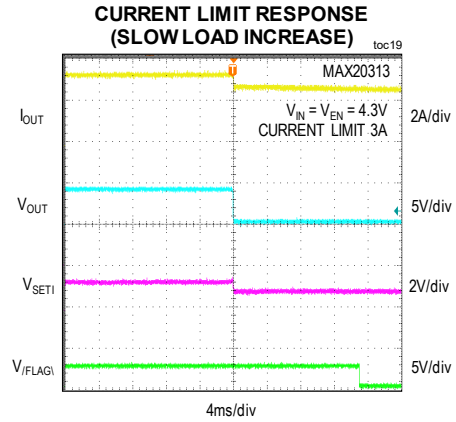
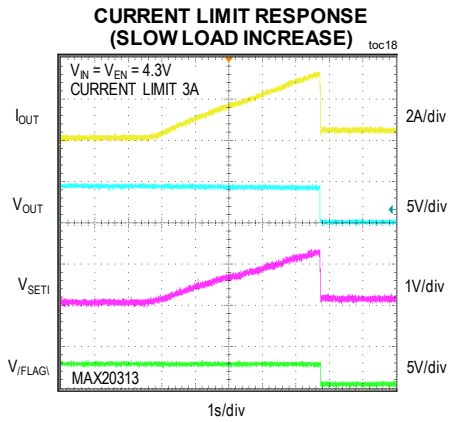

### Bump Configurations

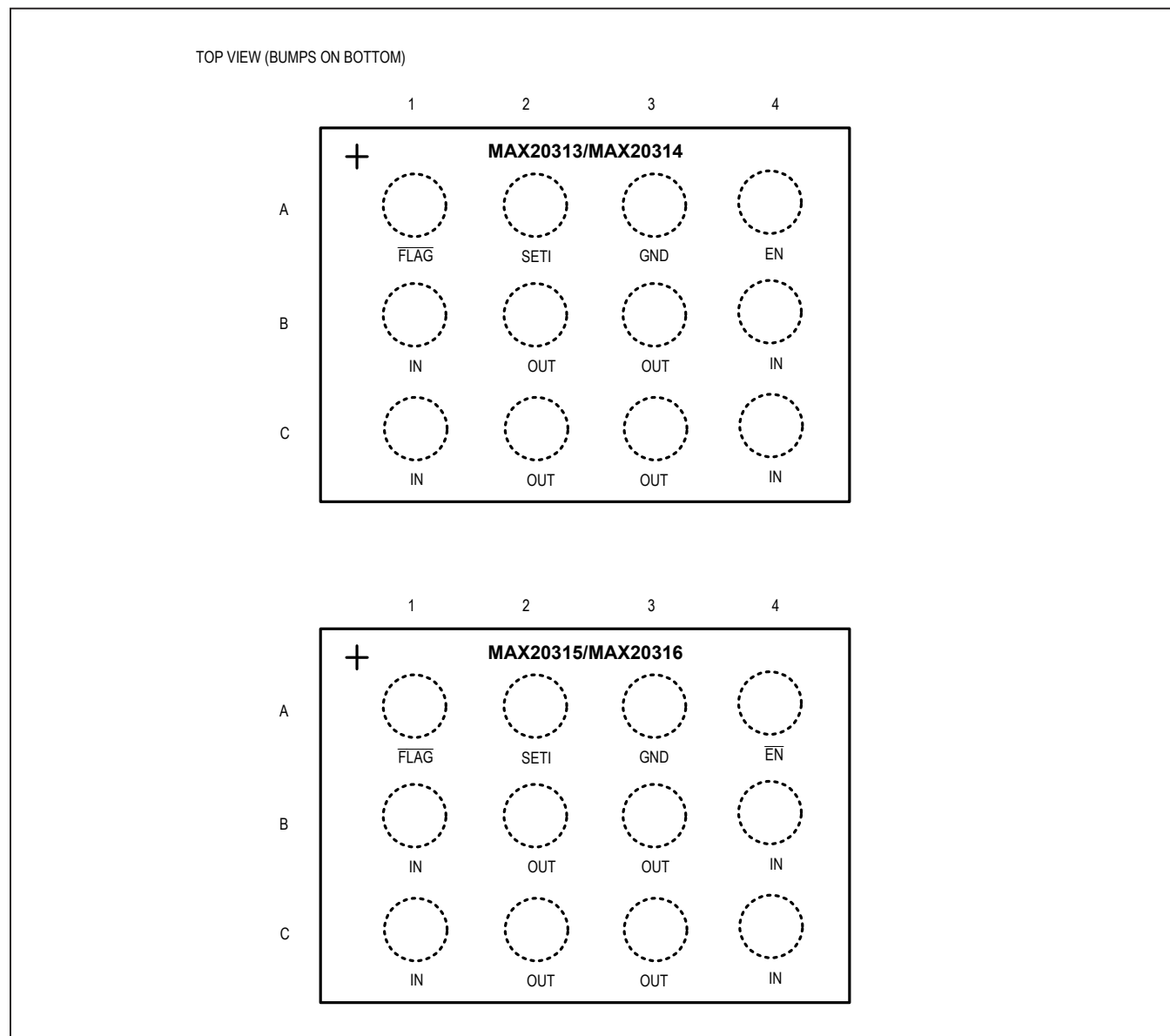



## Bump Description

BUMP		NAME	FUNCTION
MAX20313 MAX20314	MAX20315 MAX20316		
A1	A1	$\overline{\text{FLAG}}$	Open-Drain Overcurrent Indicator Output. $\overline{\text{FLAG}}$ goes low when the overload fault duration exceeds the blanking time, reverse current is detected, or thermal shutdown mode is active.
A2	A2	SETI	Forward Current-Limit Adjust Input. Connect a resistor from SETI to GND to program the overcurrent limit. If SETI is connected to GND, the device, as well as the connected circuitry, cannot be protected from an overcurrent condition. Leaving SETI unconnected forces the device to set an arbitrary small but uncontrolled current limitation (<100mA).
A3	A3	GND	Ground
A4	—	EN	Active-High Enable Input. Drive EN high to turn on the switch. Drive EN low to turn off the switch.
—	A4	$\overline{\text{EN}}$	Active-Low Enable Input. Drive $\overline{\text{EN}}$ low to turn on the switch. Drive $\overline{\text{EN}}$ high to turn off the switch.
B1, B4, C1, C4	B1, B4, C1, C4	IN	Power Input. Connect IN together and bypass IN to GND with a 1 $\mu$ F ceramic capacitor as close as possible to the device. If necessary, use higher capacitance to prevent large load transients from pulling down the supply voltage.
B2, B3, C2, C3	B2, B3, C2, C3	OUT	Switch Output. Connect OUT together and bypass OUT to GND with a 1 $\mu$ F ceramic capacitor as close as possible to the device.

Functional Diagram

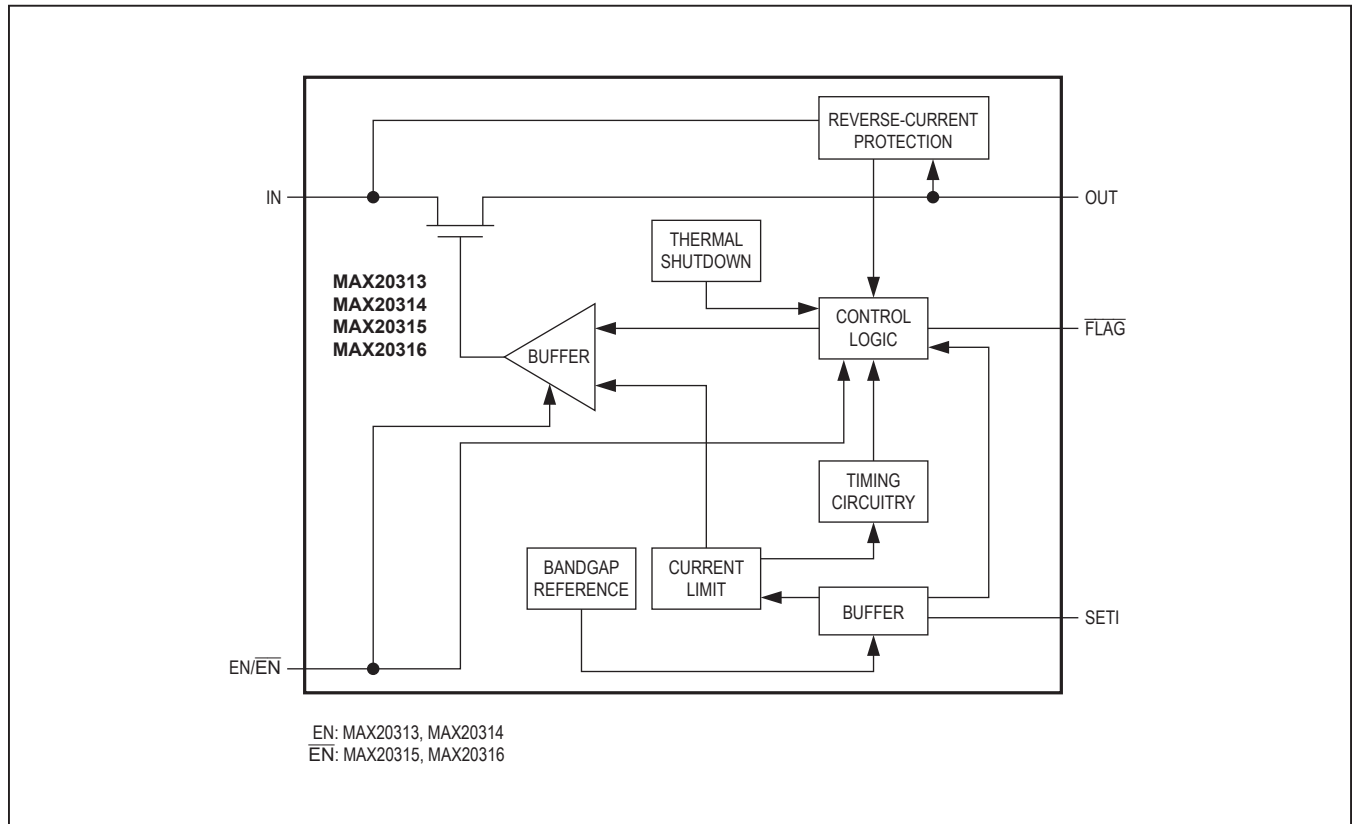

Detailed Description

The MAX20313-MAX20316 programmable current-limit switches operate from +2.5V to +5.5V and provide internal current-limiting adjustable from 500mA to 6A. These devices feature a fixed blanking time and a FLAG output that notifies the processor when a fault condition is present.

Programmable Current-Limit Threshold

A resistor from SETI to GND sets the current-limit threshold for the switch (see [Setting the Current-Limit Threshold and Current Monitoring](#) section). If the output current is limited at the current threshold value for a time equal to, or longer than,  $t_{BLANK}$  with  $V_{IN} - V_{OUT}$  higher than the FLAG assertion drop-voltage threshold ( $V_{FA}$ ), the FLAG asserts and the MAX20313/MAX20315 enter continuous current-limit mode, and the MAX20314/MAX20316 latch off the switch.

Continuous Current Limit (MAX20313/MAX20315)

When the forward current reaches the forward current threshold, the MAX20313/MAX20315 limit the output current to the programmed current limit. FLAG asserts if the current limit is present for  $t_{BLANK}$ , and deasserts when the overload condition is removed. In this mode, if the die temperature reaches +130°C (typ) due to self-heating, the part will prevent itself from consuming more power than what can be dissipated through the thermal resistance of the package. The average current limitation will be lowered automatically to a sustainable value given the thermal design. If current limitation is not the cause and the temperature continues to rise exceeding +150°C (typ), the device will go into thermal shutdown mode until the die temperature drops by approximately 20°C.

**Latchoff (MAX20314/MAX20316)**

When the forward current reaches the current threshold, the  $t_{\text{BLANK}}$  timer begins counting (Figure 2).  $\overline{\text{FLAG}}$  asserts if an overcurrent condition is present for greater than  $t_{\text{BLANK}}$  time. The timer resets if the overcurrent condition disappears before  $t_{\text{BLANK}}$  has elapsed. The switch turns off if the overcurrent condition continues beyond the blanking time. Reset the switch by either toggling the control logic (EN/ $\overline{\text{EN}}$ ) or by cycling the input voltage. If the die temperature reaches +130°C (typ) due to self-heating, the part will prevent itself from consuming more power than what can be dissipated through the thermal resistance of the package. The average current limitation will be lowered automatically to a sustainable value given the thermal design. If current limitation is not the cause and the temperature continues to rise exceeding +150°C (typ), the device will go into thermal shutdown mode until the die temperature drops by approximately 20°C.

**Current Limit Fold Back**

The devices feature a natural current limit fold back behavior once the current limit level is reached. The current limit fold back value is typically 10% of the current limit set through the SET1 resistor and is slightly dependent on die temperature and the voltage drop between IN and OUT. If the overcurrent fault is so severe that the power dissipated by the part makes it exceed the Temperature Increase Self-Limitation (130°C, typ) or that the OUT voltage falls below 1.8V, additional safe over-limitation circuitry is triggered and the average current limit of the part is further decreased even possibly to a very low and safe value. For the continuous option, to resume normal operation after an overcurrent fault, the load current needs to fall below the actual current limitation set by the part including fold back and eventual safe over-limitation.

**Switch Enable Control**

The EN/ $\overline{\text{EN}}$  controls the switch (Table 1).

**Reverse-Current Protection**

The devices feature a reverse-current protection circuit that turns the switch off when higher OUT voltage than IN voltage is sensed. The switch turns off and  $\overline{\text{FLAG}}$  asserts after accurate reverse blocking debounce time ( $t_{\text{DB\_ARIB}}$ ) in response to a lower threshold reverse fault ( $V_{\text{AREV\_TH}}$ ) or fast reverse blocking response time ( $t_{\text{FRIB}}$ ) in case of a higher threshold reverse fault ( $V_{\text{FREV\_TH}}$ ).

**Table 1. Switch Truth Table**

MAX20313 MAX20314	MAX20315 MAX20316	SWITCH STATUS
EN	$\overline{\text{EN}}$	
0	1	OFF
1	0	ON

 **$\overline{\text{FLAG}}$  Indicator**

$\overline{\text{FLAG}}$  is an open drain fault indicator output and requires an external pullup resistor to a DC supply.  $\overline{\text{FLAG}}$  goes low when any of the following conditions occur:

- An overcurrent condition after the blanking time has elapsed and  $V_{\text{IN}} - V_{\text{OUT}} > V_{\text{FA}}$
- The reverse-current protection has tripped
- The die temperature exceeds +150°C (typ)

**Temperature Increase Self-Limitation**

If the die temperature reaches +130°C, the device will prevent itself from consuming more power than what can be dissipated by the thermal resistance of the package. The feature imposes a thermal control loop between temperature and current limit level lowering the flowing current through the part when junction temperature try to rise above +130°C. Because of that, thermal design of the board has an impact on loop behavior: the average limited current is always reduced to the appropriate safe level for any thermal design but the current limit may oscillate as in auto-retry mode across the average level when the thermal resistance of the board is high.

**Thermal Shutdown**

Thermal shutdown circuitry protects the devices from overheating. The switch turns off and  $\overline{\text{FLAG}}$  goes low immediately when the junction temperature exceeds +150°C (typ). The MAX20313/MAX20315 switches turn on again after the device temperature drops by approximately 20°C (typ).

**Applications Information**

**Setting the Current-Limit Threshold and Current Monitoring**

Connect a resistor between SETI and ground to program the current limit threshold value for the devices. Table 2 shows current limit thresholds for different resistor values at SETI.

Use the following formula to calculate the current limit:

$$R_{SETI}(\Omega) = \frac{1.224(V) \times P}{I_{LIM}(A) - C(A)}$$

Do not use a  $R_{SETI}$  value smaller than 675Ω.

A current mirror is implemented with a current sense auto-zero operational amplifier. The mirrored current of the IN-OUT FET is provided on the SETI pin. Therefore, the voltage ( $V_{SETI}$ ) read on the SETI pin can be interpreted as the current through the IN-OUT FET as below:

$$I_{IN-OUT}(A) = I_{SETI}(A) \times P + C(A) = \frac{V_{SETI}(V) \times P}{R_{SETI}(\Omega)} + C(A)$$

**Note:** the current monitor feature does not provide valid information if the device is performing safe current over-limitation (die temperature > 130°C (typ) or OUT voltage < 1.8V, see [Current Limit Fold Back](#) section).

**IN Bypass Capacitor**

Connect a minimum 1μF capacitor from IN to GND to limit the input voltage drop during momentary output short-circuit conditions. If the power supply cannot support the required short-circuit current, a larger capacitor should be used to maintain the input voltage above 2.5V.

**Table 2. Current Limit Threshold vs. Resistor Values**

R <sub>SETI</sub> (Ω)	CURRENT LIMIT (A)
8350	0.5
4124	1.0
2738	1.5
2050	2.0
1638	2.5
1363	3.0
1168	3.5
1022	4.0
908	4.5
817	5.0
742	5.5
680	6.0

If the supply is not strong enough and the user does not want to use a larger capacitor at the input, the following circuitry can be used (Figure 3).

**OUT Bypass Capacitor**

For stable operation over the full temperature range and over the full programmable current-limit range, use a 1μF ceramic capacitor from OUT to ground.

Excessive output capacitance can cause a false overcurrent condition due to decreased dV/dt across the capacitor. Use the following formula to calculate the maximum capacitive load ( $C_{MAX}$ ) on OUT:

$$C_{MAX}(\mu F) = \frac{I_{LIM}(mA) \times t_{BLANK(MIN)}(ms)}{V_{IN}(V)}$$

For example, for  $V_{IN} = 5V$ ,  $t_{BLANK(MIN)} = 10ms$ , and  $I_{LIM} = 1000mA$ ,  $C_{MAX}$  equals 2000μF.

**Layout and Thermal Dissipation**

To optimize the switch response time to output short-circuit conditions, it is very important to keep all traces as short as possible to reduce the effect of undesirable parasitic inductance. Place input and output capacitors as close as possible to the device (should be no more than 5mm). IN and OUT must be connected with wide short traces to the power bus. During normal operation, the power dissipation is small and the package temperature change is minimal. If the output is continuously shorted to ground, the power dissipation for the MAX20313/MAX20315 continuous current limit version can cause the device to reach the thermal shutdown threshold.

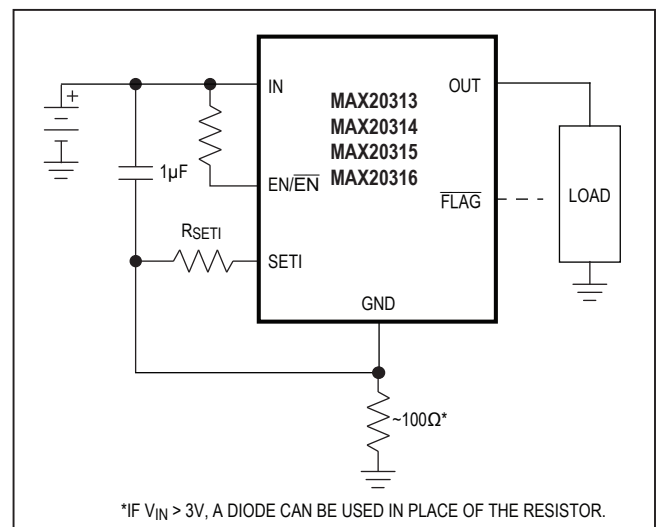
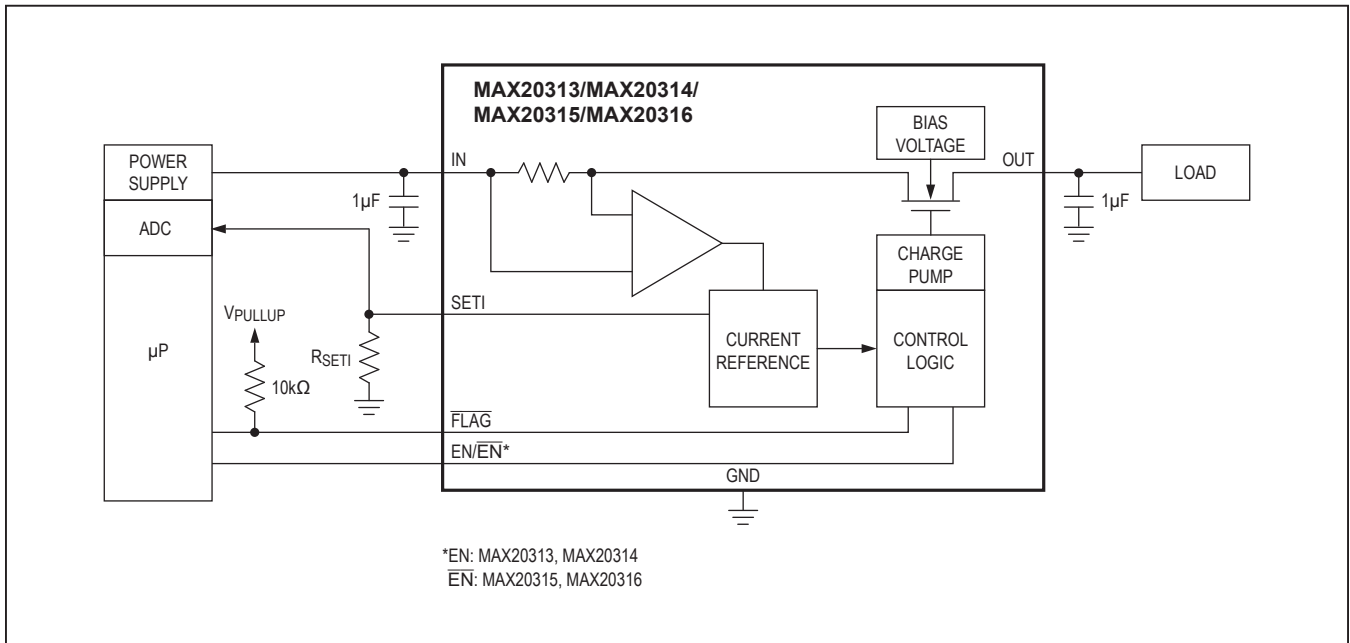

Figure 3. Optional Protection for Weak Supply

Typical Operating Circuit



Ordering Information/Selector Guide

PART	OVERCURRENT RESPONSE	EN POLARITY	TOP MARK	TEMP RANGE	PIN-PACKAGE
MAX20313EWC+T	Continuous	Active-High	ADT	-40°C TO +85°C	12 WLP
MAX20314EWC+T	Latchoff	Active-High	ADU	-40°C TO +85°C	12 WLP
MAX20315EWC+T	Continuous	Active-Low	ADV	-40°C TO +85°C	12 WLP
MAX20316EWC+T	Latchoff	Active-Low	ADW	-40°C TO +85°C	12 WLP

+Denotes a lead(Pb)-free/RoHS-compliant package.

T = Tape and reel.

Chip Information

PROCESS: BICMOS

## Revision History

REVISION NUMBER	REVISION DATE	DESCRIPTION	PAGES CHANGED
0	6/17	Initial release	—
1	3/18	Updated <i>Ordering Information</i> table	13
2	3/19	Updated the <i>Electrical Characteristics</i> table and Table 2	2, 12

For pricing, delivery, and ordering information, please visit Maxim Integrated's online storefront at <https://www.maximintegrated.com/en/storefront/storefront.html>.

Maxim Integrated cannot assume responsibility for use of any circuitry other than circuitry entirely embodied in a Maxim Integrated product. No circuit patent licenses are implied. Maxim Integrated reserves the right to change the circuitry and specifications without notice at any time. The parametric values (min and max limits) shown in the *Electrical Characteristics* table are guaranteed. Other parametric values quoted in this data sheet are provided for guidance.