



Technical Data Sheet

Light Emitting Diode (5 mm Round LED,T-1 3/4)

7343-2USOC/S530-AX

Features

- Popular T-1 3/4 diameter package.
- Choice of various viewing angles.
- Reliable and robust.
- Pb free
- The product itself will remain within RoHS compliant version.



Descriptions

- The series is specially designed for applications requiring higher brightness.
- The LED lamps are available with different colors,intensities,epoxy colors, etc.

Applications

- TV set.
- Monitor.
- Telephone.
- Computer.

Device Selection Guide

Chip		Lens Color
Material	Emitted Color	
AlGaInP	Super Orange	Water Clear

Technical Data Sheet

Light Emitting Diode (5 mm Round LED,T-1 3/4)

7343-2USOC/S530-AX

Package Dimensions

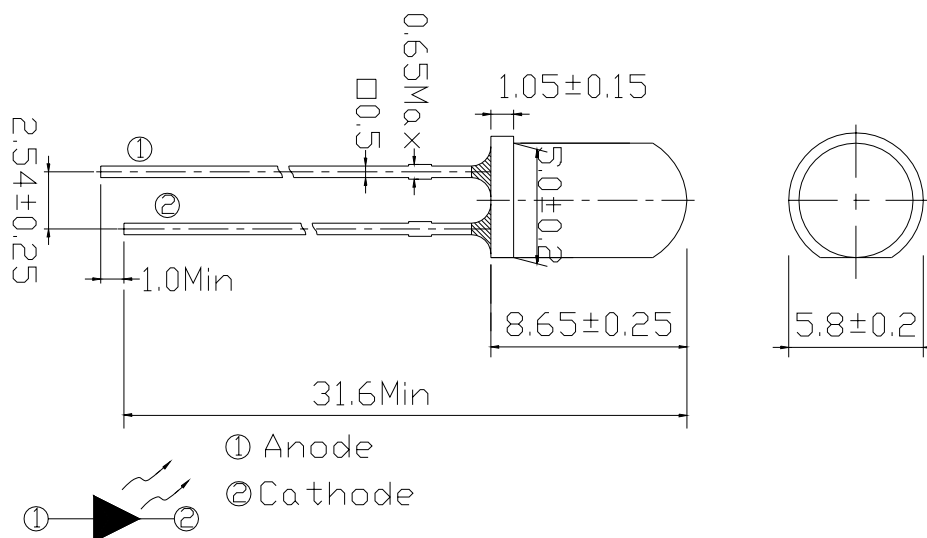

Notes:

- All dimensions are in millimeters, tolerance is 0.25mm except being specified.
- Lead spacing is measured where the lead emerges from the package.
- Protruded resin under flange is 1.5mm Max LED.

Absolute Maximum Ratings (Ta=25°C)

Parameter	Symbol	Rating	Units
Forward Current	I _F	25	mA
Pulse Forward Current ^{*1}	I _{FP}	60	mA
Operating Temperature	T _{opr}	-40 ~ +120	°C
Storage Temperature	T _{stg}	-40 ~ +120	°C
Electrostatic Discharge	ESD	2000	V
Soldering Temperature ^{*2}	T _{sol}	260 ±5	°C
Power Dissipation	P _d	60	mW
Reverse Voltage	V _R	5	V

Notes: *1:I_{FP} Conditions--Pulse Width ≤ 10msec and Duty ≤ 1/10.

*2:Soldering time ≤ 5 seconds.



Technical Data Sheet

Light Emitting Diode (5 mm Round LED,T-1 3/4)

7343-2USOC/S530-AX

Electro-Optical Characteristics (Ta=25°C)

Parameter	Symbol	Condition	Chip Rank	Min.	Typ.	Max.	Units
Forward Voltage	V _F	I _F =20mA	--	--	2.0	2.4	V
Reverse Current	I _R	V _R =5V	--	--	--	10	μA
Luminous Intensity	I _v	I _F =20mA	A3	500	800	--	mcd
			A4	630	1000	--	
			A5	800	1250	--	
Viewing Angle	2 θ 1/2	I _F =20mA	--	--	25	--	deg
Peak Wavelength	λ _p	I _F =20mA	--	--	621	--	nm
Dominant Wavelength	λ _d	I _F =20mA	--	--	615	--	nm
Spectrum Radiation Bandwidth	Δ λ	I _F =20mA	--	--	18	--	nm

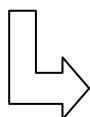
***7343-2USOC/S530-AX**

Chip Rank



Technical Data Sheet

Light Emitting Diode (5 mm Round LED,T-1 3/4)

7343-2USOC/S530-AX

Typical Electro-Optical Characteristics Curves

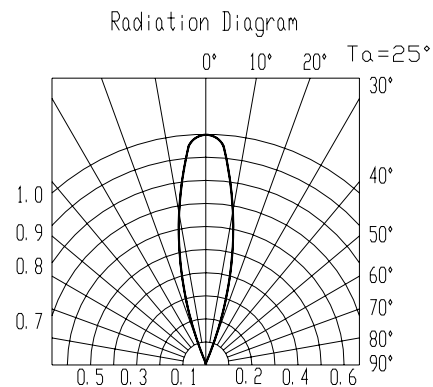
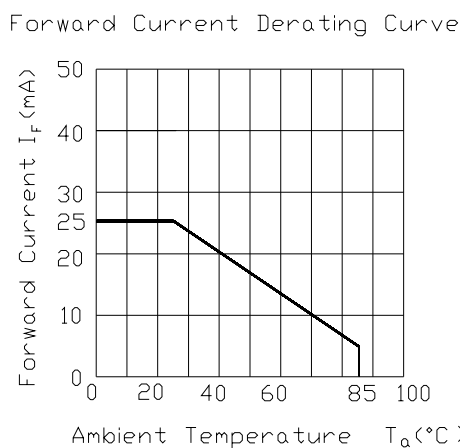
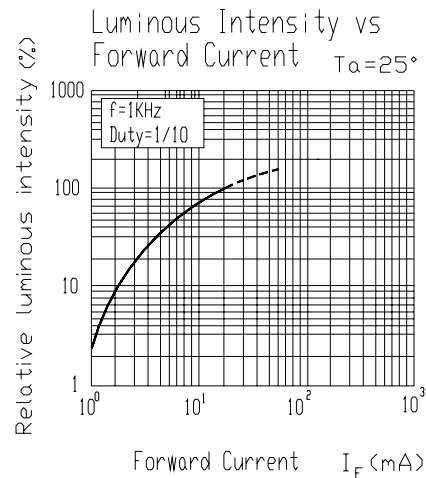
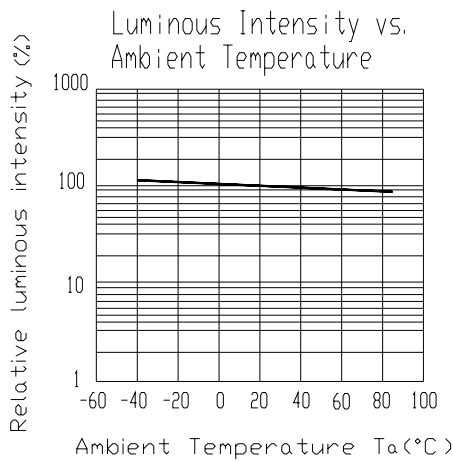
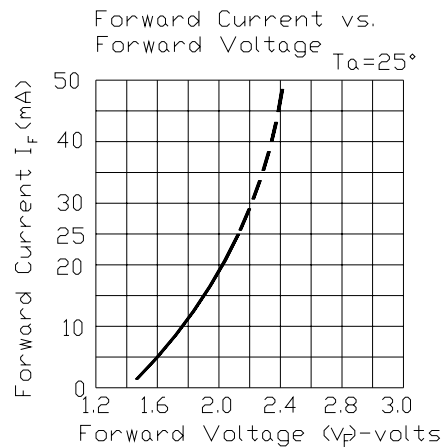
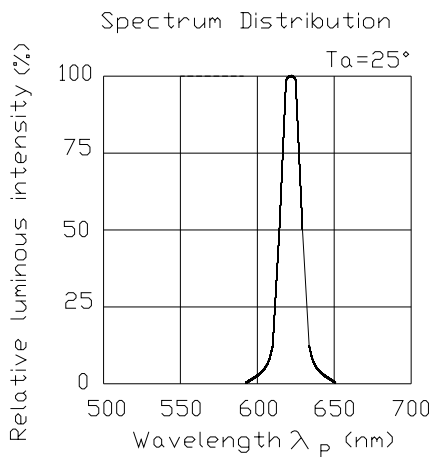





Technical Data Sheet

Light Emitting Diode (5 mm Round LED,T-1 3/4)

7343-2USOC/S530-AX

Label Form Specification

EVERLIGHT	
CPN:	
P/N:	
 RoHS	
7343USOC/S530-AX	
QTY :	CAT:
	HUE:
LOT NO :	REF:
	
MADE IN TAIWAN	

CPN: Customer's Production Number
P/N : Production Number
QTY: Packing Quantity
CAT: Ranks of Luminous and Forward Voltage
HUE: Ranks of Dominant Wavelength
REF: Reference
LOT No: Lot Number
MADE IN TAIWAN: Production Place

Notes

1. Above specification may be changed without notice. EVERLIGHT will reserve authority on material change for above specification.
2. When using this product, please observe the absolute maximum ratings and the instructions for using outlined in these specification sheets. EVERLIGHT assumes no responsibility for any damage resulting from use of the product which does not comply with the absolute maximum ratings and the instructions included in these specification sheets.
3. These specification sheets include materials protected under copyright of EVERLIGHT corporation. Please don't reproduce or cause anyone to reproduce them without EVERLIGHT's consent.

EVERLIGHT ELECTRONICS CO., LTD.
Office: No 25, Lane 76, Sec 3, Chung Yang Rd,
Tucheng, Taipei 236, Taiwan, R.O.C

Tel: 886-2-2267-2000, 2267-9936
Fax: 886-2267-6244, 2267-6189, 2267-6306
http://www.everlight.com