

OPTIONAL FANS  
DNMF100AC115  
DNMF100AC230

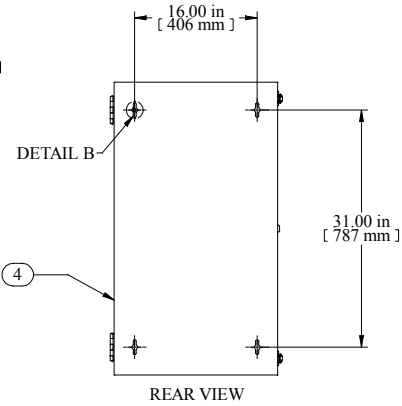
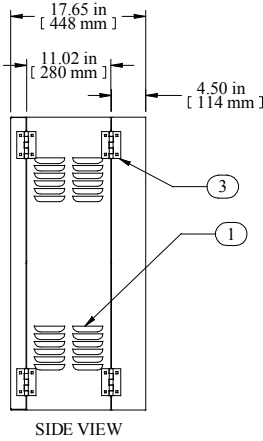
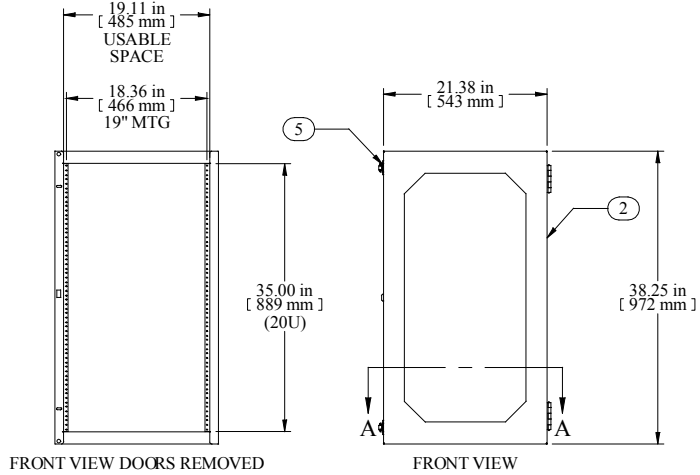
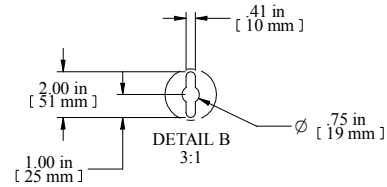
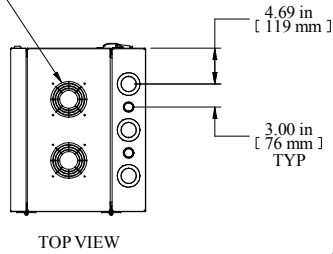

Item Number	Title	Quantity
1	SWC - WELDED BODY	1
2	SWC - PLEXI DOOR	1
3	SWC - HINGE	4
4	SWC - WELDED REAR TUB	1
5	SWC - REAR TUB LATCH	2
6	COMBINATION RAILS TAPPED (PAIR)	1

PART NUMBERS

SWC193511BK1	PAINTED BLACK TEXTURED PLEXI FRONT DOOR
SWC193511SBK1	PAINTED BLACK TEXTURED SOLID FRONT DOOR

NOTES

See Hammond Website for Additional Accessories

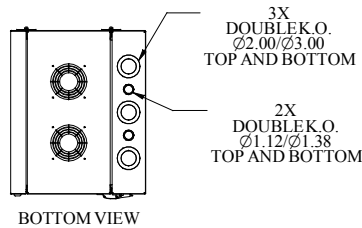

Data subject to change without notice. Isometric drawing not to scale.

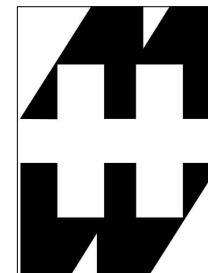

**HAMMOND  
MANUFACTURING™**

www.hammondmfg.com

PART NO. SWC193511