

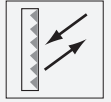

Reflector REF-H160

- Mounting holes for simple installation



Reflector, rectangular 60 mm x 18 mm, mounting holes

Dimensions

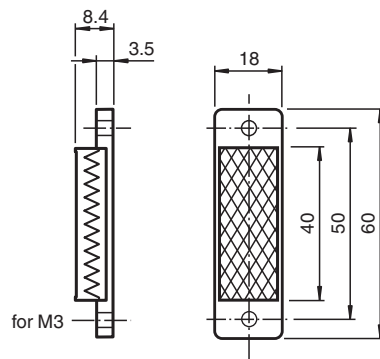

Technical Data

General specifications

Construction type rectangular

Ambient conditions

Ambient temperature -20 ... 60 °C (-4 ... 140 °F)

Mechanical specifications

Material PMMA/ABS

Dimensions 60 mm x 18 mm x 8.4 mm

Mounting mounting holes