

## MAX2850

## 5GHz, 4-Channel MIMO Transmitter

### General Description

The MAX2850 is a single-chip, 4-channel RF transmitter IC designed for 5GHz wireless HDMI applications. The IC includes all circuitry required to implement the complete 4-channel MIMO RF transmitter function and crystal oscillator, providing a fully integrated transmit path, VCO, frequency synthesis, and baseband/control interface. It includes a fast-settling, sigma-delta RF fractional synthesizer with 76Hz frequency programming step size. The IC also integrates on-chip I/Q amplitude and phase-error calibration circuits. Dynamic on/off control of four external PAs is implemented with programmable precision voltages. A 4-to-1 analog mux routes external PA power-detect voltages to the RSSI pin.

On-chip monolithic filters are included for transmitter I/Q baseband signal reconstruction to support both 20MHz and 40MHz RF channels. The baseband filtering and Tx signal paths are optimized to meet stringent WHDI requirements. The upconverter local oscillator is coherent among all the transmitter channels.

The reverse-link control channel uses an on-chip 5GHz OFDM receiver. It shares the RF synthesizer and LO generation circuit with the MIMO transmitters. The receiver includes both an in-channel RSSI and an RF RSSI.

The MIMO transmitter chip is housed in a small, 68-pin thin QFN leadless plastic package with exposed pad.

### Applications

- 5GHz Wireless HDMI (WHDI)
- 5GHz FDD Backhaul and WiMax™
- 5GHz MIMO Transmitter Up to Four Spatial Streams
- 5GHz Beam Steering Transmitter

WiMax is a trademark of WiMax Forum.  
SPI is a trademark of Motorola, Inc.

### Features

- 5GHz 4x MIMO Downlink Transmitters, Single Uplink IEEE 802.11a Receiver
    - 4900MHz to 5900MHz Frequency Range
    - -5dBm Transmit Power (54Mbps OFDM)
    - Coherent LO Among Transmitters
    - 31dB Tx Gain-Control Range with 0.5dB Step Size, Digitally Controlled Tx/Rx I/Q Error and LO Leakage Detection and Adjustment
  - Programmable 20MHz/40MHz Tx I/Q Lowpass Anti-Aliasing Filter
  - 4-to-1 Analog Mux for PA Power Detect
  - 4-Channel PA On/Off Control
  - 4.5dB Rx Noise Figure
  - 70dB Rx Gain-Control Range with 2dB Step Size, Digitally Controlled
  - 60dB Dynamic Range Receiver RSSI
  - RF Wideband Receiver RSSI
  - Programmable 20MHz/40MHz Rx I/Q Lowpass Channel Filters
  - Sigma-Delta Fractional-N PLL with 76Hz Resolution
  - Monolithic Low-Noise VCO with -35dBc Integrated Phase Noise
  - 4-Wire SPI™ Digital Interface
  - I/Q Analog Baseband Interface
  - Digital Tx/Rx Mode Control
  - On-Chip Digital Temperature Sensor Readout
  - Complete Baseband Interface
  - Digital Tx/Rx Mode Control
- +2.7V to +3.6V Supply Voltage
  - Small, 68-Pin Thin QFN Package (10mm x 10mm)

### Ordering Information

PART	TEMP RANGE	PIN-PACKAGE
MAX2850ITK+	-25°C to +85°C	68 Thin QFN-EP*

\*EP = Exposed pad.

+Denotes a lead(Pb)-free/RoHS-compliant package.

**Typical Operating Circuit appears at end of data sheet.**

**Absolute Maximum Ratings**

V<sub>CC\_</sub> Pins to GND .....-0.3V to +3.9V  
 RF Inputs Maximum Current: RXRF+, RXRF- to GND.....-1mA to +1mA  
 RF Outputs: TXRF1+, TXRF1-, TXRF2+, TXRF2-, TXRF3+, TXRF3-, TXRF4+, TXRF4- to GND.....-0.3V to V<sub>CC\_</sub> + 0.6V  
 Analog Inputs: TXBB1I+, TXBB1I-, TXBB1Q+, TXBB1Q-, TXBB2I+, TXBB2I-, TXBB2Q+, TXBB2Q-, TXBB3I+, TXBB3I-, TXBB3Q+, TXBB3Q-, TXBB4I+, TXBB4I-, TXBB4Q+, TXBB4Q-, PA\_DET1, PA\_DET2, PA\_DET3, PA\_DET4, XTAL, XTAL\_CAP to GND .....-0.3V to V<sub>CC\_</sub> + 0.3V  
 Analog Outputs: RXBBI+, RXBBI-, RXBBQ+, RXBBQ-, RSSI, CLKOUT2, VCOBYP, CPOUT+, CPOUT-, PA\_BIAS1, PA\_BIAS2, PA\_BIAS3, PA\_BIAS4 to GND .....-0.3V to V<sub>CC\_</sub> + 0.3V

Digital Inputs: ENABLE,  $\overline{CS}$ , SCLK, DIN to GND.....-0.3V to V<sub>CC\_</sub> + 0.3V  
 Digital Outputs: DOUT, CLKOUT to GND..-0.3V to V<sub>CC\_</sub> + 0.3V  
 Short-Circuit Duration  
 Analog Outputs ..... 10s  
 Digital Outputs ..... 10s  
 RF Input Power .....+10dBm  
 RF Output Differential Load VSWR..... 6:1  
 Continuous Power Dissipation (T<sub>A</sub> = +85°C)  
 68-Pin Thin QFN (derate 29.4mW/°C above +70°C) ..235mW  
 Operating Temperature Range..... -25°C to +85°C  
 Junction Temperature..... +150°C  
 Storage Temperature Range ..... -65°C to +160°C  
 Lead Temperature (soldering, 10s) ..... +300°C  
 Soldering Temperature (reflow) ..... +260°C

Stresses beyond those listed under "Absolute Maximum Ratings" may cause permanent damage to the device. These are stress ratings only, and functional operation of the device at these or any other conditions beyond those indicated in the operational sections of the specifications is not implied. Exposure to absolute maximum rating conditions for extended periods may affect device reliability.

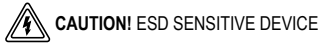

**DC Electrical Characteristics**

(Operating conditions, unless otherwise specified: V<sub>CC</sub> = 2.7V~3.6V, ENABLE set according to operating mode,  $\overline{CS}$  = high, SCLK = DIN = low, transmitter in maximum gain, T<sub>A</sub> = -25°C to +85°C. Power matching and termination for the differential RF output pins using the *Typical Operating Circuit*. 100mV<sub>RMS</sub> differential I and Q signals applied to I/Q baseband inputs of transmitters in transmit mode. Typical values measured at V<sub>CC</sub> = 2.85V, T<sub>A</sub> = +25°C, LO frequency = 5.35GHz, T<sub>A</sub> = +25°C. Channel bandwidth is set to 40MHz. PA control pins open circuit, V<sub>CC\_PA\_BIAS</sub> is disconnected.) (Note 1)

PARAMETERS	CONDITIONS		MIN	TYP	MAX	UNITS
Supply Voltage, V <sub>CC</sub>			2.7		3.6	V
Supply Current	Shutdown mode	T <sub>A</sub> = +25°C		10		μA
	Clock-out only mode	XTAL oscillator, load = 10pF		3		
		TCXO input, load = 10kΩ  10pF		7.4	11	
	Standby mode			60	89	
	Transmit mode	One transmitter is on		188	235	
		Four transmitters are on		505	661	mA
	Receive mode			135	174	
Transmit calibration mode	One transmitter is on		214	261		
	Four transmitters are on		532	686		
Receive calibration mode			268	327		
Rx I/Q Output Common-Mode Voltage			0.9	1.1	1.3	V
Tx Baseband Input Common-Mode Voltage Operating Range			0.5		1.1	V
Tx Baseband Input Bias Current	Source current			10	20	μA

## Electrical Characteristics (continued)

(Operating conditions, unless otherwise specified:  $V_{CC} = 2.7V\sim 3.6V$ , ENABLE set according to operating mode,  $\overline{CS} = \text{high}$ , SCLK = DIN = low, transmitter in maximum gain,  $T_A = -25^\circ\text{C}$  to  $+85^\circ\text{C}$ . Power matching and termination for the differential RF output pins using the *Typical Operating Circuit*. 100mV<sub>RMS</sub> differential I and Q signals applied to I/Q baseband inputs of transmitters in transmit mode. Typical values measured at  $V_{CC} = 2.85V$ ,  $T_A = +25^\circ\text{C}$ , LO frequency = 5.35GHz,  $T_A = +25^\circ\text{C}$ . Channel bandwidth is set to 40MHz. PA control pins open circuit,  $V_{CC\_PA\_BIAS}$  is disconnected.) (Note 1)

PARAMETERS	CONDITIONS	MIN	TYP	MAX	UNITS
<b>LOGIC INPUTS: ENABLE, SCLK, DIN, <math>\overline{CS}</math></b>					
Digital Input-Voltage High, $V_{IH}$		$V_{CC} - 0.4$			V
Digital Input-Voltage Low, $V_{IL}$				0.3	V
Digital Input-Current High, $I_{IH}$		-1		+1	$\mu\text{A}$
Digital Input-Current Low, $I_{IL}$		-1		+1	$\mu\text{A}$
<b>LOGIC OUTPUTS: DOUT, CLKOUT</b>					
Digital Output-Voltage High, $V_{OH}$	Sourcing 1mA	$V_{CC} - 0.4$			V
Digital Output-Voltage Low, $V_{OL}$	Sinking 1mA			0.4	V
Digital Output Voltage in Shutdown Mode	Sinking 1mA		$V_{OL}$		V

## AC Electrical Characteristics—Rx Mode

(Operating conditions, unless otherwise specified:  $V_{CC} = 2.7V\sim 3.6V$ , RF frequency = 5.351GHz,  $T_A = -25^\circ\text{C}$  to  $+85^\circ\text{C}$ . LO frequency = 5.35GHz. Reference frequency = 40MHz, ENABLE = high,  $\overline{CS} = \text{high}$ , SCLK = DIN = low, with power matching at RXRF+ and RXRF- differential ports using the *Typical Operating Circuit*. Receiver I/Q output at 100mV<sub>RMS</sub> loaded with 10k $\Omega$  differential load resistance and 10pF load capacitance. The RSSI pin is loaded with 10k $\Omega$  load resistance to ground. Typical values measured at  $V_{CC} = 2.85V$ , channel bandwidths of 40MHz,  $T_A = +25^\circ\text{C}$ .) (Note 1)

PARAMETER	CONDITIONS	MIN	TYP	MAX	UNITS
<b>RECEIVER SECTION: RF INPUT TO I/Q BASEBAND LOADED OUTPUT (INCLUDES 50<math>\Omega</math> TO 100<math>\Omega</math> RF BALUN AND MATCHING)</b>					
RF Input Frequency Range		4.9		5.9	GHz
Peak-to-Peak Gain Variation over RF Frequency Range at One Temperature	4.9GHz to 5.35GHz		0.3	2.6	dB
	5.35GHz to 5.9GHz		2.2	5.3	
RF Input Return Loss	All LNA settings		-6		dB
Total Voltage Gain	Maximum gain; Main address 1 D7:0 = 11111111	61	68		dB
	Minimum gain; Main address 1 D7:0 = 00000000		-2	+5	
RF Gain Steps Relative to Maximum Gain	Main address 1 D7:D5 = 110		-8		dB
	Main address 1 D7:D5 = 101		-16		
	Main address 1 D7:D5 = 001		-32		
	Main address 1 D7:D5 = 000		-40		
Baseband Gain Range	From maximum baseband gain (Main address 1 D3:D0 = 1111) to minimum baseband gain (Main address 1 D3:D0 = 0000)	27.5	30	32.5	dB
Baseband Gain Step			2		dB
RF Gain Change Settling Time	Gain settling to within $\pm 0.5\text{dB}$ of steady state; RXHP = 1		400		ns

### AC Electrical Characteristics—Rx Mode (continued)

(Operating conditions, unless otherwise specified:  $V_{CC} = 2.7V \sim 3.6V$ , RF frequency = 5.351GHz,  $T_A = -25^\circ C$  to  $+85^\circ C$ . LO frequency = 5.35GHz. Reference frequency = 40MHz, ENABLE = high, CS = high, SCLK = DIN = low, with power matching at RXRF+ and RXRF- differential ports using the *Typical Operating Circuit*. Receiver I/Q output at 100mV<sub>RMS</sub> loaded with 10kΩ differential load resistance and 10pF load capacitance. The RSSI pin is loaded with 10kΩ load resistance to ground. Typical values measured at  $V_{CC} = 2.85V$ , channel bandwidths of 40MHz,  $T_A = +25^\circ C$ .) (Note 1)

PARAMETER	CONDITIONS		MIN	TYP	MAX	UNITS
Baseband Gain-Change Settling Time	Gain settling to within $\pm 0.5dB$ of steady state; RXHP = 1			200		ns
DSB Noise Figure	Balun input referred, integrated from 10kHz to 9.5MHz at I/Q baseband output for 20MHz RF bandwidth	Maximum RF gain (Main address 1 D7:D5 = 111)		4.5		dB
		Maximum RF gain - 16dB (Main address 1 D7:D5 = 101)		15		
	Balun input referred, integrated from 10kHz to 19MHz at I/Q baseband output for 40MHz RF bandwidth	Maximum RF gain (Main address 1 D7:D5 = 111)		4.5		
		Maximum RF gain - 16dB (Main address 1 D7:D5 = 101)		15		
Out-of-Band Input IP3	20MHz RF channel; two tone jammers at +25MHz and +48MHz frequency offset with -39dBm/tone	-65dBm wanted signal; RF gain = max (Main address 1 D7:D0 = 11101001)		-13		dBm
		-49dBm wanted signal; RF gain = max - 16dB (Main address 1 D7:D0 = 10101001)		-5		
		-45dBm wanted signal; RF gain = max - 32dB (Main address 1 D7:D0 = 00111111)		11		
	40MHz RF channel; two tone jammers at +50MHz and +96MHz frequency offset with -39dBm/tone	-65dBm wanted signal; RF gain = max (Main address 1 D7:D0 = 11101001)		-13		
		-49dBm wanted signal; RF gain = max - 16dB (Main address 1 D7:D0 = 10101001)		-5		
		-45dBm wanted signal; RF gain = max - 32dB (Main address 1 D7:D0 = 00101001)		11		
1dB Gain Desensitization by Alternate Channel Blocker	Blocker at $\pm 40MHz$ offset frequency for 20MHz RF channel			-24		dBm
	Blocker at $\pm 80MHz$ offset frequency for 40MHz RF channel			-24		
Input 1dB Gain Compression	Max RF gain (Main address 1 D7:D5 = 111)			-32		dBm
	Max RF gain - 8dB (Main address 1 D7:D5 = 110)			-24		
	Max RF gain - 16dB (Main address 1 D7:D5 = 101)			-16		
	Max RF gain - 32dB (Main address 1 D7:D5 = 001)			0		
Output 1dB Gain Compression	Over passband frequency range; at any gain setting; 1dB compression point			0.63		V <sub>P-P</sub>

### AC Electrical Characteristics—Rx Mode (continued)

(Operating conditions, unless otherwise specified:  $V_{CC} = 2.7V \sim 3.6V$ , RF frequency = 5.351GHz,  $T_A = -25^\circ C$  to  $+85^\circ C$ . LO frequency = 5.35GHz. Reference frequency = 40MHz, ENABLE = high,  $\overline{CS} =$  high, SCLK = DIN = low, with power matching at RXRF+ and RXRF- differential ports using the *Typical Operating Circuit*. Receiver I/Q output at  $100mV_{RMS}$  loaded with 10k $\Omega$  differential load resistance and 10pF load capacitance. The RSSI pin is loaded with 10k $\Omega$  load resistance to ground. Typical values measured at  $V_{CC} = 2.85V$ , channel bandwidths of 40MHz,  $T_A = +25^\circ C$ .) (Note 1)

PARAMETER	CONDITIONS	MIN	TYP	MAX	UNITS
Baseband -3dB Lowpass Corner Frequency	Main address 0 D1 = 0		9.5		MHz
	Main address 0 D1 = 1		19		
Baseband Filter Stopband Rejection	Rejection at 30MHz offset frequency for 20MHz channel	57	70		dB
	Rejection at 60MHz offset frequency for 40MHz channel	57	70		
Baseband -3dB Highpass Corner Frequency	Main address 5 D1 = 1		600		kHz
	Main address 5 D1 = 0		10		
Steady-State I/Q Output DC Error with AC-Coupling	50 $\mu s$ after enabling receive mode and toggling RxHP from 1 to 0, averaged over many measurements if I/Q noise voltage exceeds $1mV_{RMS}$ , at any given gain setting, no input signal, 1-sigma value		2		mV
I/Q Gain Imbalance	1MHz baseband output, 1-sigma value		0.1		dB
I/Q Phase Imbalance	1MHz baseband output, 1-sigma value		0.2		degrees
Sideband Suppression	1MHz baseband output (Note 2)		40		dB
Receiver Spurious Signal Emissions	LO frequency		-75		dBm/ MHz
	2 x LO frequency		-62		
	3 x LO frequency		-75		
	4 x LO frequency		-60		
RF RSSI Output Voltage	-20dBm input power		1.75		V
Baseband RSSI Slope		19.5	26.5	35.5	mV/dB
Baseband RSSI Maximum Output Voltage			2.3		V
Baseband RSSI Minimum Output Voltage			0.5		V
RF Loopback Conversion Gain	Tx VGA gain at maximum (Main address 9 D9:D4 = 111111); Rx VGA gain at maximum - 24dB (Main address 1 D3:D0 = 0101)	-6	+2	+10	dB

### AC Electrical Characteristics—Tx Mode

(Operating conditions, unless otherwise specified:  $V_{CC} = 2.7V \sim 3.6V$ , RF frequency = 5.351GHz,  $T_A = -25^\circ C$  to  $+85^\circ C$ . LO frequency = 5.35GHz. Reference frequency = 40MHz, ENABLE = high,  $\overline{CS} =$  high, SCLK = DIN = low, with power matching at TXRF+ and TXRF- differential ports using the *Typical Operating Circuit*. 100mV $_{RMS}$  sine and cosine signal applied to I/Q baseband inputs of transmitter (differential DC-coupled). Typical values measured at  $V_{CC} = 2.85V$ , channel bandwidths of 40MHz,  $T_A = +25^\circ C$ .) (Note 1)

PARAMETER	CONDITIONS	MIN	TYP	MAX	UNITS
<b>TRANSMIT SECTION: Tx BASEBAND I/Q INPUTS TO RF OUTPUTS (INCLUDES MATCHING AND BALUN LOSS)</b>					
RF Output Frequency Range		4.9		5.9	GHz
Peak-to-Peak Gain Variation over RF Band	At one temperature		3	6.4	dB

### AC Electrical Characteristics—Tx Mode (continued)

(Operating conditions, unless otherwise specified:  $V_{CC} = 2.7V\sim 3.6V$ , RF frequency = 5.351GHz,  $T_A = -25^\circ C$  to  $+85^\circ C$ . LO frequency = 5.35GHz. Reference frequency = 40MHz, ENABLE = high,  $\overline{CS}$  = high, SCLK = DIN = low, with power matching at TXRF+ and TXRF- differential ports using the *Typical Operating Circuit*. 100mV<sub>RMS</sub> sine and cosine signal applied to I/Q baseband inputs of transmitter (differential DC-coupled). Typical values measured at  $V_{CC} = 2.85V$ , channel bandwidths of 40MHz,  $T_A = +25^\circ C$ .) (Note 1)

PARAMETER	CONDITIONS	MIN	TYP	MAX	UNITS
Maximum Output Power	20MHz OFDM signal conforming to spectral emission mask and -34dB EVM		-4		dBm
	40MHz OFDM signal conforming to spectral emission mask and -34dB EVM		-4		
Output 1dB Gain Compression	Relative to typical maximum output power at 9.5MHz input frequency		11		dBc
Input 1dB Gain Compression	At 19MHz input frequency, over input common-mode voltage between 0.5V and 1.1V		380		mV <sub>RMS</sub>
Gain-Control Range		26	31.5	34.5	dB
Gain-Control Step			0.5		dB
RF Output Return Loss			-3		dB
Unwanted Sideband	Over RF channel, RF frequency, baseband frequency, and gain settings (Note 2)		-40		dBc
Carrier Leakage	Over RF channel, RF frequency, and gain settings (Note 2)		-29	-15	dBc
Tx I/Q Input Impedance (R  C)	Minimum differential resistance		60		k $\Omega$
	Maximum differential capacitance		2		pF
Baseband Filter Stopband Rejection	At 30MHz frequency offset for 20MHz RF channel		86		dB
	At 60MHz frequency offset for 40MHz RF channel		67		
Tx Calibration Ftone Level	At Tx gain code (Main address 9 D9:D4) = 100010 and -15dBc carrier leakage (Local address 27 D2:D0 = 110 and Main address 1 D3:D0 = 0000)		-28		dBV <sub>RMS</sub>
Tx Calibration Gain Range	Adjust Local address 27 D2:D0		35		dB

### AC Electrical Characteristics—Frequency Synthesis

(Operating conditions, unless otherwise specified:  $V_{CC} = 2.7V\sim 3.6V$ , frequency = 5.35GHz,  $T_A = -25^\circ C$  to  $+85^\circ C$ . Reference frequency = 40MHz, ENABLE = high,  $\overline{CS}$  = high, SCLK = DIN = low. Typical values measured at  $V_{CC} = 2.85V$ , LO frequency = 5.35GHz,  $T_A = +25^\circ C$ .) (Note 1)

PARAMETER	CONDITIONS	MIN	TYP	MAX	UNITS
<b>FREQUENCY SYNTHESIZER</b>					
RF Channel Center Frequency		4.9		5.9	GHz
Channel Center Frequency Programming Step			76.294		Hz
Closed-Loop Integrated Phase Noise	Loop BW = 200kHz, integrate phase noise from 1kHz to 10MHz		-35		dBc
Charge-Pump Output Current			0.8		mA
Spur Level	$f_{OFFSET} = 0$ to 19MHz		-42		dBc
	$f_{OFFSET} = 40$ MHz		-66		
Reference Frequency			40		MHz

### AC Electrical Characteristics—Frequency Synthesis (continued)

(Operating conditions, unless otherwise specified:  $V_{CC} = 2.7V\sim 3.6V$ , frequency = 5.35GHz,  $T_A = -25^\circ C$  to  $+85^\circ C$ . Reference frequency = 40MHz, ENABLE = high,  $\overline{CS} =$  high, SCLK = DIN = low. Typical values measured at  $V_{CC} = 2.85V$ , LO frequency = 5.35GHz,  $T_A = +25^\circ C$ .) (Note 1)

PARAMETER	CONDITIONS	MIN	TYP	MAX	UNITS
Reference Frequency Input Levels	AC-coupled to XTAL pin	800			mV <sub>P-P</sub>
Maximum Crystal Motional Resistance			50		$\Omega$
Crystal Capacitance Tuning Range	Base-to-ground capacitance		30		pF
Crystal Capacitance Tuning Step			140		fF
CLKOUT Signal Level	10pF load capacitance	$V_{CC} - 0.8$	$V_{CC} - 0.1$		V <sub>P-P</sub>

### AC Electrical Characteristics—Miscellaneous Blocks

(Operating conditions, unless otherwise specified:  $V_{CC} = 2.7V\sim 3.6V$ ,  $T_A = -25^\circ C$  to  $+85^\circ C$ . Reference frequency = 40MHz, ENABLE = high,  $\overline{CS} =$  high, SCLK = DIN = low. Typical values measured at  $V_{CC} = 2.85V$ ,  $T_A = +25^\circ C$ .) (Note 1)

PARAMETER	CONDITIONS	MIN	TYP	MAX	UNITS
<b>PA POWER DETECTOR MUX</b>					
Output-Voltage Drop	$V_{IN} = 2V$ , load resistance = 10k $\Omega$ to ground		11	30	mV
<b>PA ON/OFF CONTROL</b>					
$V_{CC\_PA}$ Input Voltage Range		3.1		3.6	V
$V_{CC\_PA}$ Supply Current	With 10mA load at PA_BIAS1 to PA_BIAS4		42		mA
Output High Level	10mA load current, Main address 11 D7:5 = 011		2.8		V
Output High-Level Variation Between PA_BIAS1 to PA_BIAS4			30		mV
Output Low Level	1mA load current, Main address 11 D7:5 = 011		25		mV
Turn-On Time	Measured from $\overline{CS}$ rising edge		0.3		$\mu s$
<b>ON-CHIP TEMPERATURE SENSOR</b>					
Digital Output Code	Read-out at DOUT pin through Main address 3 D4:D0	$T_A = +25^\circ C$	17		
		$T_A = +85^\circ C$	25		
		$T_A = -20^\circ C$	9		

### AC Electrical Characteristics—Timing

(Operating conditions, unless otherwise specified:  $V_{CC} = 2.7V\sim 3.6V$ , frequency = 5.35GHz,  $T_A = -25^\circ C$  to  $+85^\circ C$ ., Reference frequency = 40MHz, ENABLE = high,  $\overline{CS} =$  high, SCLK = DIN = low, typical values measured at  $V_{CC} = 2.85V$ , LO frequency = 5.35GHz,  $T_A = +25^\circ C$ .) (Note 1)

PARAMETER	SYMBOL	CONDITIONS	MIN	TYP	MAX	UNITS
<b>SYSTEM TIMING</b>						
Shutdown Time				2		$\mu s$
Maximum Channel Switching Time		Loop bandwidth = 200kHz, settling to within $\pm 1kHz$ from steady state		2		ms
Maximum Channel Switching Time With Preselected VCO Sub-Band		Loop bandwidth = 200kHz, settling to within $\pm 1kHz$ from steady state		56		$\mu s$

### AC Electrical Characteristics—Timing (continued)

(Operating conditions, unless otherwise specified:  $V_{CC} = 2.7V \sim 3.6V$ , frequency = 5.35GHz,  $T_A = -25^\circ C$  to  $+85^\circ C$ ,. Reference frequency = 40MHz, ENABLE = high,  $\overline{CS} =$  high, SCLK = DIN = low, typical values measured at  $V_{CC} = 2.85V$ , LO frequency = 5.35GHz,  $T_A = +25^\circ C$ .) (Note 1)

PARAMETER	SYMBOL	CONDITIONS		MIN	TYP	MAX	UNITS
Rx/Tx Turnaround Time		Measured from $\overline{CS}$ rising edge	Rx to Tx mode, Tx gain settles to within 0.2dB of steady state		2		$\mu s$
			Tx to Rx mode with RXHP = 1, Rx gain settles to within 0.5dB of steady state		2		
Tx Turn-On Time (from Standby Mode)		Measured from $\overline{CS}$ rising edge, Tx gain settles to within 0.2dB of steady state			2		$\mu s$
Tx Turn-Off Time (to Standby Mode)		From $\overline{CS}$ rising edge			0.1		$\mu s$
Rx Turn-On Time (from Standby Mode)		Measured from $\overline{CS}$ rising edge, Rx gain settles to within 0.5dB of steady state			2		$\mu s$
Rx Turn-Off Time (to Standby Mode)		From $\overline{CS}$ rising edge			0.1		$\mu s$
<b>4-WIRE SERIAL-INTERFACE TIMING (SEE FIGURE 1)</b>							
SCLK Rising Edge to $\overline{CS}$ Falling Edge Wait Time	$t_{CSO}$				6		ns
Falling Edge of $\overline{CS}$ to Rising Edge of First SCLK Time	$t_{CSS}$				6		ns
DIN to SCLK Setup Time	$t_{DS}$				6		ns
DIN to SCLK Hold Time	$t_{DH}$				6		ns
SCLK Pulse-Width High	$t_{CH}$				6		ns
SCLK Pulse-Width Low	$t_{CL}$				6		ns
Last Rising Edge of SCLK to Rising Edge of $\overline{CS}$ or Clock to Load Enable Setup Time	$t_{CSH}$				6		ns
$\overline{CS}$ High Pulse Width	$t_{CSW}$				50		ns
Time Between Rising Edge of $\overline{CS}$ and the Next Rising Edge of SCLK	$t_{CS1}$				6		ns
SCLK Frequency	$f_{CLK}$					40	MHz
Rise Time	$t_R$				2.5		ns
Fall Time	$t_F$				2.5		ns
SCLK Falling Edge to Valid DOUT	$t_D$				12.5		ns

**Note 1:** The MAX2850 is production tested at  $T_A = +25^\circ C$ ; minimum/maximum limits at  $T_A = +25^\circ C$  are guaranteed by test, unless specified otherwise. Minimum/maximum limits at  $T_A = -25^\circ C$  and  $+85^\circ C$  are guaranteed by design and characterization. There is no power-on register settings self-reset; recommended register settings must be loaded after  $V_{CC}$  is applied.

**Note 2:** For optimal Rx and Tx quadrature accuracy over temperature, the user can utilize the Rx calibration and Tx calibration circuit to assist quadrature calibration.



Typical Operating Characteristics

( $V_{CC} = 2.8V$ ,  $f_{LO} = 5.35GHz$ ,  $f_{REF} = 40MHz$ ,  $\overline{CS} = high$ ,  $SCLK = DIN = low$ , RF BW = 20MHz, Tx output at 50Ω unbalanced output of balun,  $T_A = +25^{\circ}C$ , using the MAX2850 Evaluation Kit.)

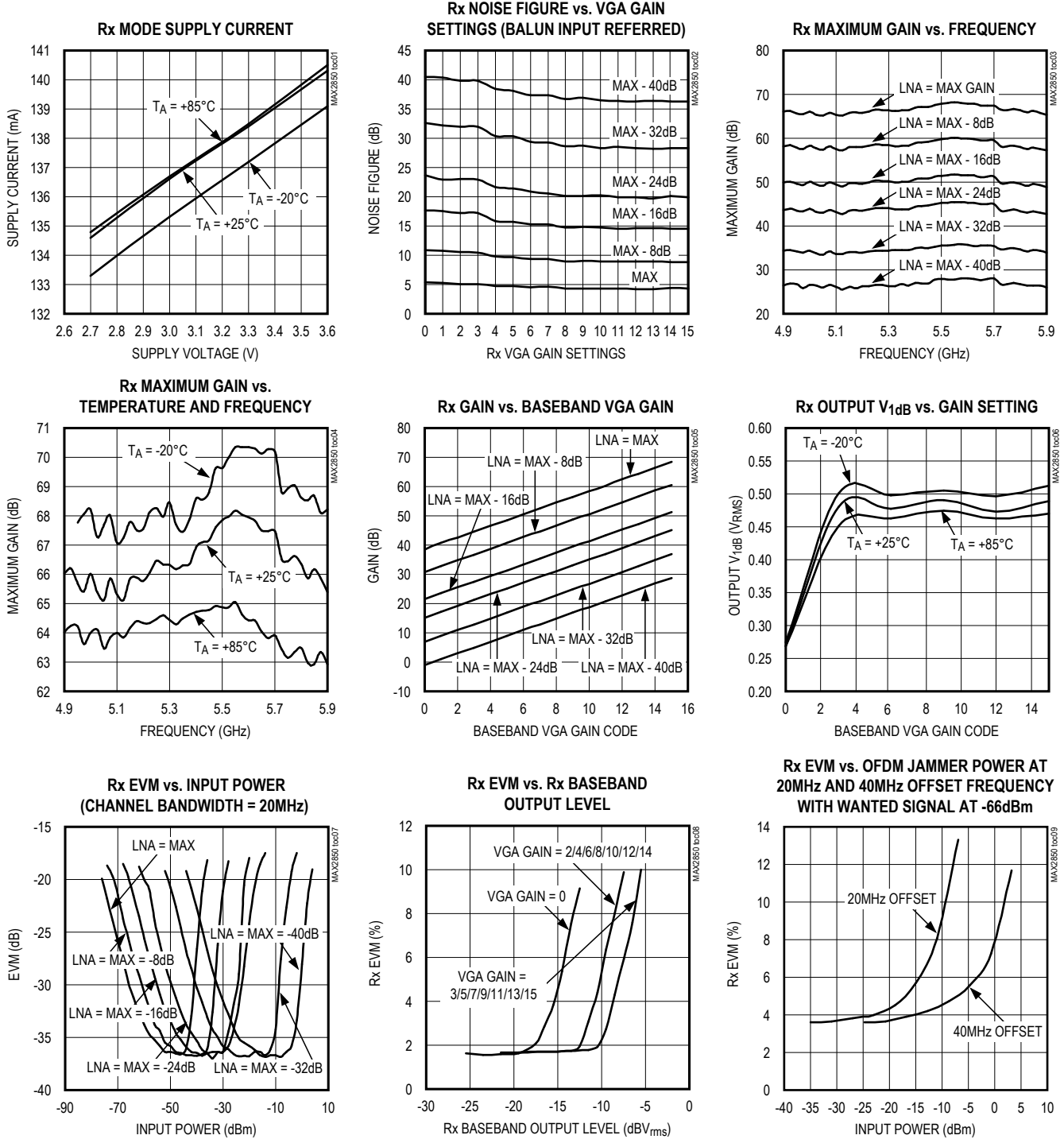

Typical Operating Characteristics (continued)

( $V_{CC} = 2.8V$ ,  $f_{LO} = 5.35GHz$ ,  $f_{REF} = 40MHz$ ,  $\overline{CS} = high$ ,  $SCLK = DIN = low$ , RF BW = 20MHz, Tx output at 50Ω unbalanced output of balun,  $T_A = +25^{\circ}C$ , using the MAX2850 Evaluation Kit.)

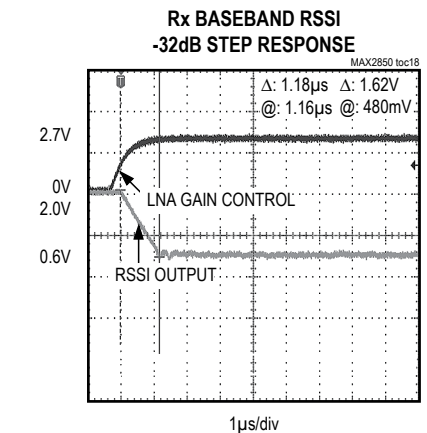
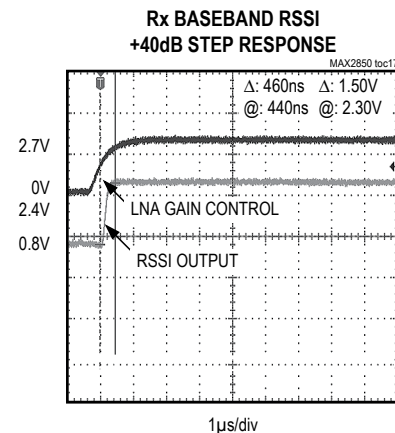
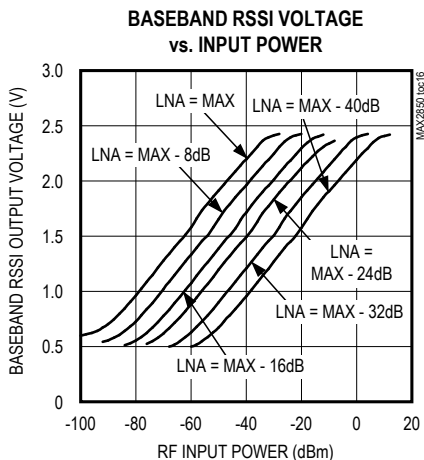
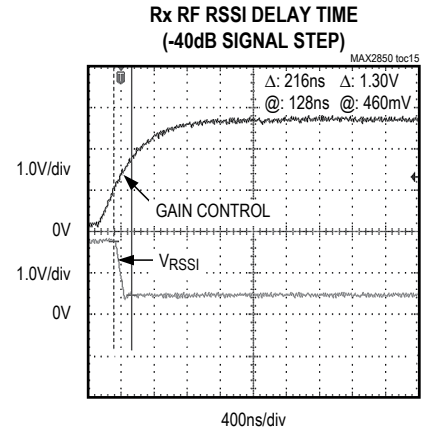
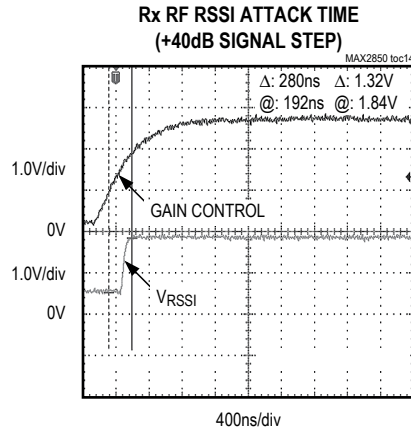
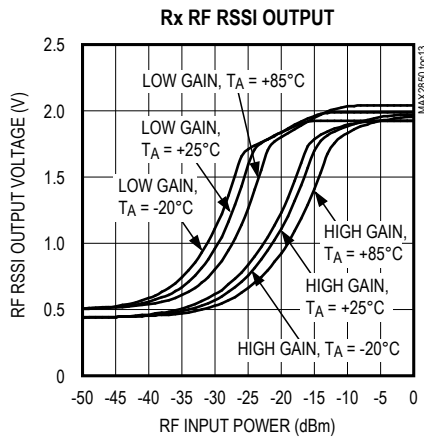
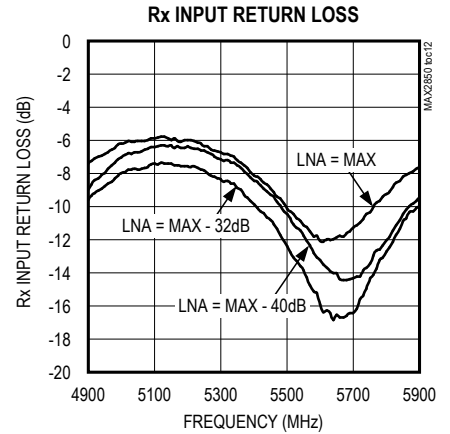
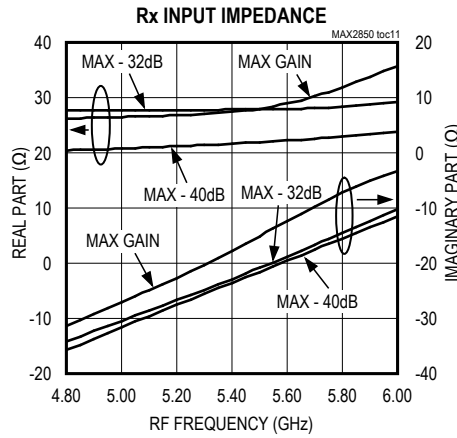
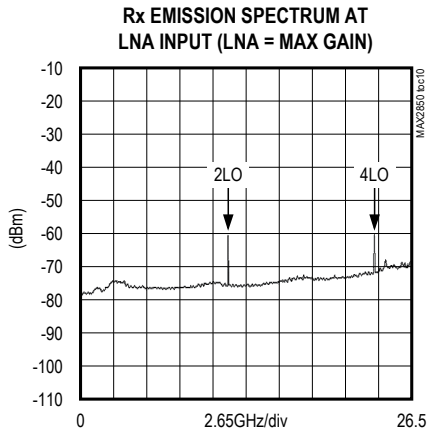

Typical Operating Characteristics (continued)

( $V_{CC} = 2.8V$ ,  $f_{LO} = 5.35GHz$ ,  $f_{REF} = 40MHz$ ,  $\overline{CS} = high$ ,  $SCLK = DIN = low$ , RF BW = 20MHz, Tx output at 50Ω unbalanced output of balun,  $T_A = +25^{\circ}C$ , using the MAX2850 Evaluation Kit.)

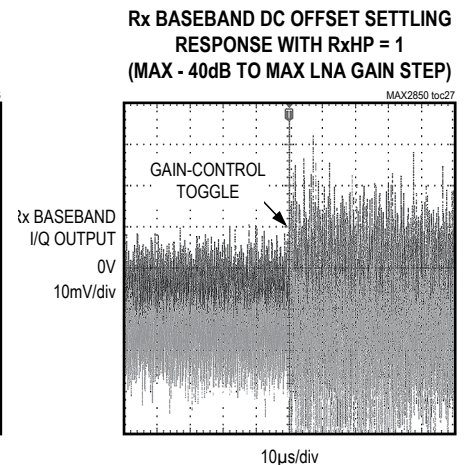
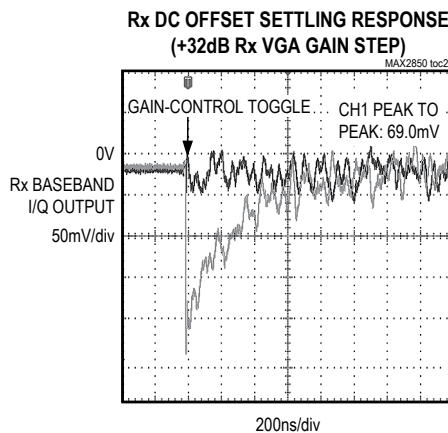
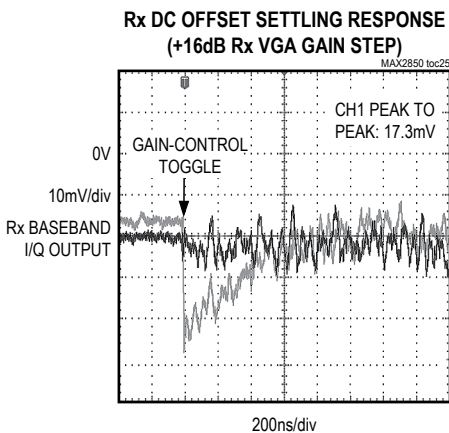
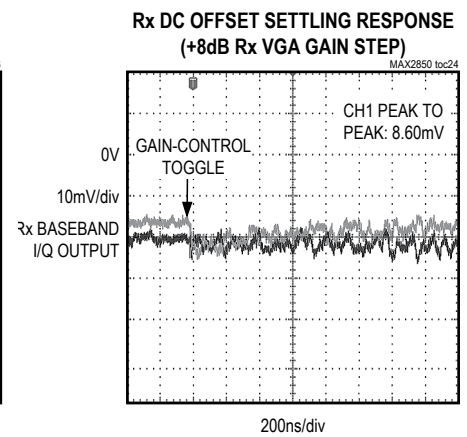
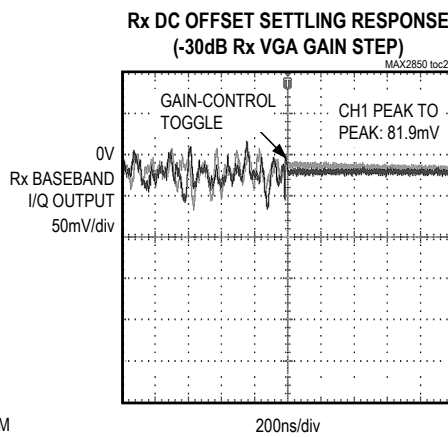
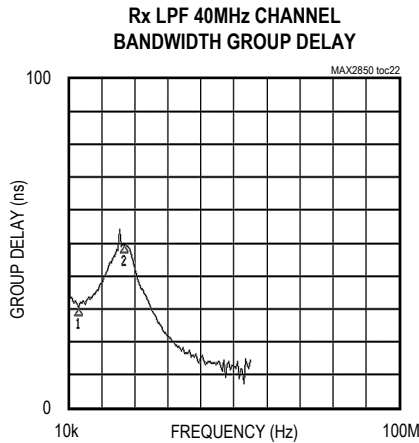
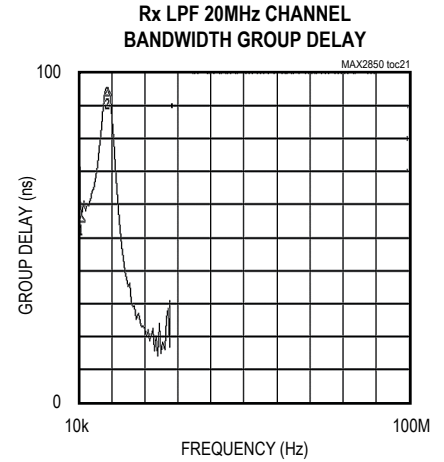
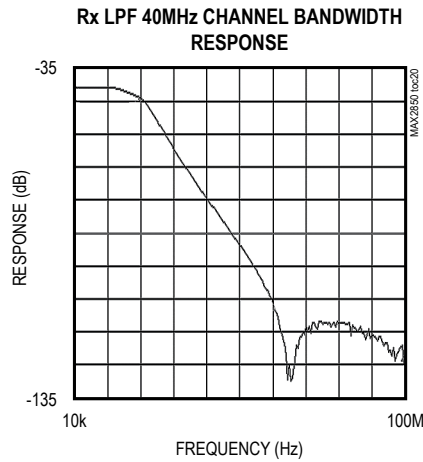
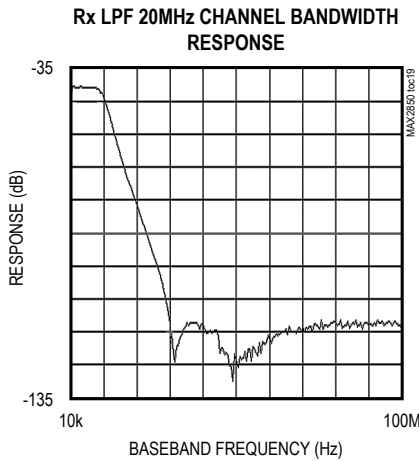

Typical Operating Characteristics (continued)

( $V_{CC} = 2.8V$ ,  $f_{LO} = 5.35GHz$ ,  $f_{REF} = 40MHz$ ,  $\overline{CS} = high$ ,  $SCLK = DIN = low$ , RF BW = 20MHz, Tx output at 50Ω unbalanced output of balun,  $T_A = +25^{\circ}C$ , using the MAX2850 Evaluation Kit.)

Rx BASEBAND DC OFFSET SETTLING RESPONSE WITH RxHP = 0 (MAX TO MAX - 40dB LNA GAIN STEP)

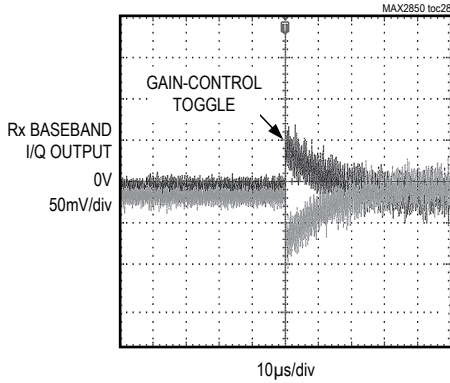

Rx BASEBAND DC OFFSET SETTLING RESPONSE WITH RxHP = 1 (MAX - 40dB TO MAX LNA GAIN STEP)

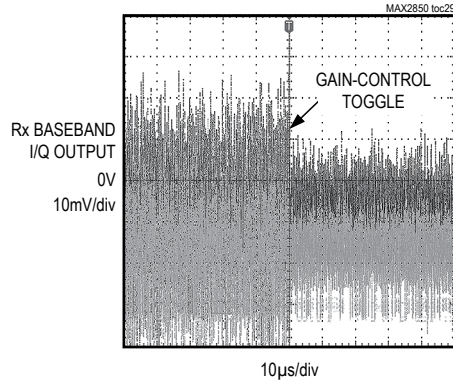

Rx BASEBAND DC OFFSET SETTLING RESPONSE WITH RxHP = 0 (MAX - 40dB TO MAX LNA GAIN STEP)

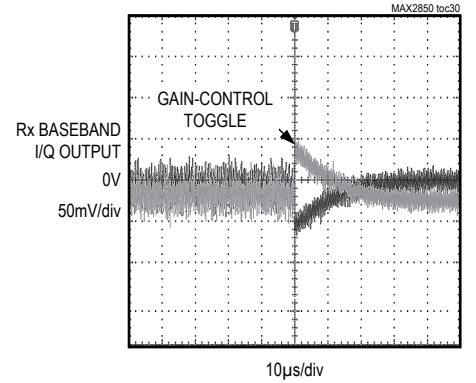

Rx BASEBAND VGA SETTLING RESPONSE (-30dB BASEBAND VGA GAIN STEP)

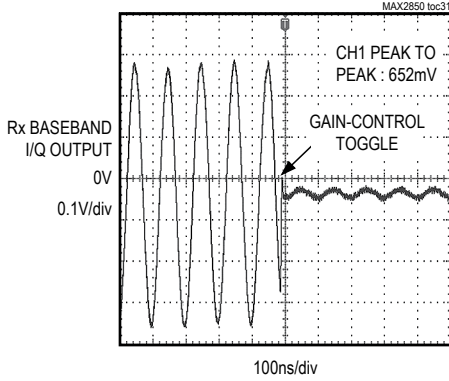

Rx BASEBAND VGA SETTLING RESPONSE (+4dB BASEBAND VGA GAIN STEP)

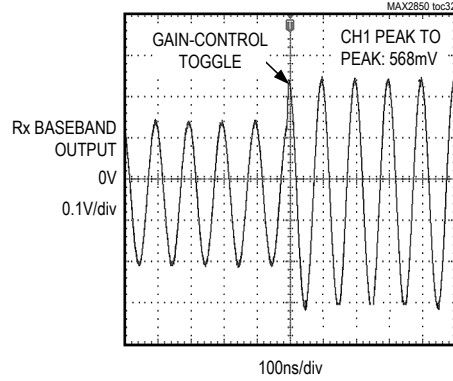

Rx BASEBAND VGA SETTLING RESPONSE (+16dB BASEBAND VGA GAIN STEP)

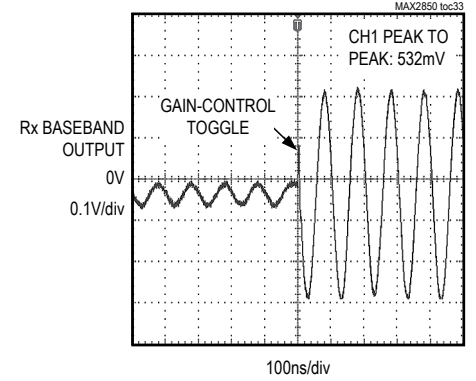

Rx BASEBAND VGA SETTLING RESPONSE (+30dB BASEBAND VGA GAIN STEP)

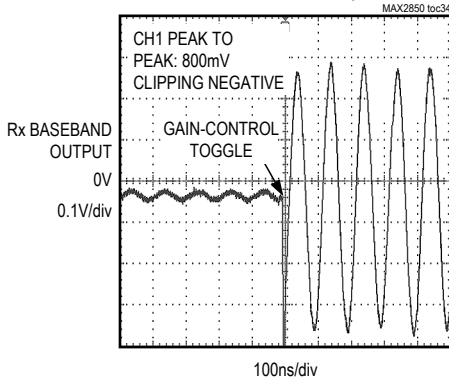

Rx LNA SETTLING RESPONSE (MAX TO MAX - 40dB GAIN STEP)

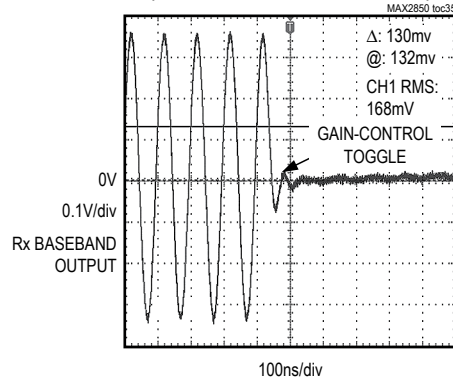

Rx LNA SETTLING RESPONSE (MAX - 8dB TO MAX GAIN STEP)

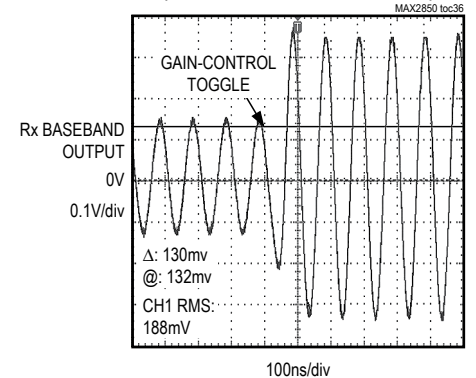

Typical Operating Characteristics (continued)

( $V_{CC} = 2.8V$ ,  $f_{LO} = 5.35GHz$ ,  $f_{REF} = 40MHz$ ,  $\overline{CS} = high$ ,  $SCLK = DIN = low$ , RF BW = 20MHz, Tx output at 50Ω unbalanced output of balun,  $T_A = +25^{\circ}C$ , using the MAX2850 Evaluation Kit.)

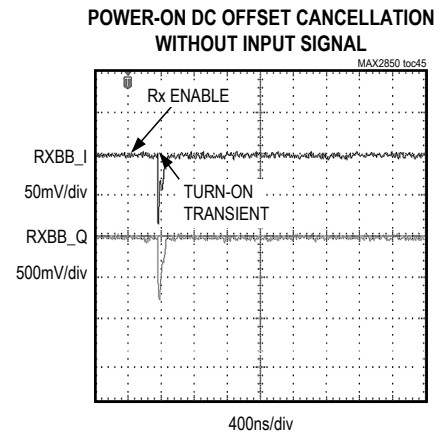
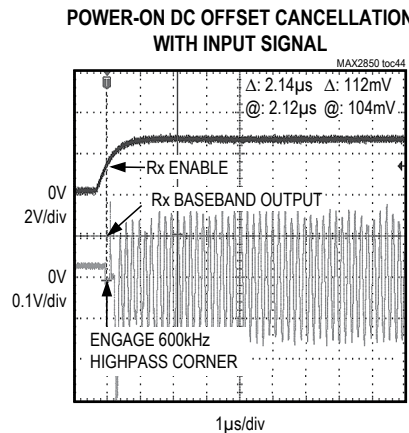
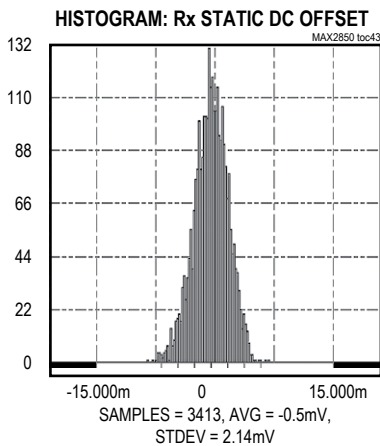
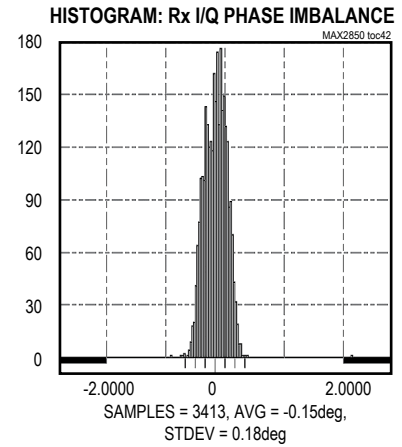
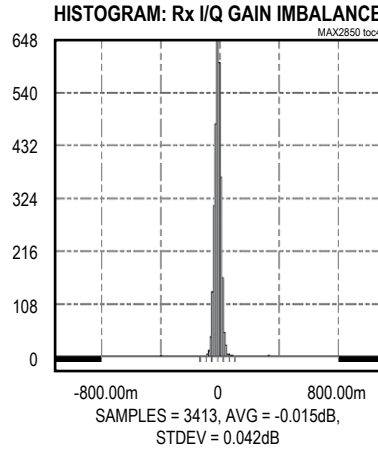
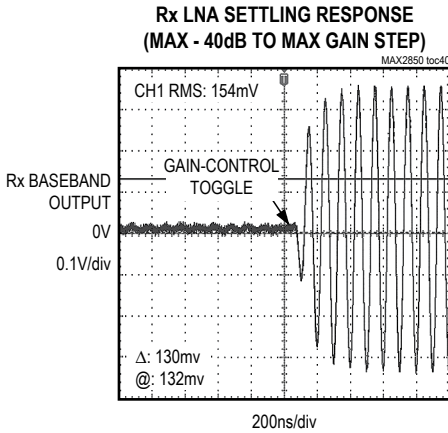
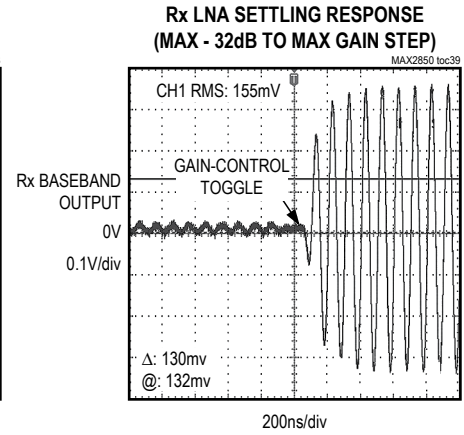
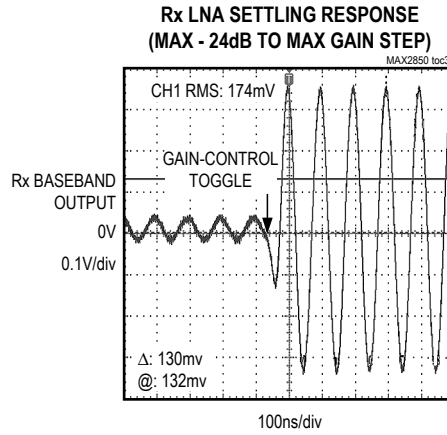
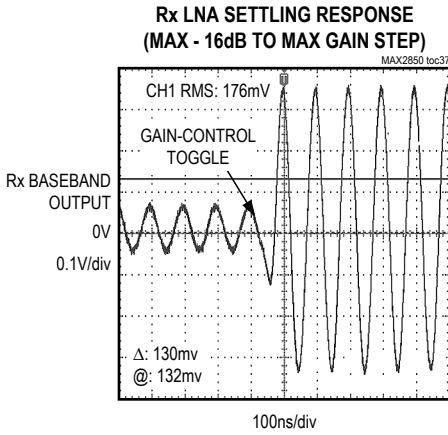

Typical Operating Characteristics (continued)

( $V_{CC} = 2.8V$ ,  $f_{LO} = 5.35GHz$ ,  $f_{REF} = 40MHz$ ,  $\overline{CS} = high$ ,  $SCLK = DIN = low$ , RF BW = 20MHz, Tx output at 50Ω unbalanced output of balun,  $T_A = +25^{\circ}C$ , using the MAX2850 Evaluation Kit.)

SINGLE Tx SUPPLY CURRENT vs. SUPPLY VOLTAGE

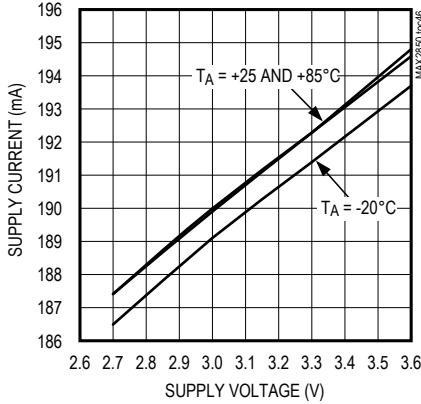

QUAD Tx SUPPLY CURRENT vs. SUPPLY VOLTAGE

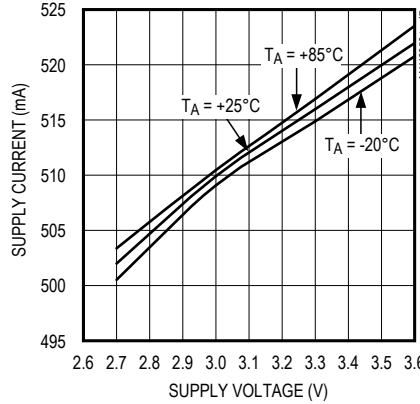

Tx BASEBAND RESPONSE

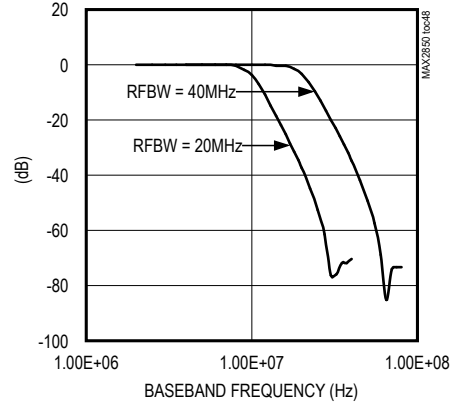

TX2 OUTPUT RETURN LOSS vs. FREQUENCY

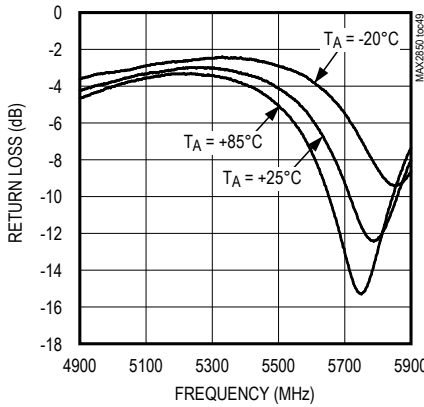

OUTPUT RETURN LOSS AT TA = +25°C vs. Tx CHANNELS

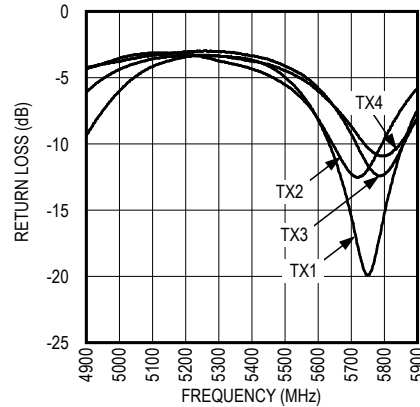

TX2 OUTPUT POWER AT MAXIMUM GAIN vs. RF FREQUENCY

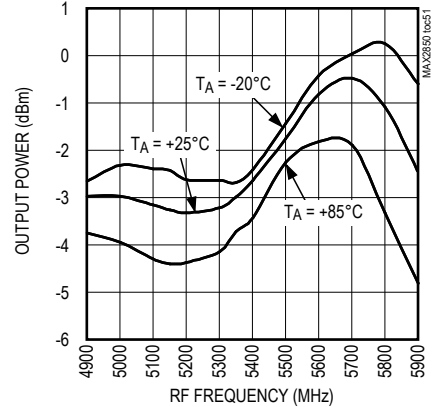

Tx OUTPUT POWER vs. Tx CHANNELS (GAIN = MAX - 3dB, 40MHz MODE, 100mVRMS BB INPUT)

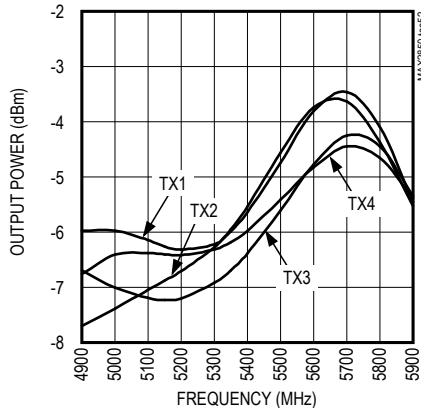

Tx OUTPUT POWER vs. GAIN SETTING

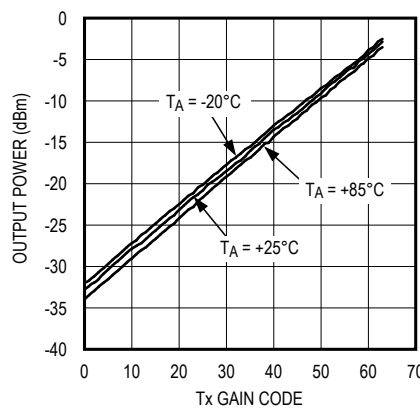

Tx GAIN STEP vs. GAIN SETTING

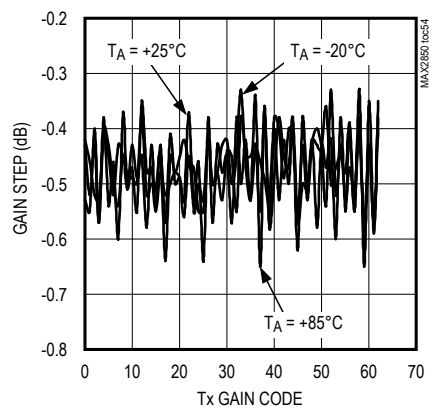

Typical Operating Characteristics (continued)

( $V_{CC} = 2.8V$ ,  $f_{LO} = 5.35GHz$ ,  $f_{REF} = 40MHz$ ,  $\overline{CS} = high$ ,  $SCLK = DIN = low$ , RF BW = 20MHz, Tx output at 50Ω unbalanced output of balun,  $T_A = +25^{\circ}C$ , using the MAX2850 Evaluation Kit.)

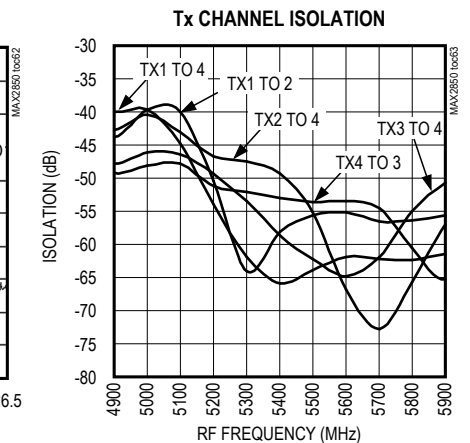
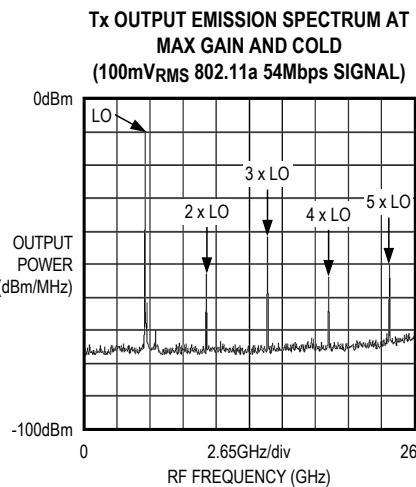
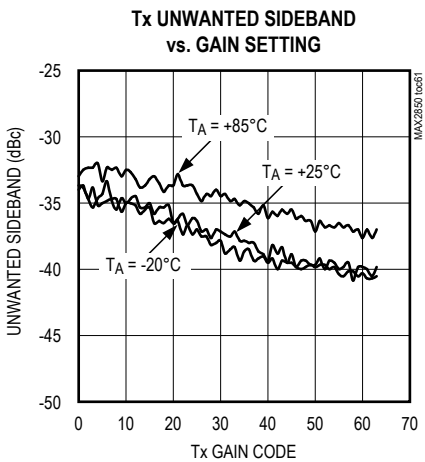
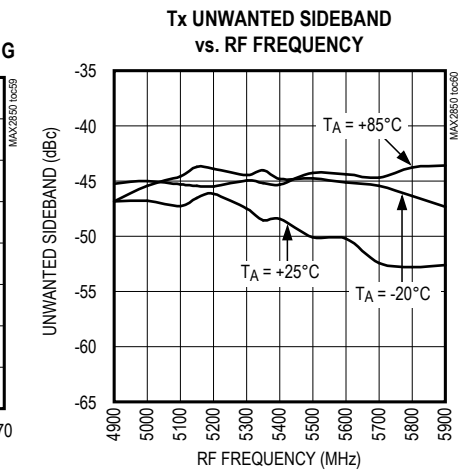
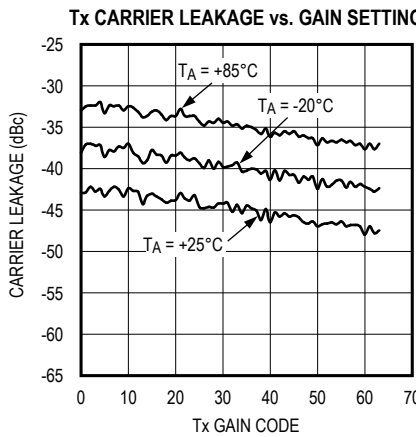
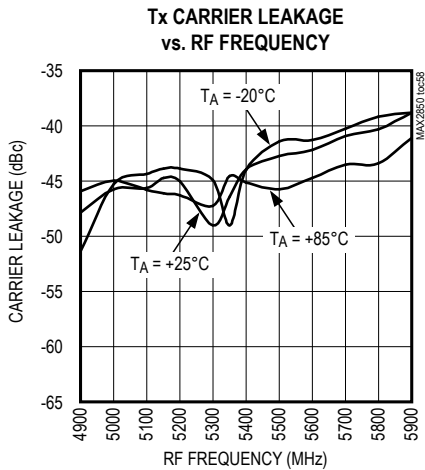
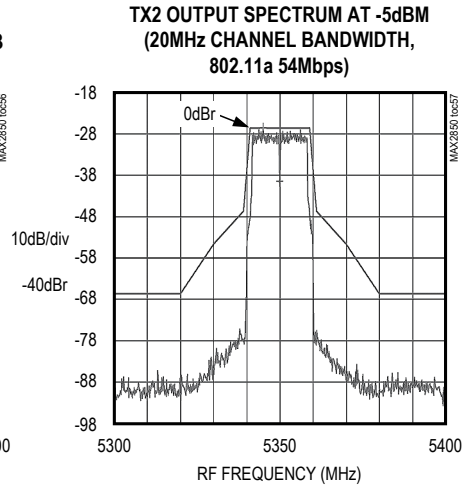
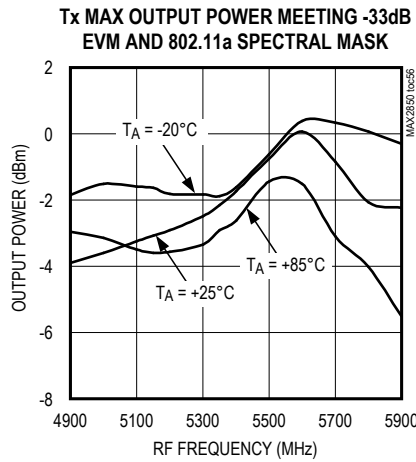
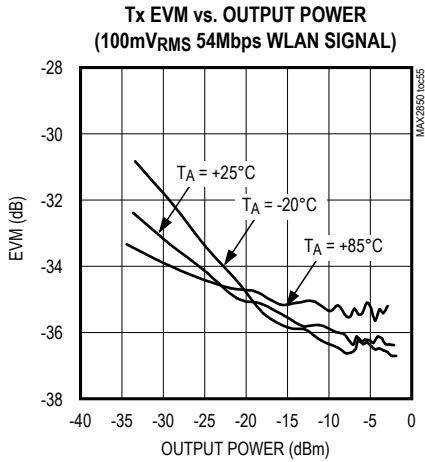

Typical Operating Characteristics (continued)

( $V_{CC} = 2.8V$ ,  $f_{LO} = 5.35GHz$ ,  $f_{REF} = 40MHz$ ,  $\overline{CS} = high$ ,  $SCLK = DIN = low$ , RF BW = 20MHz, Tx output at 50Ω unbalanced output of balun,  $T_A = +25^{\circ}C$ , using the MAX2850 Evaluation Kit.)

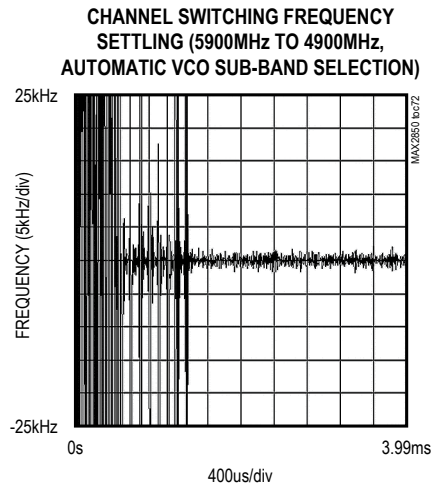
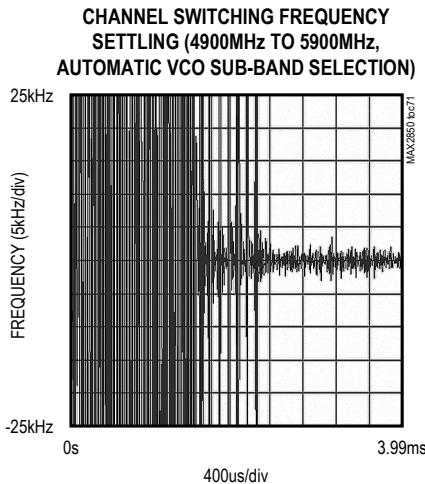
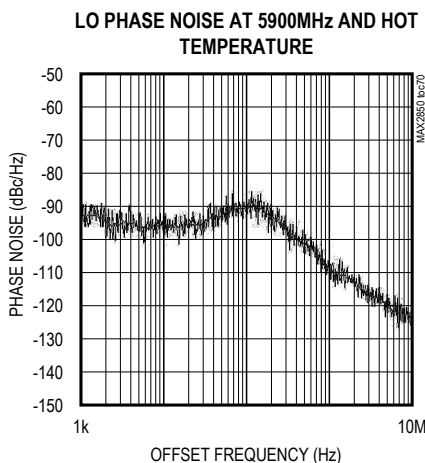
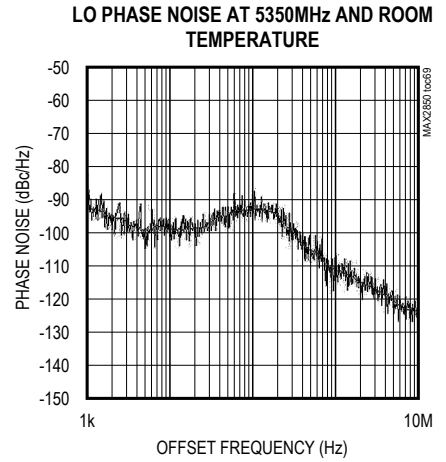
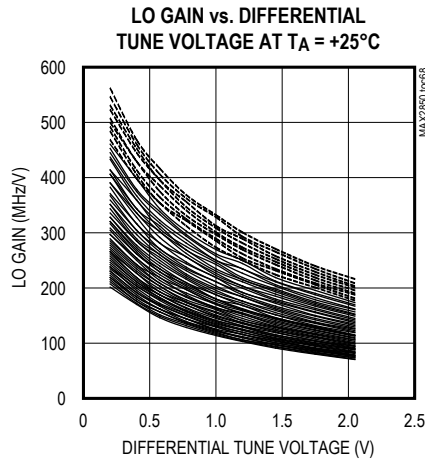
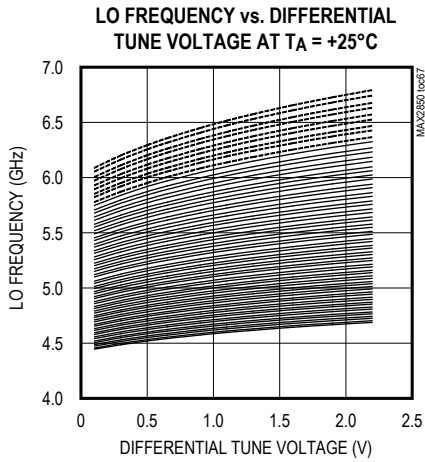
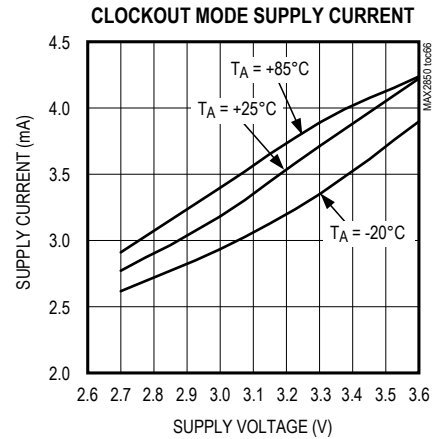
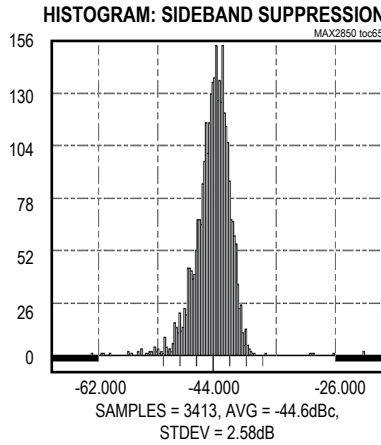
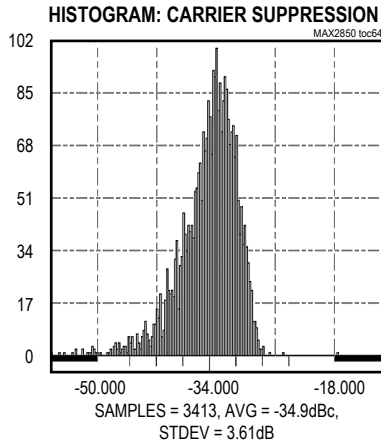



Typical Operating Characteristics (continued)

( $V_{CC} = 2.8V$ ,  $f_{LO} = 5.35GHz$ ,  $f_{REF} = 40MHz$ ,  $\overline{CS} = high$ ,  $SCLK = DIN = low$ ,  $RF\ BW = 20MHz$ , Tx output at  $50\Omega$  unbalanced output of balun,  $T_A = +25^\circ C$ , using the MAX2850 Evaluation Kit.)

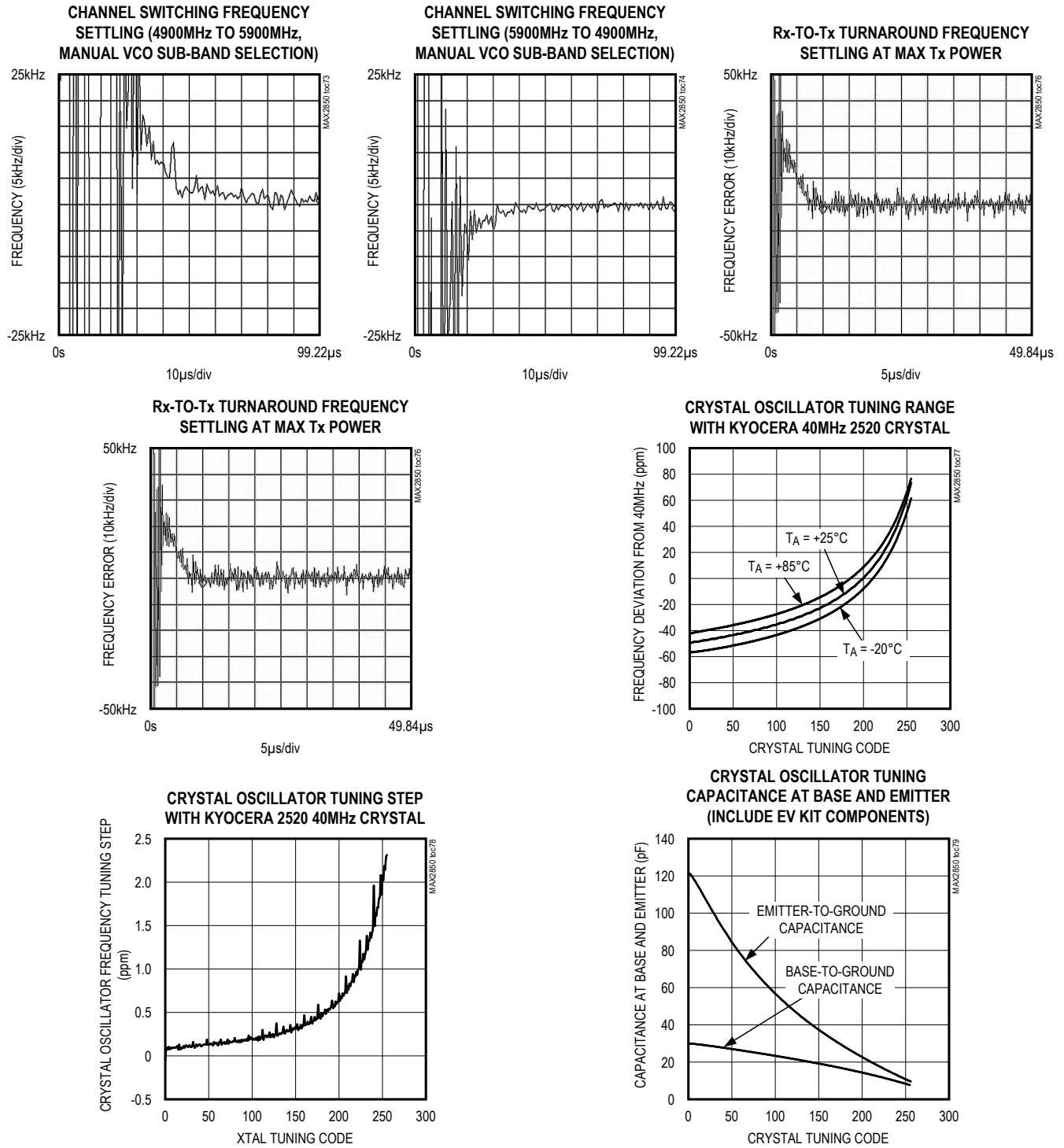

Pin Configuration

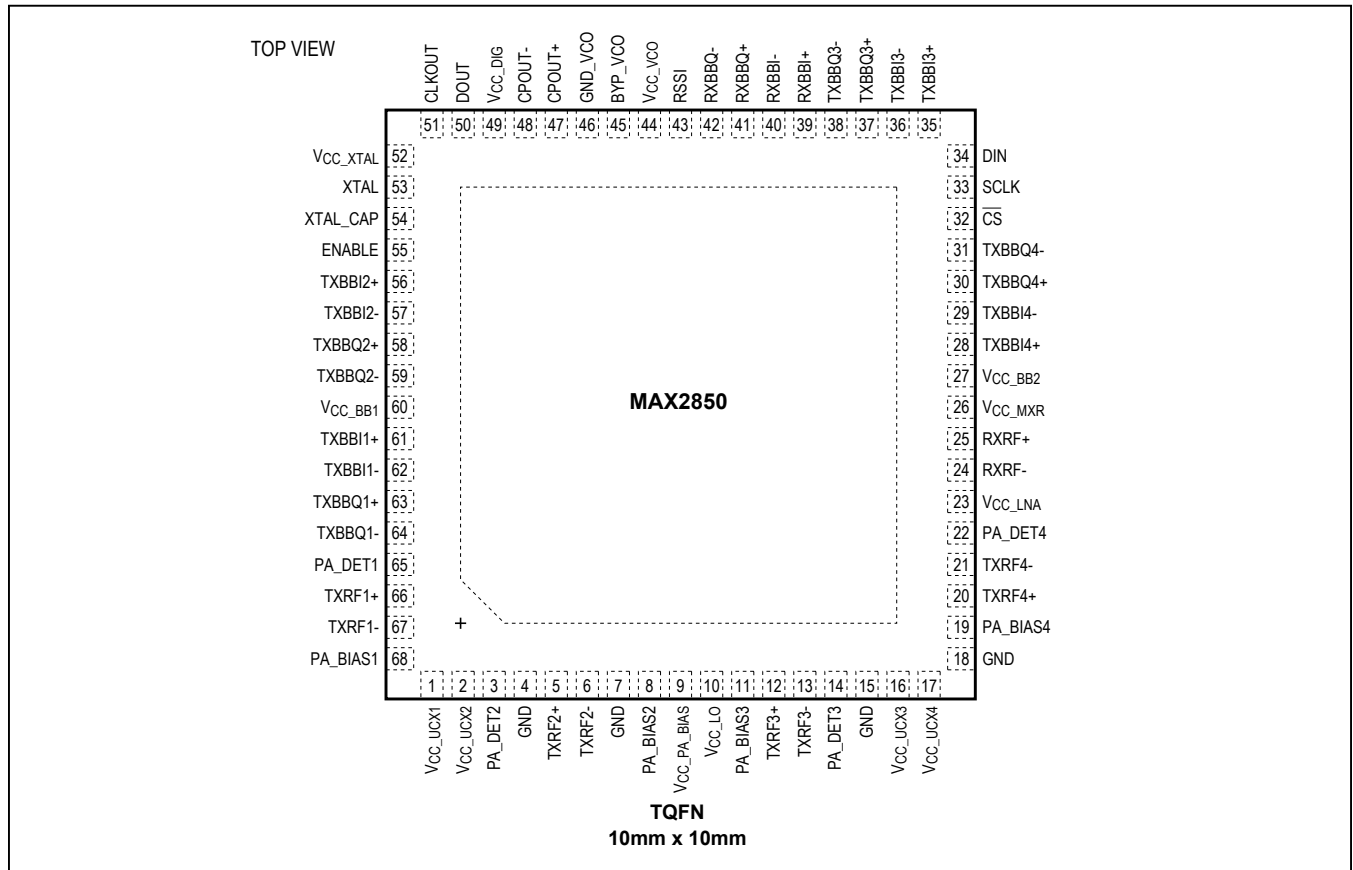

Pin Description

PIN	NAME	FUNCTION
1	V <sub>CC_UCX1</sub>	Transmitter 1 Upconverter Supply Voltage. Bypass with a capacitor as close as possible to the pin.
2	V <sub>CC_UCX2</sub>	Transmitter 2 Upconverter Supply Voltage. Bypass with a capacitor as close as possible to the pin.
3	PA_DET2	External Power-Amplifier Detector Mux Input 2
4	GND	Ground
5	TXRF2+	Transmitter 2 Differential Output. These pins are in open-collector configuration. These pins should be biased at the supply voltage with differential impedance terminated at 300Ω.
6	TXRF2-	
7	GND	Ground
8	PA_BIAS2	External Power-Amplifier Voltage Bias Output 2
9	V <sub>CC_PA_BIAS</sub>	External Power-Amplifier Voltage Bias and Detector Mux Supply Voltage. Bypass with a capacitor as close as possible to the pin.
10	V <sub>CC_LO</sub>	LO Generation Supply Voltage. Bypass with a capacitor as close as possible to the pin.
11	PA_BIAS3	External Power-Amplifier Voltage Bias Output 3
12	TXRF3+	Transmitter 3 Differential Output. These pins are in open-collector configuration. These pins should be biased at the supply voltage with differential impedance terminated at 300Ω.
13	TXRF3-	
14	PA_DET3	External Power Amplifier Detector Mux Input 3

## Pin Description (continued)

PIN	NAME	FUNCTION
15	GND	Ground
16	V <sub>CC_UCX3</sub>	Transmitter 3 Upconverter Supply Voltage. Bypass with a capacitor as close as possible to the pin.
17	V <sub>CC_UCX4</sub>	Transmitter 4 Upconverter Supply Voltage. Bypass with a capacitor as close as possible to the pin.
18	GND	Ground
19	PA_BIAS4	External Power-Amplifier Voltage Bias Output 4
20	TXRF4+	Transmitter 4 Differential Output. These pins are in open-collector configuration. These pins should be biased at the supply voltage with differential impedance terminated at 300Ω.
21	TXRF4-	
22	PA_DET4	External Power-Amplifier Detector Mux Input 4
23	V <sub>CC_LNA</sub>	Receiver LNA Supply Voltage. Bypass with a capacitor as close as possible to the pin.
24	RXRF-	Receiver LNA Differential Input. Input is DC-coupled and biased internally at 1.2V.
25	RXRF+	
26	V <sub>CC_MXR</sub>	Receiver Downconverter Supply Voltage. Bypass with a capacitor as close as possible to the pin.
27	V <sub>CC_BB2</sub>	Receiver Baseband Supply Voltage 2. Bypass with a capacitor as close as possible to the pin.
28	TXBBI4+	Transmitter 4 Baseband I-Channel Differential Input
29	TXBBI4-	
30	TXBBQ4+	Transmitter 4 Baseband Q-Channel Differential Input
31	TXBBQ4-	
32	$\overline{\text{CS}}$	Chip-Select Logic Input of 4-Wire Serial Interface
33	SCLK	Serial-Clock Logic Input of 4-Wire Serial Interface
34	DIN	Data Logic Input of 4-Wire Serial Interface
35	TXBBI3+	Transmitter 3 Baseband I-Channel Differential Input
36	TXBBI3-	
37	TXBBQ3+	Transmitter 3 Baseband Q-Channel Differential Input
38	TXBBQ3-	
39	RXBBI+	Receiver Baseband I-Channel Differential Output
40	RXBBI-	
41	RXBBQ+	Receiver Baseband Q-Channel Differential Output
42	RXBBQ-	
43	RSSI	Receiver Signal-Strength Indicator Output
44	V <sub>CC_VCO</sub>	VCO Supply Voltage. Bypass with a capacitor as close as possible to the pin.
45	BYP_VCO	On-Chip VCO Regulator Output Bypass. Bypass with an external 1μF capacitor to GND_VCO with minimum PCB trace. Do not connect other circuitry to this pin.
46	GND_VCO	VCO Ground
47	CPOUT+	Differential Charge-Pump Output. Connect the frequency synthesizer's loop filter between CPOUT+ and CPOUT- (see the <i>Typical Operating Circuit</i> ).
48	CPOUT-	
49	V <sub>CC_DIG</sub>	Digital Block Supply Voltage. Bypass with a capacitor as close as possible to the pin.
50	DOUT	Data Logic Output of 4-Wire Serial Interface
51	CLKOUT	Reference Clock Buffer Output
52	V <sub>CC_XTAL</sub>	Crystal Oscillator Supply Voltage. Bypass with a capacitor as close as possible to the pin.
53	XTAL	Crystal Oscillator Base Input. AC-couple crystal unit to this pin.
54	XTAL_CAP	Crystal Oscillator Emitter Node
55	ENABLE	Enable Logic Input

## Pin Description (continued)

PIN	NAME	FUNCTION
56	TXBBI2+	Transmitter 2 Baseband I-Channel Differential Input
57	TXBBI2-	
58	TXBBQ2+	Transmitter 2 Baseband Q-Channel Differential Input
59	TXBBQ2-	
60	V <sub>CC_BB1</sub>	Receiver Baseband Supply Voltage 1. Bypass with a capacitor as close as possible to the pin.
61	TXBBI1+	Transmitter 1 Baseband I-Channel Differential Input
62	TXBBI1-	
63	TXBBQ1+	Transmitter 1 Baseband Q-Channel Differential Input
64	TXBBQ1-	
65	PA_DET1	External Power-Amplifier Detector Mux Input 1
66	TXRF1+	Transmitter 1 Differential Output. These pins are in open-collector configuration. These pins should be biased at the supply voltage with differential impedance terminated at 300Ω.
67	TXRF1-	
68	PA_BIAS1	External Power-Amplifier Voltage Bias Output 1
—	EP	Exposed Pad. Connect to the ground plane with multiple vias for proper operation and heat dissipation. Do not share with any other pin grounds and bypass capacitors' ground.

**Table 1. Operating Modes**

MODE	MODE CONTROL LOGIC INPUTS		CIRCUIT BLOCK STATES				
	ENABLE PIN	SPI MAIN ADDRESS 0, D4:D2	Rx PATH	Tx PATH (Note 4)	LO PATH	CLKOUT (Note 5)	Calibration Sections On
<b>SHUTDOWN</b>	0	XXX	Off	Off	Off	Off	None
<b>CLKOUT</b>	1	000	Off	Off	Off	On	None
<b>STANDBY</b>	1	001	Off	Off	On	On	None
<b>Rx</b>	1	010	On	Off	On	On	None
<b>Tx</b>	1	011	Off	On	On	On	None
<b>Tx CALIBRATION</b>	1	100	Off	On	On	On	AM detector + Rx I/Q buffers
<b>RF LOOPBACK</b>	1	101	On (except LNA)	On	On	On	RF loopback
<b>BASEBAND LOOPBACK</b>	1	11X	On (except RXRF)	Off	On	On	Tx 4 baseband buffer

**Note 4:** PA\_BIAS pins may be kept active in nontransmit mode(s) by SPI programming.

**Note 5:** CLKOUT signal is active independent of SPI, and is only dependent on the ENABLE pin.

## Detailed Description

### Modes of Operation

The modes of operation for the MAX2850 are shutdown, clockout, standby, receive, transmit, transmitter calibration, RF loopback, and baseband loopback. See Table 1 for a summary of the modes of operation. The logic input

pin ENABLE (pin 55) and SPI Main address 0 D4:D2 control the various modes.

### Shutdown Mode

The MAX2850 features a low-power shutdown mode. All circuit blocks are powered down, except the 4-wire serial bus and its internal programmable registers.

**Clockout Mode**

In clockout mode, only the crystal oscillator signal is active at the CLKOUT pin. The rest of the transceiver is powered down.

**Standby Mode**

In standby mode, PLL, VCO, and LO generation are on. Tx or Rx modes can be quickly enabled from this mode. Other blocks may be selectively enabled in this mode.

**Receive (Rx) Mode**

In receive mode, all Rx circuit blocks are powered on and active. Antenna signal is applied; RF is down-converted, filtered, and buffered at Rx baseband I and Q outputs.

**Transmit (Tx) Mode**

In transmit mode, all Tx circuit blocks are powered on and active. The external PA can be powered on through the PA\_BIAS pins after a programmable delay.

**Transmit Calibration**

In transmit calibration mode, all Tx circuit blocks are powered on and active. The AM detector and receiver I/Q channel buffers are also on. Output signals are routed to Rx baseband I and Q outputs.

The AM detector multiplies the Tx RF output signal with itself. The self-mixing product of the wanted sideband becomes DC voltage and is filtered on-chip. The mixing product between wanted sideband and the carrier leakage forms  $F_{\text{tone}}$  at Rx baseband output. The mixing product between the wanted sideband and the unwanted sideband forms  $2F_{\text{tone}}$  at Rx baseband output.

As Tx RF output is self-mixed at the AM detector, the AM detector output responds differently to different gain settings and power levels. When Tx RF output power changes by 1dB through Tx gain control, the AM detector output changes by 2dB as both the wanted sideband and carrier leakage (or unwanted sideband) change by 1dB. When Tx RF output carrier leakage (or unwanted sideband) changes by 1dB while the wanted sideband output power is constant, the AM detector output changes by 1dB only.

**RF Loopback**

In RF loopback mode, part of the Rx and Tx circuit blocks except the LNA are powered on and active. The transmitter 4 I/Q input signal is upconverted to RF, and the output of the transmitter is fed to the receiver down-converter input. Output signals are delivered to receiver 4 baseband I/Q outputs. The I/Q lowpass filters in the transmitter signal path are bypassed.

*MICROWIRE is a trademark of National Semiconductor Corp.*

**Baseband Loopback**

In baseband loopback mode, part of the Rx and Tx baseband circuit blocks are powered and active. The transmitter 4 I/Q input signal is routed to receiver lowpass filter input. Output signals are delivered to receiver 4 baseband I/Q outputs.

**Power-On Sequence**

Set the ENABLE pin to  $V_{CC}$  for 2ms to start the crystal oscillator. Program all SPI addresses according to recommended values. Set SPI Main address 0 D4:D2 from 000 to 001 to engage standby mode. To lock the LO frequency, the user can set SPI in order of Main address 15, Main address 16, and then Main address 17 to trigger VCO sub-band autoacquisition; the acquisition will take 2ms. After the LO frequency is locked, set SPI Main address 0 D4:D2 = 010 and 011 for Rx and Tx operating modes, respectively. Before engaging Rx mode, set Main address 5 D1 = 1 to allow fast DC offset settling. After engaging Rx mode and Rx baseband DC offset settles, the user can set Main address 5 D1 = 0 to complete Rx DC offset cancellation.

**Programmable Registers and 4-Wire SPI Interface**

The MAX2850 includes 60 programmable 16-bit registers. The most significant bit (MSB) is the read/write selection bit (R/W in Figure 1). The next 5 bits are register address (A4:A0 in Figure 1). The 10 least significant bits (LSBs) are register data (D9:D0 in Figure 1). Register data is loaded through the 4-wire SPI/MICROWIRE™-compatible serial interface. MSB of data at the DIN pin is shifted in first and is framed by  $\overline{CS}$ . When  $\overline{CS}$  is low, the clock is active, and input data is shifted at the rising edge of the clock at SCLK pin. At the  $\overline{CS}$  rising edge, the 10-bit data bits are latched into the register selected by address bits. See Figure 1. To support more than a 32-register address using a 5-bit wide address word, the bit 0 of address 0 is used to select whether the 5-bit address word is applied to the main address or local address. The register values are preserved in shutdown mode as long as the power-supply voltage is maintained. There is no power-on SPI register self-reset functionality in the MAX2850, so the user must program all register values after power-up. During the read mode, register data selected by address bits is shifted out to the DOUT pin at the falling edges of the clock.

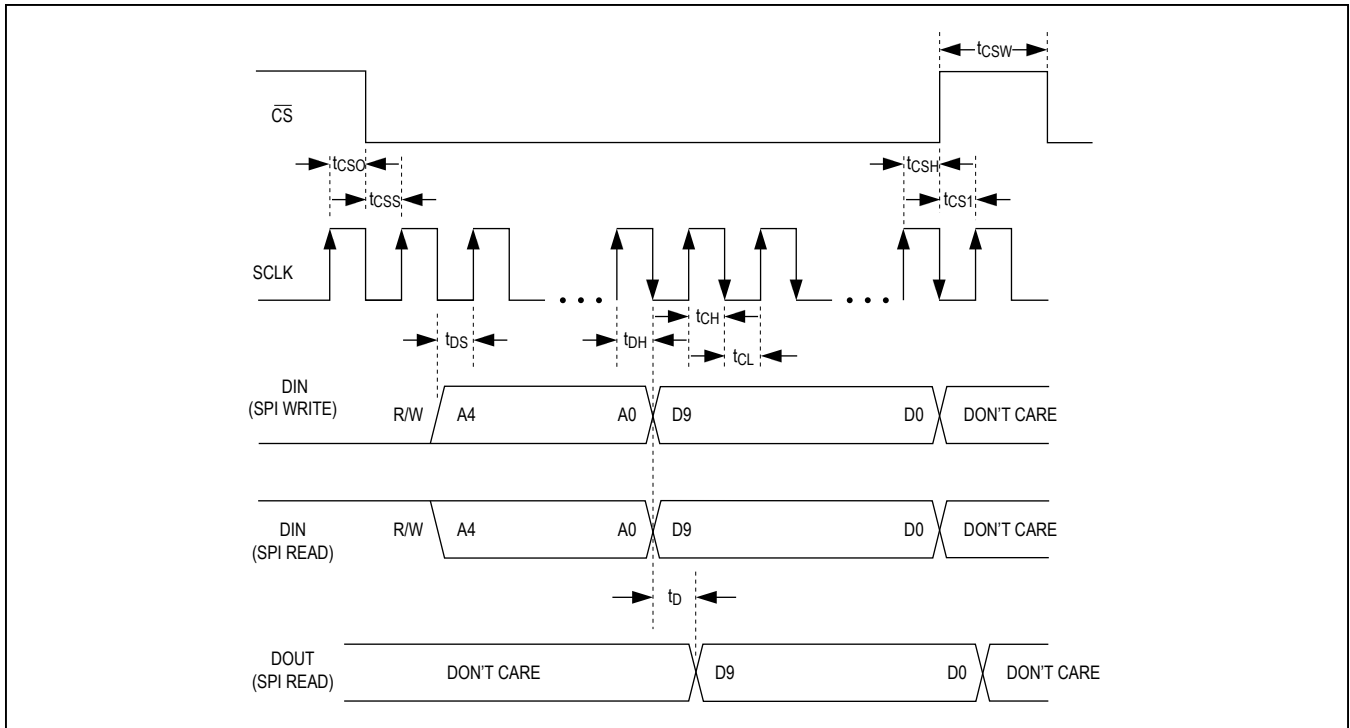

Figure 1. 4-Wire SPI Serial-Interface Timing Diagram

### SPI Register Definition

(All values in the register summary table are typical numbers. The MAX2850 SPI does not have a power-on-default self-reset feature; the user must program all SPI addresses for normal operation. Prior to use of any untested settings, contact the factory.)

Table 2. MAX2850 Register Summary

REGISTER	READ/WRITE AND ADDRESS			DATA										
	Main0_D0	A4:A0	WRITE (W)/ READ (R)	D9	D8	D7	D6	D5	D4	D3	D2	D1	D0	
Main0	0	00000	W/R	RESERVED	E_TX<4:1>					MODE<2:0>			RFBW	M/L_SEL
			Default	0	1	1	1	1	0	0	0	1	0	
Main1	0	00001	W/R	RESERVED	RESERVED	LNA_GAIN<2:0>			RX_VGA<4:0>					
			Default	0	0	1	1	1	1	1	1	1	1	
Main2	0	00010	W/R	RESERVED	RESERVED	RESERVED	LNA_BAND<1:0>		RESERVED	RESERVED	RESERVED	RESERVED	RESERVED	
			Default	0	1	1	0	1	0	0	0	0	0	
Main3	0	00011	W	RESERVED	RESERVED	TS_EN	TS_TRIG	RESERVED	RESERVED	RESERVED	RESERVED	RESERVED	RESERVED	
			R	RESERVED	RESERVED			RESERVED	TS_READ<4:0>					
			Default	0	0	0	0	0	0	0	0	0	0	0

Table 2. MAX2850 Register Summary (continued)

REGISTER	READ/WRITE AND ADDRESS			DATA									
	Main0_D0	A4:A0	WRITE (W)/ READ (R)	D9	D8	D7	D6	D5	D4	D3	D2	D1	D0
Main4	0	00100	Reserved	1	1	0	0	0	1	1	1	0	0
Main5	0	00101	W/R	RESERVED	RSSI_MUX_SEL<2:0>		RESERVED	RESERVED	RESERVED	RESERVED	RXHP	RESERVED	
			Default	0	0	0	0	0	0	0	0	0	0
Main6	0	00110	Reserved	1	1	1	1	1	0	1	0	0	0
Main7	0	00111	Reserved	0	0	0	0	1	0	0	1	0	0
Main8	0	01000	W/R	0	0	0	0	0	0	0	0	0	0
Main9	0	01001	W/R	TX_GAIN<5:0>					TX_GAIN_PROG_SEL<4:1>				
			Default	0	0	0	0	0	0	1	1	1	1
Main10	0	01010	Reserved	0	0	0	0	0	0	0	0	0	0
Main11	0	01011	W/R	RESERVED	RESERVED	RESERVED	RESERVED	RESERVED	RESERVED	E_TX_AMD<1:0>		PA_DET_SEL<1:0>	
			Default	0	0	0	1	1	0	0	0	0	0
Main13	0	01101	Reserved	0	0	0	0	0	0	0	0	0	0
Main14	0	01110	W/R	RESERVED	RESERVED	RESERVED	RESERVED	RESERVED	RESERVED	RESERVED	RESERVED	DOUT_SEL	RESERVED
			Default	0	1	0	1	1	0	0	0	0	0
Main15	0	01111	W/R	VAS_TRIG_EN	RESERVED		SYN_CONFIG_N<6:0>						
			Default	1	0	0	1	0	0	0	0	0	1
Main16	0	10000	W/R	SYN_CONFIG_F<19:10>									
			Default	1	1	1	0	0	0	0	0	0	0
Main17	0	10001	W/R	SYN_CONFIG_F<9:0>									
			Default	0	0	0	0	0	0	0	0	0	0
Main18	0	10010	W/R	RESERVED	RESERVED	XTAL_TUNE<7:0>							
			Default	0	0	1	0	0	0	0	0	0	0
Main19	0	10011	W/R	RESERVED	RESERVED	VAS_RELOCK_SEL	VAS_MODE	VAS_SPI<5:0>					
			Read	VAS_ADC<2:0>				VCO_BAND<5:0>					
			Default	0	0	0	1	0	1	1	1	1	1
Main20	0	10100	Reserved	0	1	1	1	1	0	1	0	1	0
Main21	0	10101	Read	RESERVED	RESERVED	DIE_ID<2:0>		RESERVED	RESERVED	RESERVED	RESERVED	RESERVED	
			Default	0	0	1	0	1	1	1	1	1	1
Main22	0	10110	Reserved	0	1	1	0	1	1	1	0	0	0
Main23	0	10111	Reserved	0	0	0	1	1	0	0	1	0	1
Main24	0	11000	Reserved	1	0	0	1	0	0	1	1	1	1
Main25	0	11001	Reserved	1	1	1	0	1	0	1	0	0	0
Main26	0	11010	Reserved	0	0	0	0	0	1	0	1	0	1
Main27	0	11011	W/R	DIE_ID_READ	RESERVED	RESERVED	RESERVED	VAS_VCO_READ	RESERVED	RESERVED	RESERVED	RESERVED	RESERVED
			Default	0	1	1	0	0	0	0	0	0	0
Main28	0	11100	W/R	RESERVED	RESERVED	RESERVED	RESERVED	RESERVED	RESERVED	PA_BIAS_DLY<3:0>			
			Default	0	0	0	1	1	0	0	0	0	1

Table 2. MAX2850 Register Summary (continued)

REGISTER	READ/WRITE AND ADDRESS			DATA									
	Main0_D0	A4:A0	WRITE (W)/ READ (R)	D9	D8	D7	D6	D5	D4	D3	D2	D1	D0
Main29	0	11101	Reserved	0	0	0	0	0	0	0	0	0	0
Main30	0	11110	Reserved	0	0	0	0	0	0	0	0	0	0
Main31	0	11111	Reserved	0	0	0	0	0	0	0	0	0	0
Local1	1	00001	Reserved	0	0	0	0	0	0	0	0	0	0
Local2	1	00010	Reserved	0	0	0	0	0	0	0	0	0	0
Local3	1	00011	Reserved	0	0	0	0	0	0	0	0	0	0
Local4	1	00100	Reserved	1	1	1	0	0	0	0	0	0	0
Local5	1	00101	Reserved	0	0	0	0	0	0	0	0	0	0
Local6	1	00110	Reserved	0	0	0	0	0	0	0	0	0	0
Local7	1	00111	Reserved	0	0	0	0	0	0	0	0	0	0
Local8	1	01000	Reserved	0	1	1	0	1	0	1	0	1	0
Local9	1	01001	Reserved	0	1	0	0	0	1	0	1	0	0
Local10	1	01010	Reserved	1	1	0	1	0	1	0	1	0	0
Local11	1	01011	Reserved	0	0	0	1	1	1	0	0	1	1
Local12	1	01100	Reserved	0	0	0	0	0	0	0	0	0	0
Local13	1	01101	Reserved	0	0	0	0	0	0	0	0	0	0
Local14	1	01110	Reserved	0	0	0	0	0	0	0	0	0	0
Local15	1	01111	Reserved	0	0	0	0	0	0	0	0	0	0
Local16	1	10000	Reserved	0	0	0	0	0	0	0	0	0	0
Local17	1	10001	Reserved	0	0	0	0	0	0	0	0	0	0
Local18	1	10010	Reserved	0	0	0	0	0	0	0	0	0	0
Local19	1	10011	Reserved	0	0	0	0	0	0	0	0	0	0
Local20	1	10100	Reserved	0	0	0	0	0	0	0	0	0	0
Local21	1	10101	Reserved	0	0	0	0	0	0	0	0	0	0
Local22	1	10110	Reserved	0	0	0	0	0	0	0	0	0	0
Local23	1	10111	Reserved	0	0	0	0	0	0	0	0	0	0
Local24	1	11000	Reserved	0	0	1	1	0	0	0	1	0	0
Local25	1	11001	Reserved	0	1	0	0	1	0	1	0	1	1
Local26	1	11010	Reserved	0	1	0	1	1	0	0	1	0	1
Local27	1	11011	W/R	RESERVED	RESERVED	RESERVED	RESERVED	RESERVED	RESERVED	RESERVED	TX_AMD_BB_GAIN	TX_AMD_RF_GAIN <1:0>	
			Default	0	0	0	0	0	0	0	0	0	0
Local28	1	11100	Reserved	0	0	0	0	0	0	0	1	0	0
Local31	1	11111	Reserved	0	0	0	0	0	0	0	0	0	0



**Table 3. Main Address 0: (A4:A0 = 00000)**

BIT NAME	BIT LOCATION (D0 = LSB)	DESCRIPTION
RESERVED	D9	Reserved bits; set to default
E_TX<4:1>	D8:D5	<b>Tx MIMO Channel Select</b> Select Tx channels independently. 0 = Not select 1 = Select in Tx, Tx calibration, or RF loopback modes 1111 = Default
MODE<2:0>	D4:D2	<b>IC Operating Mode Select</b> 000 = Clockout (default) 001 = Standby 010 = Rx 011 = Tx 100 = Tx calibration 101 = RF loopback 11x = Baseband loopback
RFBW	D1	<b>RF Bandwidth</b> 0 = 20MHz 1 = 40MHz (default)
M/L_SEL	D0	<b>Main or Local Address Select</b> 0 = Main registers (default) 1 = Local registers

**Table 4. Main Address 1: (A4:A0 = 00001, Main Address 0 D0 = 0)**

BIT NAME	BIT LOCATION (D0 = LSB)	DESCRIPTION
RESERVED	D9:D8	Reserved bits; set to default
LNA_GAIN<2:0>	D7:D5	<b>LNA Gain Control</b> Active when Rx channel is selected by corresponding RX_PATH_UNMASK<5:1> bits in Main address 6 D9:D5. 000 = Maximum - 40dB 001 = Maximum - 32dB 100 = Maximum - 24dB 101 = Maximum - 16dB 110 = Maximum - 8dB 111 = Maximum gain (default)
VGA_GAIN<4:0>	D4:D0	<b>Rx VGA Gain Control</b> Active when Rx channel is selected by corresponding RX_PATH_UNMASK<5:1> bits in Main address 6 D9:D5. 00000 = Minimum gain 00001 = Minimum + 2dB ... 01110 = Minimum + 28dB 01111 = Minimum + 30dB ... 1xxxx = Minimum + 30dB (default)

**Table 5. Main Address 2: (A4:A0 = 00010, Main Address 0 D0 = 0)**

BIT NAME	BIT LOCATION (D0 = LSB)	DESCRIPTION
RESERVED	D9:D7	Reserved bits; set to default
LNA_BAND<1:0>	D6:D5	<b>LNA Frequency Band Switch</b> 00 = 4.9GHz~5.2GHz 01 = 5.2GHz~5.5GHz (default) 10 = 5.5GHz~5.8GHz 11 = 5.8GHz~5.9GHz
RESERVED	D4:D0	Reserved bits; set to default

**Table 6. Main Address 3: (A4:A0 = 00011, Main Address 0 D0 = 0)**

BIT NAME	BIT LOCATION (D0 = LSB)	DESCRIPTION
RESERVED	D9:D8	Reserved bits; set to default
TS_EN	D7	<b>Temperature Sensor Enable</b> 0 = Disable (default) 1 = Enable except shutdown or clockout mode
TS_TRIG	D6	<b>Temperature Sensor Reading Trigger</b> 0 = Not trigger (default) 1 = Trigger temperature reading
RESERVED	D5	Reserved bits; set to default
TS_READ<4:0>	D4:D0	SPI readback only. Temperature sensor reading.

**Table 7. Main Address 5: (A4:A0 = 00101, Main Address 0 D0 = 0)**

BIT NAME	BIT LOCATION (D0 = LSB)	DESCRIPTION
RESERVED	D9	Reserved bits; set to default
RSSI_MUX_SEL<2:0>	D8:D6	<b>RSSI Output Select</b> 000 = Baseband RSSI (default) 001 = Do not use 010 = Do not use 011 = Do not use 100 = Rx RF detector 101 = Do not use 110 = PA power-detector mux output 111 = Do not use
RESERVED	D5:D2	Reserved bits; set to default
RXHP	D1	<b>Rx VGA Highpass Corner Select after Rx Turn-On</b> RXHP starts at 1 during Rx gain adjustment, and set to 0 after gain is adjusted. 0 = 10kHz highpass corner after Rx gain is adjusted (default) 1 = 600kHz highpass corner during Rx gain adjustment
RESERVED	D0	Reserved bits; set to default

**Table 8. Main Address 9: (A4:A0 = 01001, Main Address 0 D0 = 0)**

BIT NAME	BIT LOCATION (D0 = LSB)	DESCRIPTION
TX_GAIN<5:0>	D9:D4	<b>Tx VGA Gain Control</b> Tx channel is selected by Main address 9 D3:D0. 000000 = Minimum gain (default) ... 111111 = Minimum gain + 31.5dB
TX_GAIN_PROG_SEL<4:1>	D3:D0	<b>Tx Channel Gain Programming Select</b> Gain is determined by Main address 9 D9:D4. 0 = Not selected 1 = Selected 1111 = Default

**Table 9. Main Address 11: (A4:A0 = 01011, Main Address 0 D0 = 0)**

BIT NAME	BIT LOCATION (D0 = LSB)	DESCRIPTION
RESERVED	D9:D4	Reserved bits; set to default
E_TX_AMD<1:0>	D3:D2	<b>Tx Calibration AM Detector Channel Select</b> Only active in Tx calibration mode. 00 = Select TX1 (default) 01 = Select TX2 10 = Select TX3 11 = Select TX4
PA_DET_SEL<1:0>	D1:D0	<b>PA Power-Detector Mux Output Select</b> 00 = Select PA_DET1 (default) 01 = Select PA_DET2 10 = Select PA_DET3 11 = Select PA_DET4

BIT NAME	BIT LOCATION (D0 = LSB)	DESCRIPTION
RESERVED	D9:D2	Reserved bits; set to default
DOUT_SEL	D1	<b>DOUT Pin Output Select</b> 0 = PLL lock detect (default) 1 = SPI readback
RESERVED	D0	Reserved bits; set to default

**Table 11. Main Address 15: (A4:A0 = 01111, Main Address 0 D0 = 0)**

BIT NAME	BIT LOCATION (D0 = LSB)	DESCRIPTION
VAS_TRIG_EN	D9	<b>Enable VCO Sub-Band Acquisition Triggered by SYN_CONFIG_F&lt;9:0&gt; (Main Address 17) Programming</b> 0 = Disable for small frequency adjustment (i.e., ~100kHz) 1 = Enable for channel switching (default)
RESERVED	D8:D7	Reserved bits; set to default
SYN_CONFIG_N<6:0>	D6:D0	<b>Integer Divide Ratio</b> 1000010 = Default

**Table 12. Main Address 16: (A4:A0 = 10000, Main Address 0 D0 = 0)**

BIT NAME	BIT LOCATION (D0 = LSB)	DESCRIPTION
SYN_CONFIG_F<19:10>	D9:D0	<b>Fractional Divide Ratio MSBs</b> 1110000000 = Default

**Table 13. Main Address 17: (A4:A0 = 10001, Main Address 0 D0 = 0)**

BIT NAME	BIT LOCATION (D0 = LSB)	DESCRIPTION
SYN_CONFIG_F<9:0>	D9:D0	<b>Fractional Divide Ratio LSBs</b> 0000000000 = Default

**Table 14. Main Address 18: (A4:A0 = 10010, Main Address 0 D0 = 0)**

BIT NAME	BIT LOCATION (D0 = LSB)	DESCRIPTION
RESERVED	D9:D8	Reserved bits; set to default
XTAL_TUNE<7:0>	D7:D0	<b>Crystal Oscillator Frequency Tuning</b> 00000000 = Minimum frequency 10000000 = Default 11111111 = Maximum frequency

**Table 15. Main Address 19: (A4:A0 = 10011, Main Address 0 D0 = 0)**

BIT NAME	BIT LOCATION (D0 = LSB)	DESCRIPTION
RESERVED	D9:D8	Reserved bits; set to default
VAS_RELOCK_SEL	D7	<b>VAS Relock Select</b> 0 = Start at sub-band selected by VAS_SPI<5:0> (Main address 19 D5:D0) (default) 1 = Start at current sub-band
VAS_MODE	D6	<b>VCO Subband Select</b> 0 = By VAS_SPI<5:0> (Main address 19 D5:D0) 1 = By on-chip VCO autoselect (VAS) (default)

**Table 15. Main Address 19: (A4:A0 = 10011, Main Address 0 D0 = 0) (continued)**

BIT NAME	BIT LOCATION (D0 = LSB)	DESCRIPTION
VAS_SPI<5:0>	D5:D0	<b>VCO Autoselect Sub-Band Input</b> Select VCO sub-band when VAS_MODE (Main address 19 D6) = 0. Select initial VCO sub-band for autoacquisition when VAS_MODE = 1. 000000 = Minimum frequency sub-band ... 011111 = Default ... 111111 = Maximum frequency sub-band
VAS_ADC<2:0> (Readback Only)	D8:D6	<b>Read VCO Autoselect Tune Voltage ADC Output</b> Active when VCO_VAS_RB (Main address 27 D5) = 1. 000 = Lower than lock range and at risk of unlock 001 = Lower than acquisition range and maintain lock 010 or 101 = Within acquisition range and maintain lock 110 = Higher than acquisition range and maintain lock 111 = Higher than lock range and at risk of unlock
VCO_BAND<5:0> (Readback Only)	D5:D0	<b>Read the Current Acquired VCO Sub-Band by VCO Autoselect</b> Active when VCO_VAS_RB (Main address 27 D5) = 1.

**Table 16. Main Address 21: (A4:A0 = 10101, Main Address 0 D0 = 0)**

BIT NAME	BIT LOCATION (D0 = LSB)	DESCRIPTION
RESERVED	D9:D0	Reserved bits; set to default
DIE_ID<2:0> (Readback Only)	D7:D5	<b>Read Revision ID at Main Address 21 D7:D5</b> Active when DIE_ID_READ (Main address 27 D9) = 1. 000 = Pass1 001 = Pass2 ...

**Table 17. Main Address 27: (A4:A0 = 11011, Main Address 0 D0 = 0)**

BIT NAME	BIT LOCATION (D0 = LSB)	DESCRIPTION
DIE_ID_READ	D9	<b>Die ID Readback Select</b> 0 = Main address 21 D9:D0 reads its own values (default) 1 = Main address 21 D7:D5 reads revision ID
RESERVED	D8:D6	Reserved bits, set to default
VAS_VCO_READ	D5	<b>VAS ADC and VCO Sub-Band Readback Select</b> 0 = Main address 19 D9:D0 reads its own values (default). 1 = Main address 19 D8:D6 reads VAS_ADC<2:0>; Main address 19 D5:D0 reads VCO_BAND<5:0>.
RESERVED	D4:D0	Reserved bits; set to default

**Table 18. Main Address 28: (A4:A0 = 11100, Main Address 0 D0 = 0)**

BIT NAME	BIT LOCATION (D0 = LSB)	DESCRIPTION
RESERVED	D9:D4	Reserved bits; set to default
PA_BIAS_DLY<3:0>	D3:D0	<b>PA_BIAS Turn-On Delay</b> 0000 = 0 $\mu$ s 0001 = 0 $\mu$ s 0010 = 0.5 $\mu$ s 0011 = 1.0 $\mu$ s (default) ... 1111 = 7.0 $\mu$ s

**Table 19. Local Address 27: (A4:A0 = 11011, Main Address 0 D0 = 1)**

BIT NAME	BIT LOCATION (D0 = LSB)	DESCRIPTION
RESERVED	D9:D3	Reserved bits, set to default
TX_AMD_BB_GAIN	D2	<b>Tx Calibration AM Detector Baseband Gain</b> 0 = Minimum gain (default) 1 = Minimum gain + 5dB
TX_AMD_RF_GAIN	D1:D0	<b>Tx Calibration AM Detector RF Gain</b> 00 = Minimum gain (default) 01 = Minimum gain + 14dB rise at output 1x = Minimum gain + 28dB rise at output

Typical Operating Circuit

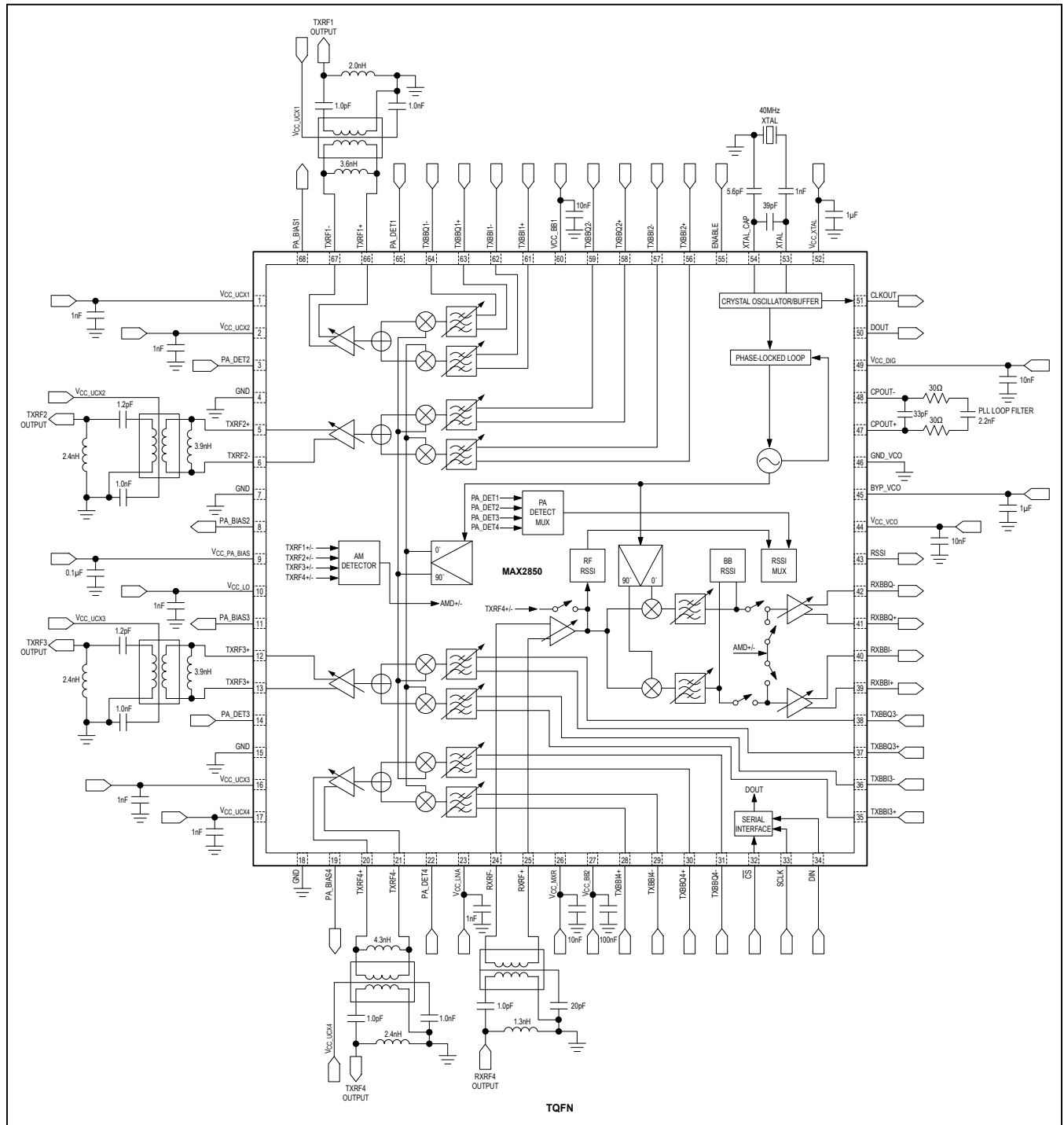

## Chip Information

PROCESS: BICMOS

## Package Information

For the latest package outline information and land patterns (footprints), go to [www.maximintegrated.com/packages](http://www.maximintegrated.com/packages). Note that a "+", "#", or "-" in the package code indicates RoHS status only. Package drawings may show a different suffix character, but the drawing pertains to the package regardless of RoHS status.

PACKAGE TYPE	PACKAGE CODE	DOCUMENT NO.
68 TQFN-EP	T6800+2	21-0142



## Revision History

REVISION NUMBER	REVISION DATE	DESCRIPTION	PAGES CHANGED
0	10/09	Initial release	—
1	3/10	Modified EC table to support single-pass room test flow	2, 3, 5, 6, 8
2	1/19	Updated <i>Absolute Maximum Ratings</i>	2

For pricing, delivery, and ordering information, please visit Maxim Integrated's online storefront at <https://www.maximintegrated.com/en/storefront/storefront.html>.

*Maxim Integrated cannot assume responsibility for use of any circuitry other than circuitry entirely embodied in a Maxim Integrated product. No circuit patent licenses are implied. Maxim Integrated reserves the right to change the circuitry and specifications without notice at any time. The parametric values (min and max limits) shown in the Electrical Characteristics table are guaranteed. Other parametric values quoted in this data sheet are provided for guidance.*