

Description

Electronic circuit protector type ESX10-TC is designed to ensure **selective** disconnection of DC 12 V load systems.

DC 12 V power supplies, which are widely used in industry today, will shut down the output in the event of an overload with the result that one faulty load in the system can lead to complete disconnection of all loads. As well as an unidentified failure this also means stoppage of the whole system.

Through **selective** disconnection the ESX10-TC responds much faster to overload or short circuit conditions than the switch-mode power supply. This is achieved by active current limitation. The ESX10-T limits the highest possible current to 1.3 to 1.8 times the selected rated current of the circuit protector. Thus it is possible to switch on **capacitive loads of up to 75,000 µF**, but they are disconnected only in the event of an overload or short circuit.

For optimal alignment with the characteristics of the application the current rating of the ESX10-TC can be selected in fixed values from 1 A...10 A. Failure and status indication are provided by a multicolour LED and an integral short-circuit-proof status output. Remote operation is possible by means of a remote reset signal or a remote ON/OFF control signal. The manual ON/OFF button allows separate actuation of individual load circuits.

The ESX10-TC, with a width of only 12.5 mm, can be snapped onto symmetrical rails ensuring ease of installation and saving space in control cabinets.

Upon detection of overload or short circuit in the load circuit, the MOSFET of the load output will be blocked to interrupt the current flow. The load circuit can be re-activated via the remote electronic reset input, control input or manually by means of the ON/OFF button.

US patent number: US 6,490,141 B2
US patent number: US 8,237,311 B2

Features

- Selective load protection, electronic trip characteristics.
- Active current limitation for safe connection of capacitive loads up to 75,000 µF and on overload/short circuit.
- Current ratings 1 A...10 A at DC 12 V.
- Reliable overload disconnection with $1.1 \times I_N$ plus, even with long load lines or small cable cross sections.
- Manual ON/OFF button (S1).
- Control input IN+ for remote ON/OFF signal (option).
- Electronic reset input RE (option).
- Clear status and failure indication through LED, status output SF.
- Integral fail-safe element adjusted to current rating.
- Width per unit only 12.5 mm.
- Rail mounting
- Ease of wiring through busbar LINE+ and 0 V.
- Additional versions with ATEX approval available.

Marking: © II 3G Ex nA IIB T4 Gc X

ESX10-TC...-E

Please observe separate operating instructions:



ESX10-TC

Technical data (T_{ambient} = 25 °C, operating voltage U_S = DC 12 V)

Operating data

Operating voltage U _S	DC 12 V (9...18 V)
Current rating I _N	fixed current ratings: 1 A, 2 A, 3 A, 4 A, 6 A, 10 A
Closed current I ₀	ON condition: typically 15...20 mA
Status indication by means of	<ul style="list-style-type: none"> • multicolour LED: Green: unit is ON, power-MOSFET is switched on - status output SF ON, supplies +DC 12 V Orange: in the event of overload or short circuit until electronic disconnection Red: - unit electronically disconnected - load circuit/Power-MOSFET OFF - low voltage (< 3.25 V) - after switch-on until end of switch-on delay OFF: - manually switched off (S1 = OFF) or device is dead - undervoltage • status output SF (option) • ON/OFF condition of switch S1

Load circuit

Load output	Power-MOSFET switching output (high side switch)
Overload disconnection	typically $1.1 \times I_N$ (1.05...1.35 $\times I_N$)
Short-circuit current I _k	active current limitation (see table 1)
Trip time for electronic disconnection	see time/current characteristics typically 3 s at I _{Load} > 1.1 $\times I_N$ typically 50 ms...3 s at I _{Load} > 1.8 $\times I_N$ (or 1.5 $\times I_N$)
Temperature disconnection	internal temperature monitoring with electronic disconnection
Low voltage monitoring load output	with hysteresis at voltage dips < 500 ms, no reset required: load "OFF" at U _B < 3.2 V
Starting delay t _{start}	typically 10 ms
Disconnection of load circuit	electronic disconnection
Free-wheeling circuit	external free-wheeling diode recommended with inductive load

Several load outputs must not be connected in parallel

Technical data (T_{ambient} = 25 °C, operating voltage U_S = DC 12 V)

Status output SF	ESX10-TC-114/-124
Electrical data	plus-switching signal output, connects U _S to terminal 12 of module 17plus nominal data: DC 12 V/max. 0.2 A (short circuit proof) status output is internally connected to GND with a 10 kΩ resistor
Status OUT	ESX10-TC-114/-124 (signal status OUT), +12 V = S1 is ON, load output connected through 0V = S1 is ON, load output blocked and/or switch S1 is OFF red LED lighted
OFF condition	0 V level at status output when: <ul style="list-style-type: none"> switch S1 is in ON position, but device is still in switch-on delay switch S1 is OFF, or control signal OFF, device is switched off no operating voltage U_S
Reset input RE	ESX10-TC-124
Electrical data	voltage: max. +DC 32 V high > DC 4.5 V ≤ DC 18 V low ≤ DC 2.5 V > 0 V power consumption typically 1.4 mA (+DC 12 V) min. pulse duration typically 10 ms
Reset signal RE (terminal 22)	The electronically blocked ESX10-TC-124 may remotely be reset via an external momentary switch due to the falling edge of a + DC 12 V pulse. A common reset signal can be applied to several devices simultaneously. Switched on devices remain unaffected.
Control input IN+	ESX10-TC-114
Electrical data	see reset input RE
Control signal IN+	+ 12 V level (HIGH): device will be switched (terminal 21) on by a remote ON/OFF signal 0 V level (LOW): device will be switched off by a remote ON/OFF signal
Switch S1 ON/OFF	unit can only be switched on with S1 if a HIGH level is applied to IN+
General data	
Fail-safe element:	backup fuse for ESX10-T <u>not required</u> because of the integral redundant fail-safe element
Terminals	
LINE+ / LOAD+ / 0V	
screw terminals	M4
max. cable cross section	
flexible with wire end ferrule w/wo plastic sleeve	0.5 – 10 mm ²
multi-lead connection (2 identical cables)	
rigid/flexible	0.5 – 4 mm ²
flexible with wire end ferrule without plastic sleeve	0.5 – 2.5 mm ²
flexible with TWIN wire end ferrule with plastic sleeve	0.5 – 6 mm ²
wire stripping length	10 mm
tightening torque (EN 60934)	1.5 – 1.8 Nm
Terminals	
aux. contacts	
screw terminals	M3
max. cable cross section	
flexible with wire end ferrule w/wo plastic sleeve	0.25 – 2.5 mm ²
wire stripping length	8 mm
tightening torque (EN 60934)	0.5 – 0.6 Nm
Housing material	moulded
Mounting	symmetrical rail to EN 50022-35x7.5
Ambient temperature	-25...+60 °C ¹⁾ (without condensation, see EN 60204-1) with condensation upon request ¹⁾ Ambient temperature range can differ depending on approvals

Technical data (T_{ambient} = 25 °C, operating voltage U_S = DC 12 V)

Storage temperature	-40...+70 °C
Humidity	96 hrs/95 % RH/40 °C to IEC 60068-2-78, test Cab. climate class 3K3 to EN 60721
Vibration	3 g, test to IEC 60068-2-6 test Fc
Degree of protection	housing: IP20 DIN 40050 terminals: IP20 DIN 40050
EMC (EMC directive, CE logo)	emission: EN 61000-6-3 susceptibility: EN 61000-6-2
Insulation co-ordination (IEC 60934)	0.5 kV/2 pollution degree 2 re-inforced insulation in operating area
Dielectric strength	max. DC 18 V (load circuit)
Insulation resistance (OFF condition)	n/a, only electronic disconnection
Approvals	CE-logo UL 2367, File # E306740, Solid State Overcurrent Protectors UL 508, File # E322549
Dimensions (W x H x D)	12.5 x 80 x 83 mm
Mass	approx. 65 g

Table 1: voltage drop, current limitation, max. load current

current rating I _N	typically voltage drop U _{ON} at I _N	active current limitation I _{Limit} (typically)	max. load current at 100% ON duty	
			T _a = 40 °C	T _a = 60 °C
1 A	80 mV	1.8 x I _N	1 A	1 A
2 A	130 mV	1.8 x I _N	2 A	2 A
3 A	80 mV	1.8 x I _N	3 A	3 A
4 A	100 mV	1.8 x I _N	4 A	4 A
6 A	130 mV	1.8 x I _N	6 A	6 A
10 A	150 mV	1.5 x I _N	10 A	9 A

Attention: when mounted side-by-side without convection the ESX10-T should not carry more than 80 % of its rated load with 100 % ON duty due to thermal effects.

Attention

Please note:

- The user should ensure that the cable cross sections of the relevant load circuit are suitable for the current rating of the ESX10-T used.
- Automatic start-up of machinery after shut down must be prevented (Machinery Directive 98/37/EG and EN 60204-1). In the event of a short circuit or overload the load circuit will be disconnected electronically by the ESX10-T.

Ordering configuration for ATEX versions: ...-E

Type No.	
ESX10	Electronic Circuit Protector, with current limitation
Mounting and design	
TC	rail mounting, with signal contact and slot for busbars and jumpers
Version	
1	standard, without physical isolation
Signal input	
1	with control input IN+
2	with reset input RE
Signal output	
4	status output SF
Operating voltage	
DC 12 V	rated voltage DC 12 V
Current rating	
1...10 A	
Approvals	
E	ATEX
ESX10 - TC	1 2 4 - DC 12 V - 10 A - E ordering example

Ordering information

Type No.	
ESX10	Electronic Circuit Protector, with current limitation
Mounting and design	
TC	rail mounting, with signal contact and slot for busbars and jumpers
Version	
1	standard, without physical isolation in the event of a failure
Signal input	
1	with control input IN+, only ESX10-T-114
2	with reset input RE, only ESX10-T-124
Signal output	
4	status output SF (only ESX10-T-114, ESX10-T-124)
Operating voltage	
DC 12 V	rated voltage DC 12 V
Current rating	
1 A	
2 A	
3 A	
4 A	
6 A	
10 A	
ESX10 - TC	1 2 4 - DC 12 V - 10 A ordering example

Description of ESX10-T signal inputs and outputs (wiring diagrams) see next page.

Approvals

ESX10-TC			
Authority	Standard	Voltage ratings	Current ratings
UL	UL 2367	DC 12 V	1 A...12 A
UL	UL 1604	DC 12 V	1 A...10 A
UL	UL 508 C22.2 No 14	DC 12 V	1 A...10 A
TÜV	ATEX 94/9/EC Annex VIII EN 60079-0 EN 60079-11 EN 60079-15	DC 12 V	
GL	Rules VI, part 7, GL 2012, cate- gory C, EMC1	DC 12 V	1 A...10 A

Information on UL approvals

 **ESX10-TC**
UL1604
UL File # E320024

Operating Temperature Code T5

- This equipment is suitable for use in Class I, Division 2, Groups A, B, C and D or non-hazardous locations only

WARNING:

- Exposure to some chemicals may degrade the sealing properties of materials used in the following device: relay

Sealant Material:

Generic Name: Modified diglycidyl ether of bisphenol A
Supplier: Fine Polymers Corporation
Type: Epi Fine 4616L-160PK

Casing Material:

Generic Name: Liquid Crystal Polymer
Supplier: Sumitomo Chemical
Type: E4008, E4009, or E6008

RECOMMENDATION:

- Periodically inspect the device named above for any degradation of properties and replace if degradation is found

WARNING – EXPLOSION HAZARD:

- Do not disconnect equipment unless power has been removed or the area is known to be non-hazardous
- Substitution of any components may impair suitability for Class I, Division 2

 **ESX10-TC**
UL2367
Non-hazardous use - UL File # E306740

 **ESX10-TC**
UL 508
Non-hazardous use - UL File # E322549

Class 2

Meets requirement for Class 2 current limitation (ESX10-TC...-1 A/2 A/3 A/4 A/6 A)



Instruction leaflet



Electronic Circuit Protector
ESX10-TC-DC 12 V

 **UL1604**
UL File # E320024
This device is suitable for use in Class I, Div 2, Groups A, B, C, D; TC T5; Hazardous locations or nonhazardous locations only

Warnings:
1. Remove power before disconnecting device or the area is known to be non-hazardous.
2. Components substitutions may impair suitability of Class I, Div 2.
3. Chemical exposure may degrade internal relay's sealing property.

 **UL2367**  **UL508**  **UL508**
Non-hazardous use Non-hazardous use Non-hazardous use
UL File # E306740 UL File # E322549

Refer to data sheet / installation guidelines for installation and safety instructions.

E-T-A Elektrotechnische Apparate GmbH
Industriestraße 2-8 · D-90518 ALTENDORF
GERMANY
Phone: +49 9187 10-0 · Fax: +49 9187 10-397
E-Mail: info@e-t-a.de · www.e-t-a.de

EG-declaration of Conformity for ATEX-version ESX10-TC-...-E



E-T-A Elektrotechnische Apparate GmbH

Diese Konformitätserklärung folgt den grundlegenden Anforderungen der Norm EN ISO/IEC 17050-1:2010
Konformitätsbewertung - Konformitätserklärung von Anbietern - Teil 1: Allgemeine Anforderungen.

This Declaration of Conformity is following the basic requirements of the standard EN ISO/IEC 17050-1:2010
Conformity assessment - Supplier's declaration of conformity - Part 1: General requirements.

EU-Konformitätserklärung Nr. 100.218.1018-03
Declaration of Conformity

Wir **E-T-A Elektrotechnische Apparate GmbH**
We Industriestraße 2-8, D-90518 Altdorf, Germany
(Name und Anschrift des Anbieters / supplier's name and address)

erklären in alleiniger Verantwortung, dass das Produkt
declare under our sole responsibility that the product

Elektronischer Sicherungsautomat
Solid state overcurrent protector

ESX10-TA (Hutschienenmontage 24Vdc / rail mounting 24Vdc)
ESX10-TB (Hutschienenmontage 24Vdc / rail mounting 24Vdc)
ESX10-... (Steckmontage, mit Modul 17PLUS, 24Vdc / plug-in mounting with module 17PLUS, 24Vdc)
ESX10-TC (Hutschienenmontage 12Vdc / rail mounting 12Vdc)
(Bezeichnung, Typ/Modell, evtl. Spezifikation/ name, type/model, optionally specification)

auf das sich diese Erklärung bezieht, mit den wesentlichen
Anforderungen folgender Richtlinie(n) übereinstimmt:
to which this declaration relates, is in conformity with the essential requirements of following Directive(s)

2014/34/EU ATEX-Richtlinie / ATEX Directive

Zur Beurteilung der Übereinstimmung wurde(n) folgende Norm(en)
oder normative Dokumente herangezogen:
For evaluation of the conformity following standard(s) or normative document(s) were consulted:

DIN EN 60079-0:2014-06
Explosionsgefährdete Bereiche - Teil 0: Betriebsmittel - Allgemeine
Anforderungen
Explosive atmospheres - Part 0: Equipment - General requirements
EN 60079-15: 2010 - Explosive Atmosphäre - Geräteschutz durch
Zündschutzart „n“
Explosive atmospheres - Equipment protection by type of protection „n“

(Titel und/oder Nr. sowie Ausgabedatum der Norm(en) oder der anderen normati- ven
Dokumente / Title and /or number and date of issue of the standard(s) or other _ normative
document(s))

D-90518 Altdorf/bel Nürnberg • Germany • Telephone +49 9187 / 10-0 • Facsimile +49 9187 / 10-398
1/2



E-T-A Elektrotechnische Apparate GmbH

EU-Konformitätserklärung Nr. 100.218.1018-03
Declaration of Conformity

Zusätzliche Angaben: Additional information:

II 3G Ex nA IIB T4 Gc X
-20°C≤Tas≤+60°C (für / for ESX10-TC)
0°C≤Tas≤+50°C (für / for ESX10, ESX10-TA, ESX10-TB)

Besondere Bedingungen: Special conditions:

Die zugehörige Betriebsanleitung enthält wichtige sicherheitstechnische Hinweise und Vorschriften für die Inbetriebnahme der genannten Geräte gemäß der Richtlinie 2014/34/EU (ATEX)
The pertinent user manual is including important safety-related information and regulations for placing into operation of the described devices in accordance with Directive 2014/34/EU (ATEX).

Werden die Produkte in eine übergeordnete Maschine/Anlage eingebaut, so müssen die durch den Einbau entstehenden neuen Risiken durch den Hersteller der neuen Maschine/Anlage beurteilt werden.
In case the products will be fitted into a higher-level machine or system, the manufacturer of the new machine or system needs to assess possible new risks resulting from this action.

Altdorf, 28. Jun 2016

Dr. Clifford Sell

Dr. Clifford Sell
Geschäftsführer

Ralf Dietrich

Ralf Dietrich
Ltg. Produkt-, Marktentwicklung

(Ort und Datum der Ausstellung / Place and date of issue) (Name, Funktion, Unterschrift des/der Befugten / name, function, signature of authorized person(s))

D-90518 Altdorf/bel Nürnberg • Germany • Telephone +49 9187 / 10-0 • Facsimile +49 9187 / 10-398
2/2

Dimensions

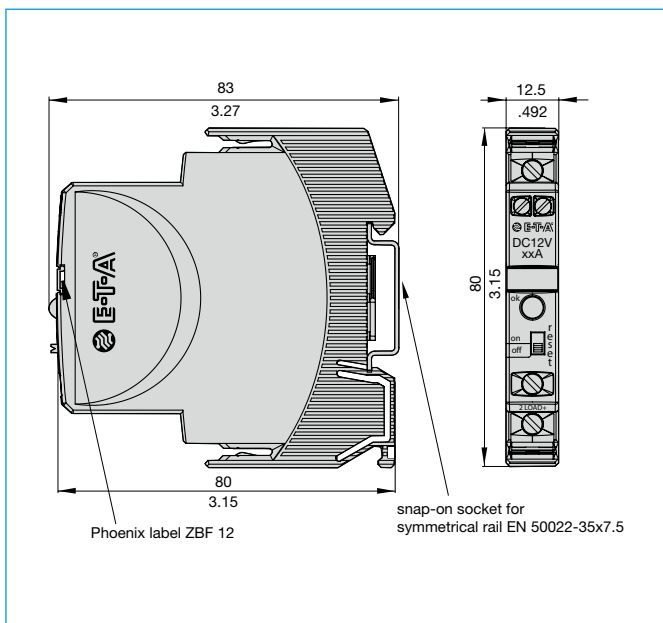

Schematic diagram ESX10-TC-124-DC 12 V (Example)

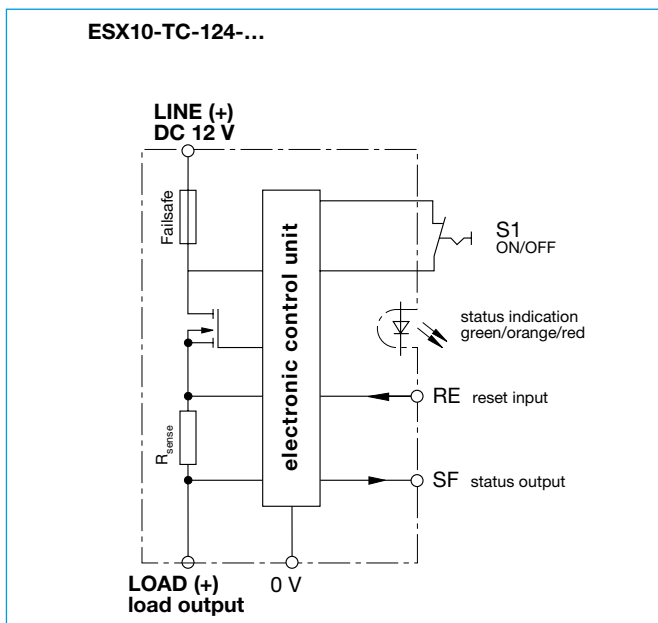

Terminal wiring diagram ESX10-TC-124-DC 12 V (Example)

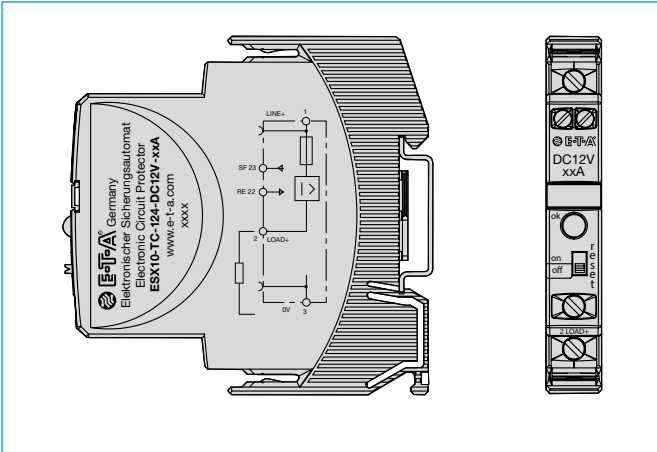
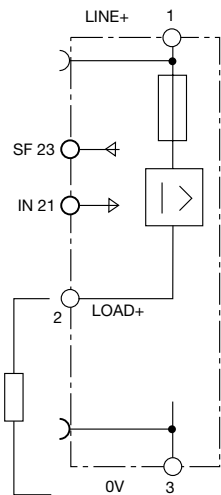

Table 2 : ESX10-T - product version

Version	Signal input	Signal output
ESX10-.. DC 12 V	Control input ON/OFF + 12 V Control IN+	Status output SGF OUT + 12 V = OK
-TC -114	x	x
-TC -124		x

ESX10-T Signal inputs / outputs (wiring diagram)

ESX10-TC-114-DC12V
with control input IN+
(+DC 12 V)
with status output SF
(+12 V = load output ON)



operating condition:
SF +12 V = OK

fault condition:
SF 0 V

ESX10-TC-124-DC12V
with reset input RE
(+DC 12 V ↓)
with status output SF
(+12 V = load output ON)

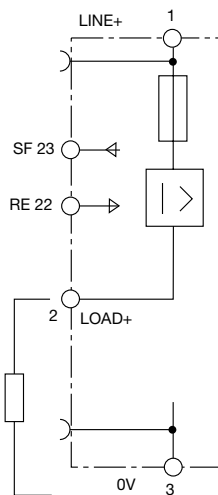

operating condition:
SF +12 V = OK

fault condition:
SF 0 V

Time/Current characteristic curve ($T_A = 25^\circ\text{C}$)

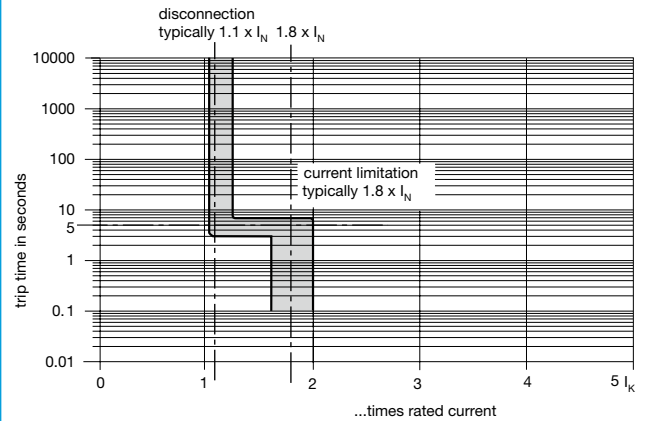

*1) current limitation typically $1.8 \times I_N$
times rated current at $I_N = 0.5 \text{ A} \dots 6 \text{ A}$

current limitation typically $1.5 \times I_N$
times rated current at $I_N = 8 \text{ A}$ or 10 A

- The trip time is typically 3 s in the range between 1.1 and $1.8 \times I_N^{*1}$.
- Electronic current limitation occurs at typically $1.8 \times I_N^{*1}$ which means that under all overload conditions (independent of the power supply and the resistance of the load circuit) the max. overload before disconnection will not exceed $1.8 \times I_N^{*1}$ times the current rating. Trip time is between 100 ms and 3 sec (depending on overload or at short circuit).
- Without this current limitation a considerably higher overload current would flow in the event of an overload or short circuit.

Mounting examples for ESX10-TC

The ESX10-TC-DC 12 V features an integral power distribution system.

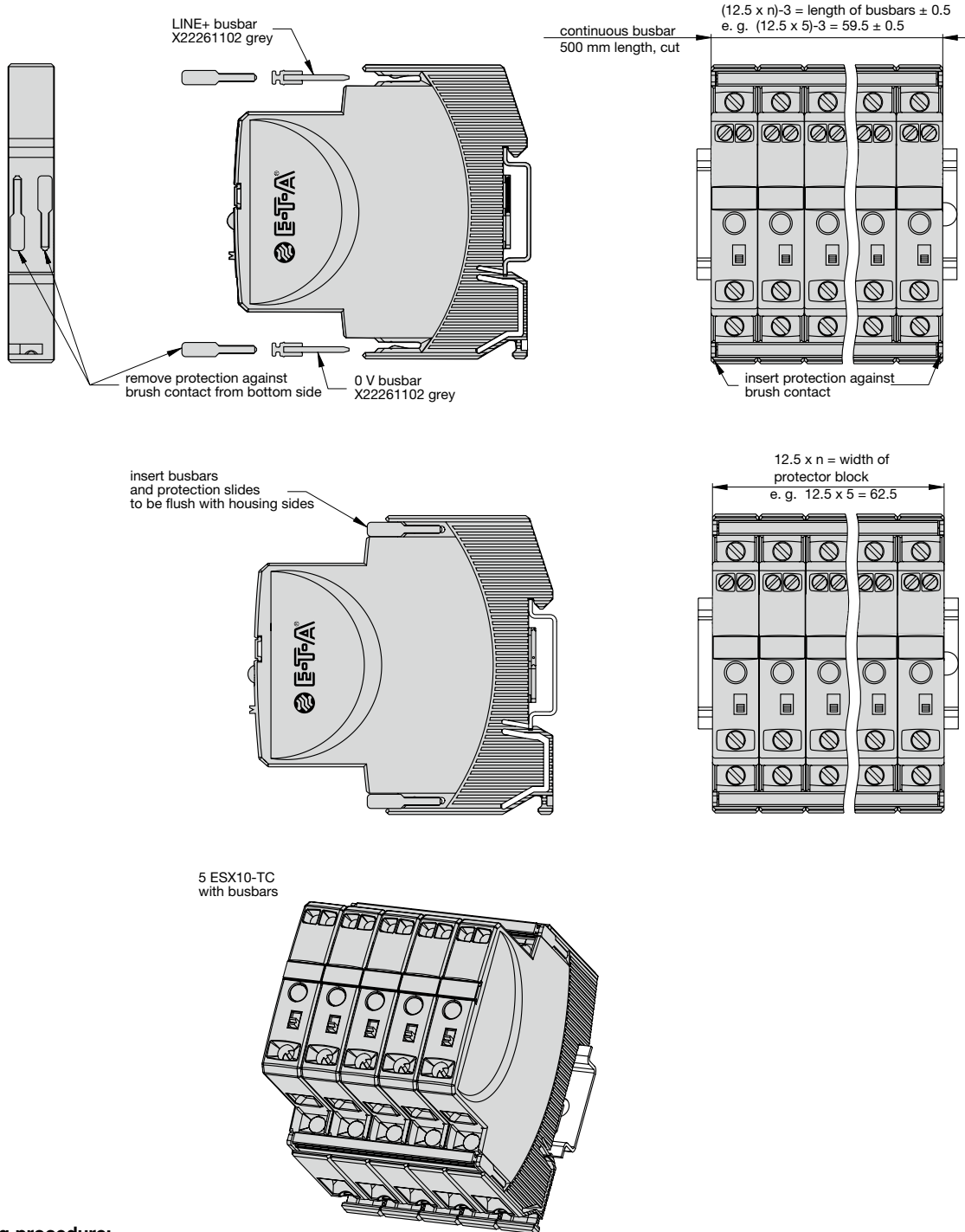

Mounting procedure:

Before wiring insert busbars into protector block.
Max. 10 insertion/removal cycles for busbars.

Recommendation:

Every 10 units busbars should be interrupted and fed in anew.

Table of lengths for busbars

(X 222 611 02 see accessories)

no. of units	2	3	4	5	6	7	8	9	10
Length of busbar [mm] ± 0.5 mm	22	34.5	47	59.5	72	84.5	97	109.5	122

Description

The ESX10-T features an integral power distribution system. The following wiring modes are possible with various pluggable current busbars:

- LINE +DC 12 V
- 0 V

Caution: The electronic devices ESX10-T require a 0 V connection

Accessories

Busbars for LINE+ and 0 V

max. load with one line entry I_{max} 50 A
 (recommended: centre line entry)
 max. load with two line entries I_{max} 63 A
 grey insulation, length: 500 mm
X 222 611 02

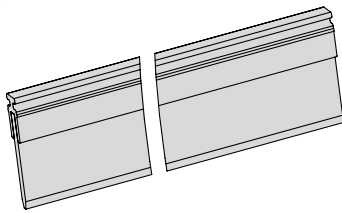

Busbars for LINE+ and 0 V

grey insulation
 max. number of plug-on operations 10:

X 222 611 34, (3-unit-block ESX10-T), length: 34.5 mm
X 222 611 47, (4-unit-block ESX10-T), length: 47 mm
X 222 611 59, (5-unit-block ESX10-T), length: 59.5 mm
 packing unit: 10 pcs

X 222 611 97, (8-unit-block ESX10-T), length: 97 mm
X 222 611 12, (10-unit-block ESX10-T), length: 122 mm
 packing unit: 4 pcs

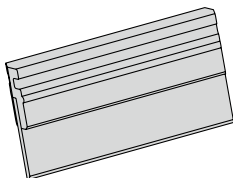

Supply module for LINE+ and 0 V

suitable for ESX10-T... versions
 ampacity I_{max} 50 A
AD-TX-EM01

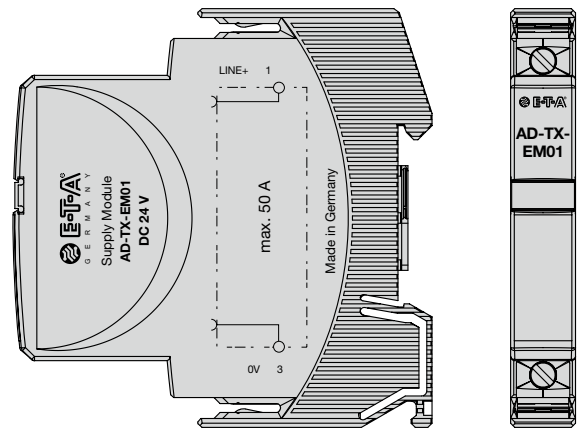

Connector bus link -K10

suitable for auxiliary contacts (series connection)
X 210 589 02 (1.5 mm², brown),

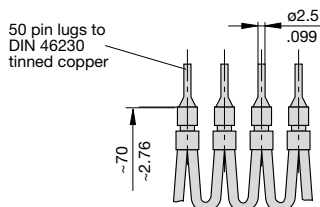

All dimensions without tolerances are for reference only. In the interest of improved design, performance and cost effectiveness the right to make changes in these specifications without notice is reserved. Product markings may not be exactly as the ordering codes. Errors and omissions excepted.

