

DETAILS

Product Number	CS14891_HB-IP-2X6-M
Family	HB
Type	Assembly
Color	clear
Diameter	173 + 71,4 mm
Height	11,39 mm
Style	rectang
Optic Material	PMMA
Holder Material	
Fastening	screw, pin
Status	production ready
ROHS Compliant	Yes
Date Updated	8/09/2016



OPTICAL PROPERTIES

LED	Viewing	Light	Effi-		Connector
	Angle	Beam	ciency	cd/lm	
XM-L	27 deg	Medium	94 %	3.100	-
XP-G3	32 deg	Medium	94 %	2.400	-
XP-L	39 deg	Medium	94 %	1.700	-
XP-L2	39 deg	Medium	94 %	1.700	-
XT-E	25 deg	Medium	92 %	3.100	-
H35C1 (LEMWA33)	sim: 35	Medium	sim: 94 %	sim: 2.100	-
LUXEON XR-TX (L2T0-xyy012M)	28 deg	Medium	94 %	2.950	-
LUXEON T	29 deg	Medium	94 %	2.700	-
NVSxE21A	24 deg	Medium	92 %	4.100	-
Oslon Square PC	29 deg	Medium	93 %	2.690	-
Z5M1/Z5M2	30 deg	Medium	93 %	2.630	-
Z8Y22P	30 deg	Medium	93 %	2.500	-

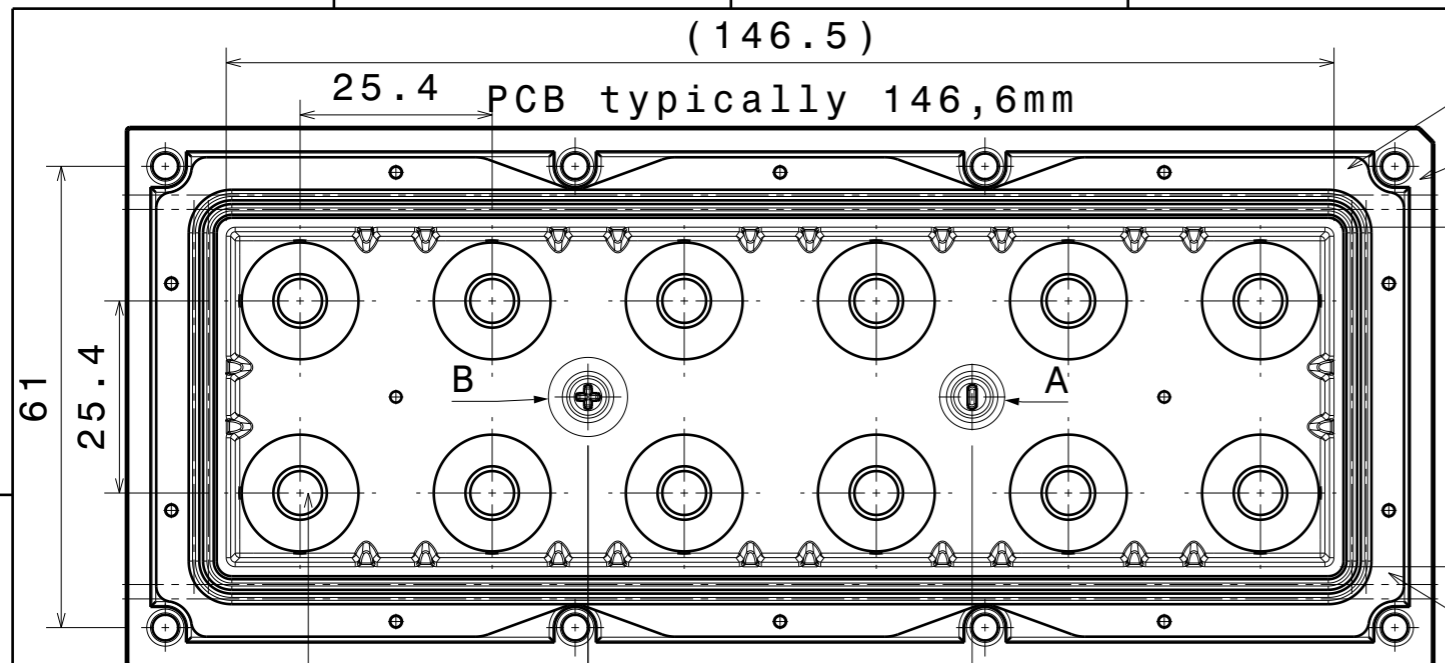

1
2
PCB typically 45mm
(44.9)
PCB typically 146,6mm

Wiring:
PCB is fully sealed between the lens with silicone seal and the heatsink. Wiring needs to be done through the PCB and heatsink to maintain high IP rating.

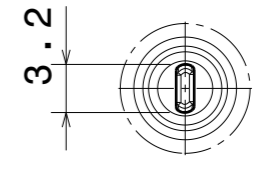

Detail A
Scale 2:1

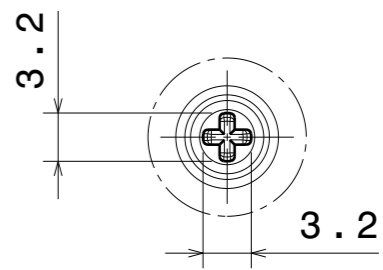

Detail B
Scale 2:1

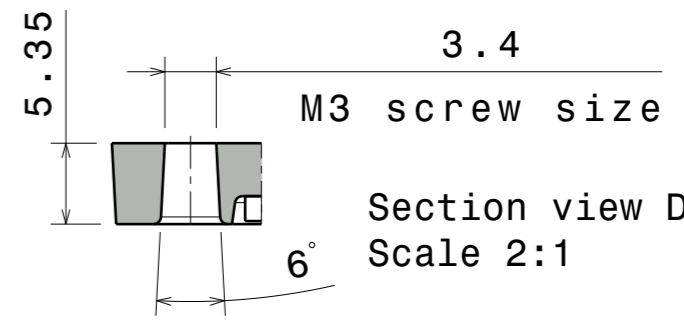

Section view D-D
Scale 2:1

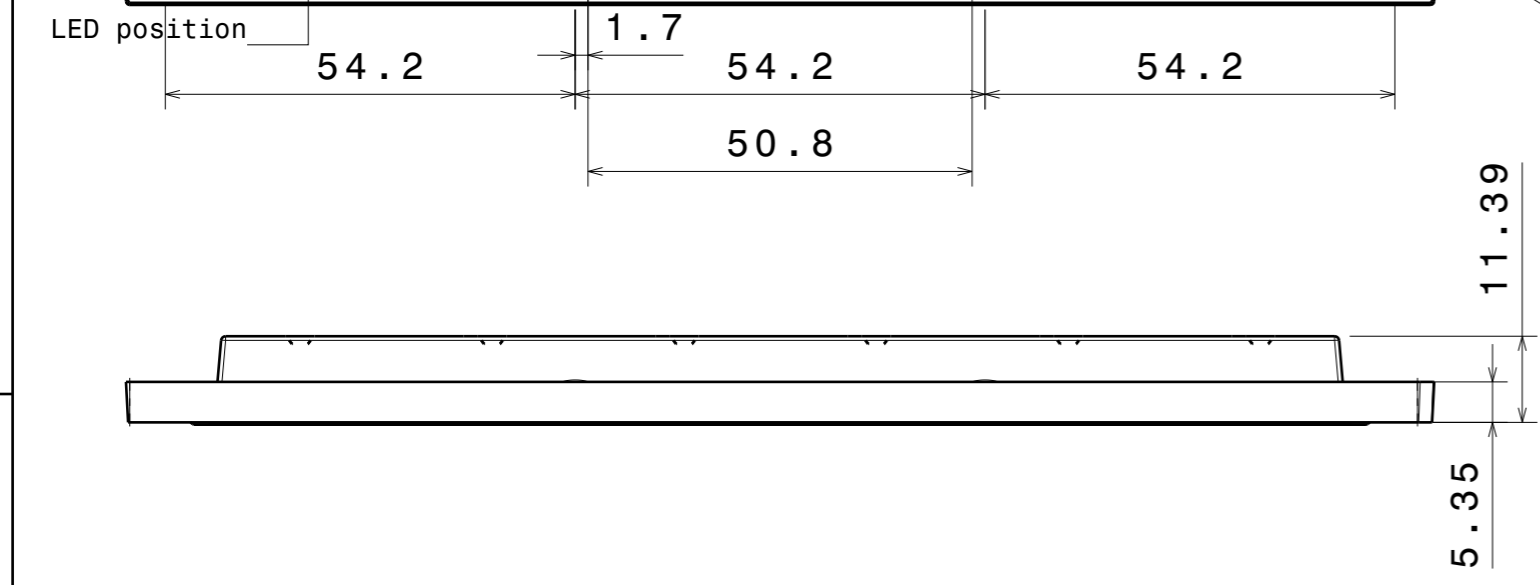

Silicone seal is tested to work in LEDiL test assemblies. Customer is recommended to test the sealing in the end product due many variables, such as heat sink surface and possible chemical traces

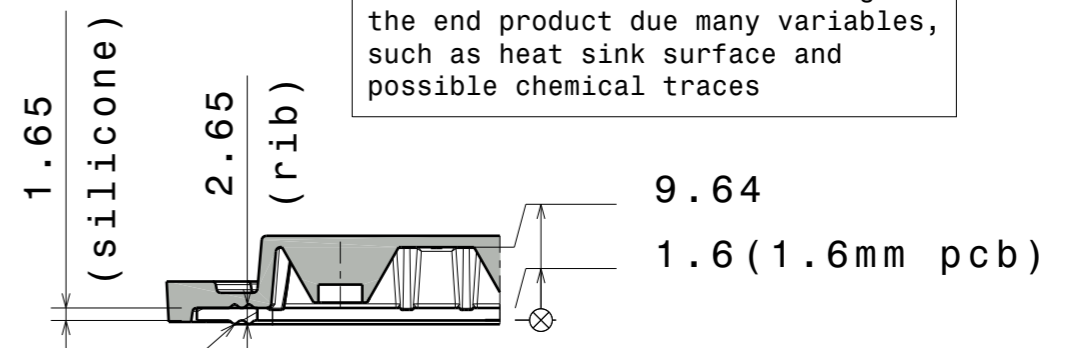

Section view C-C
Scale 1:1

Fasten middle screws first. Recommended torque with pan head screw: 0.57Nm (for 1.6mm thick PCB, no thermal pad)

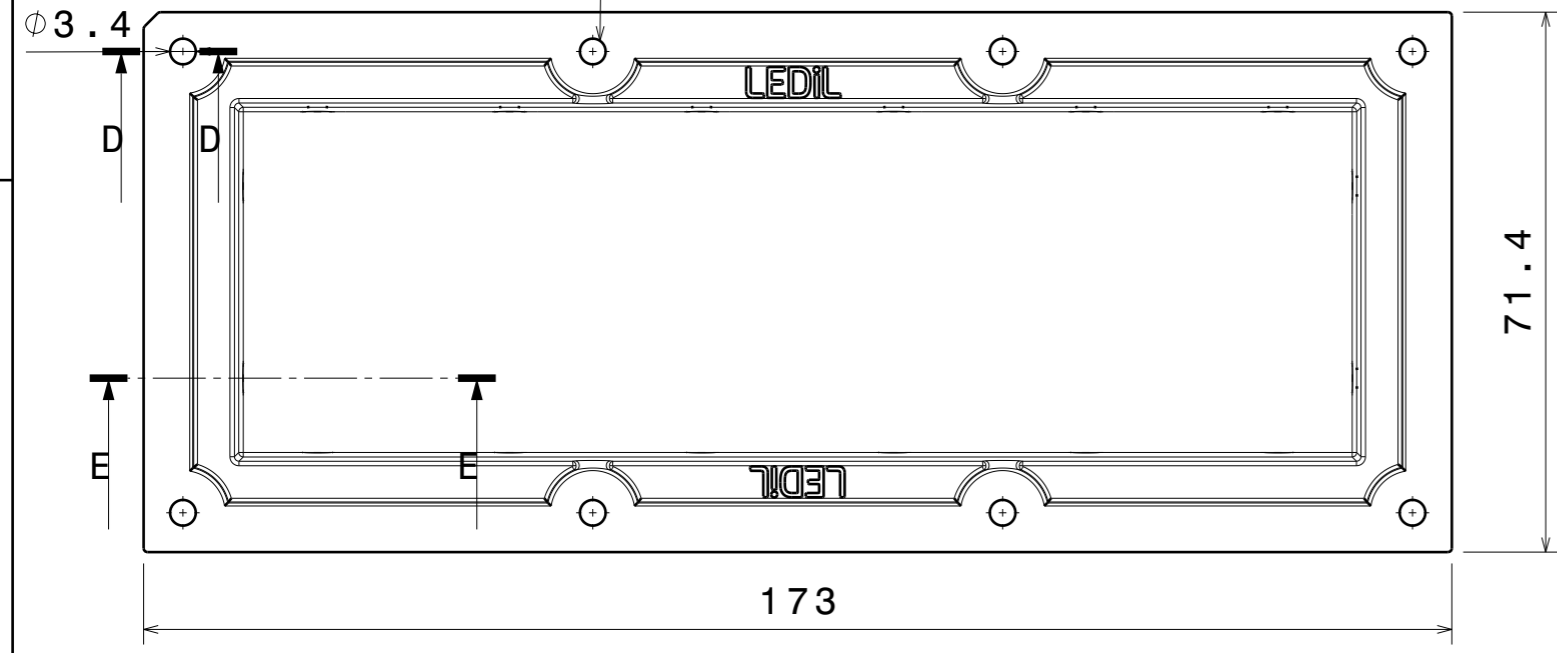

INDEX	PART NO	DESCRIPTION	MATERIAL	COLOUR
1	C14018	2X6-SEAL25	Silicone	
2	-	HB-IP-2X6	PMMA	

Tolerances if not otherwise shown
According to DIN ISO 2768-1
Linear measures:
up to 30mm class M, otherwise class C
According to DIN ISO 2768-2
Form and position: class L

LEDiL Ledil Oy
Salorankatu 10
FIN 24240 SALO
Finland

THIRD ANGLE PROJECTION:

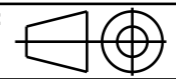

DRAWING TITLE
MechDrawing_HB-IP-2X6

This drawing is the property of LEDiL Oy. It may not be reproduced, copied or communicated without a written agreement with LEDiL Oy.

SIZE	PART NUMBER
A3	-

SCALE	1:1	WEIGHT	-	SHEET	1/1
-------	-----	--------	---	-------	-----

Luminaire: LEDiL Oy CS14891_HB-IP-2X6-M_(XM-L)_Cav1

Lamps: 1 x Cree_XM-L_(XMLAWT-00-0000-000LT2OE7)_985.421lm@250mA_P=8.11375W_I=0.2499A

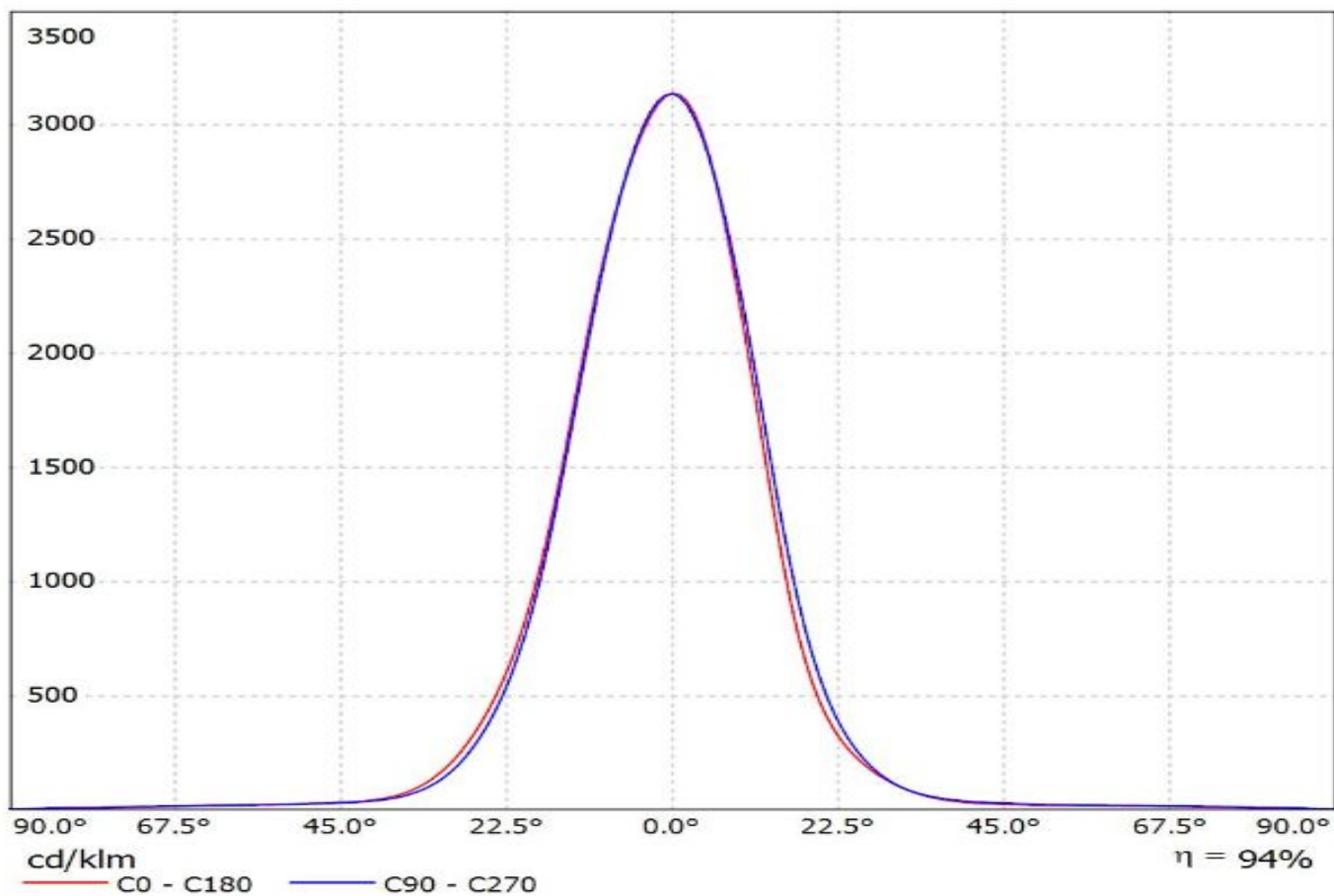

Luminaire: Ledil CS14891_HB-IP-2X6-M_(XP-G3)

Lamps: 1 x Cree_XP-G3_6x2_(XPGDWT-B1-6C1-S3-0-01)_1521.26lm@250mA_P=8.253W_I=0.25A

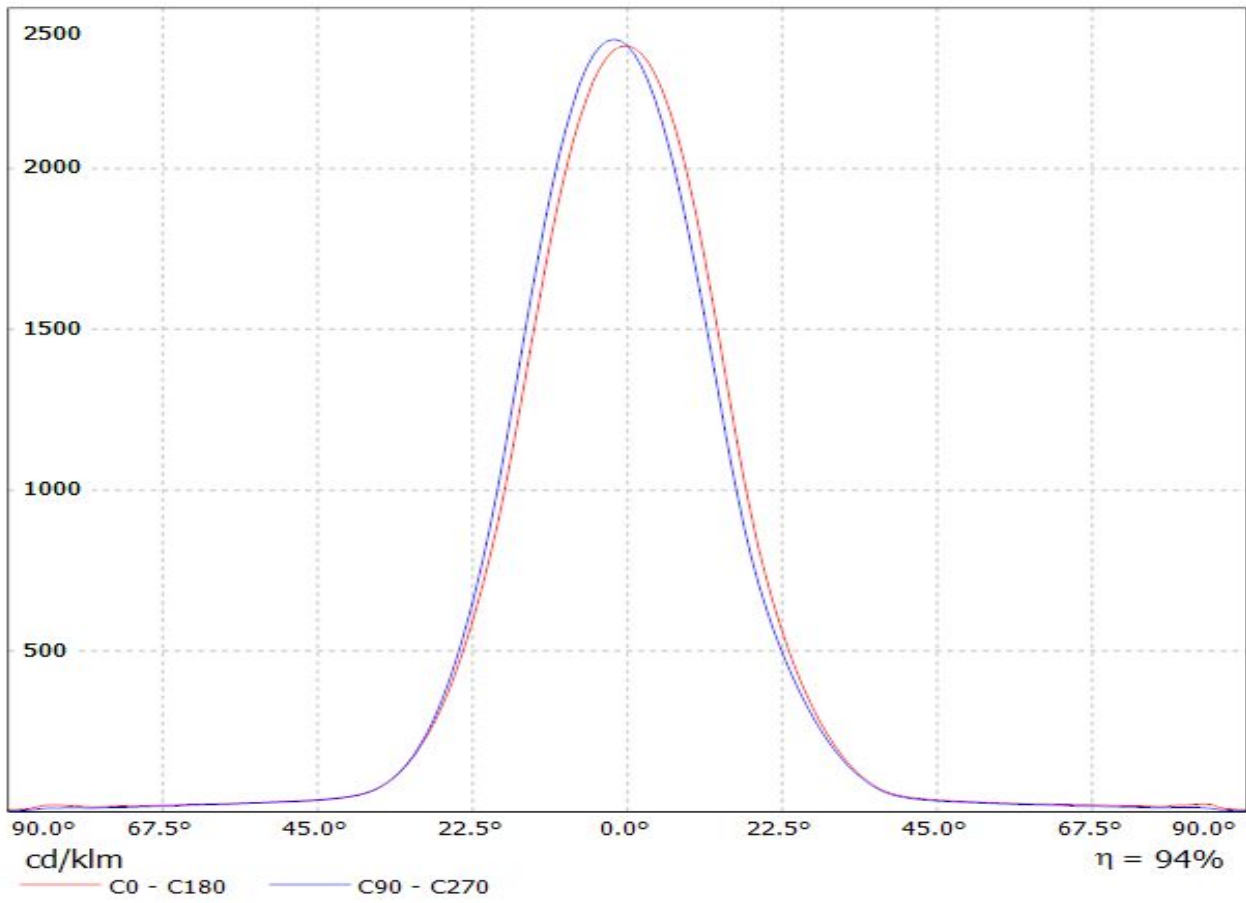

Luminaire: LEDiL Oy CS14891_HB-IP-2X6-M_(XP-L)

Lamps: 1 x Cree_XP-L_(XPLAWT-0-7A3-U50-0H-0001)_1258.85lm@250mA_P=8.27562W_I=0.250A

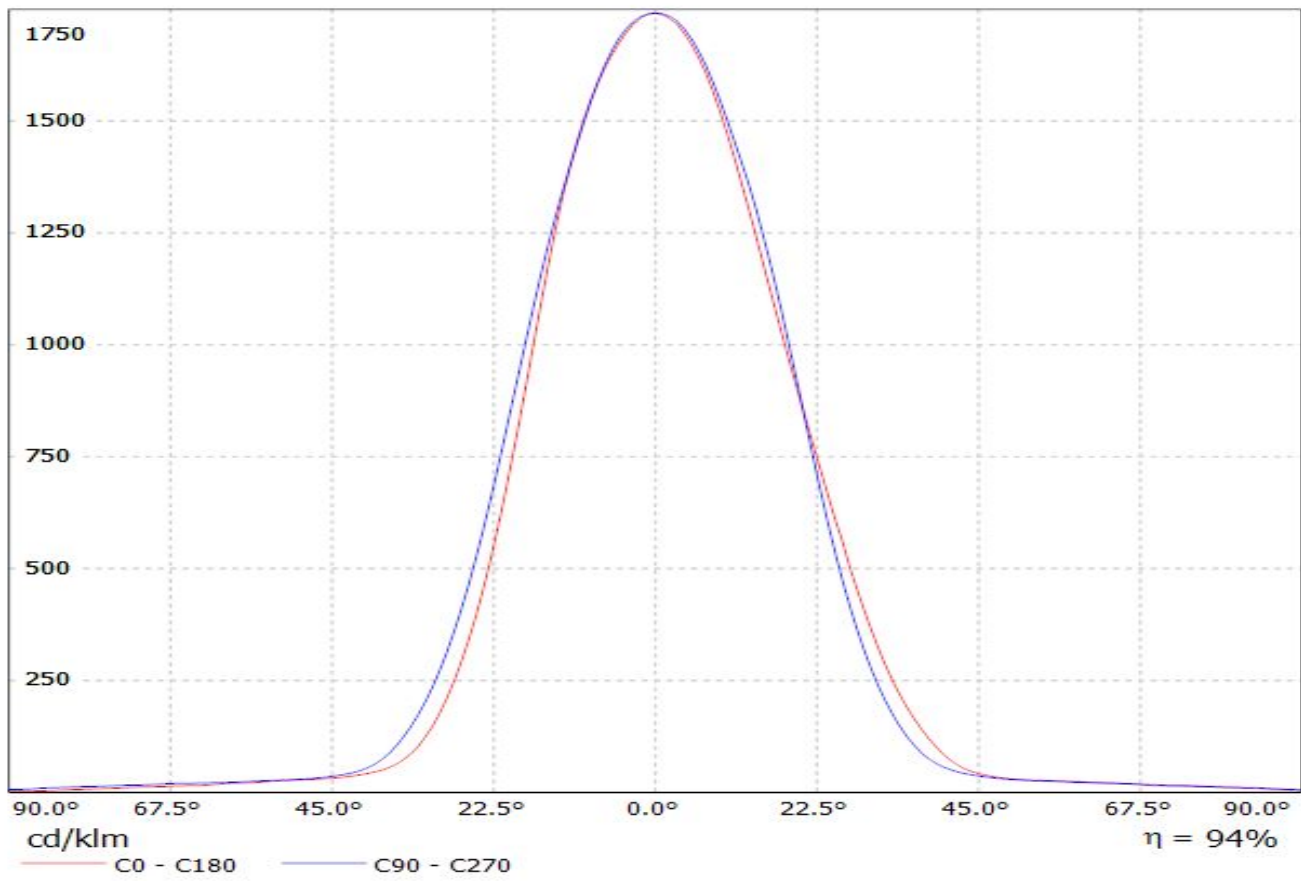

Luminaire: Ledil CS14891_HB-2X6-M_(XP-L2)
Lamps: 1 x Cree_XP-L2_2x6_1659.4lm@250mA_P=8.22525W_I=0.25A

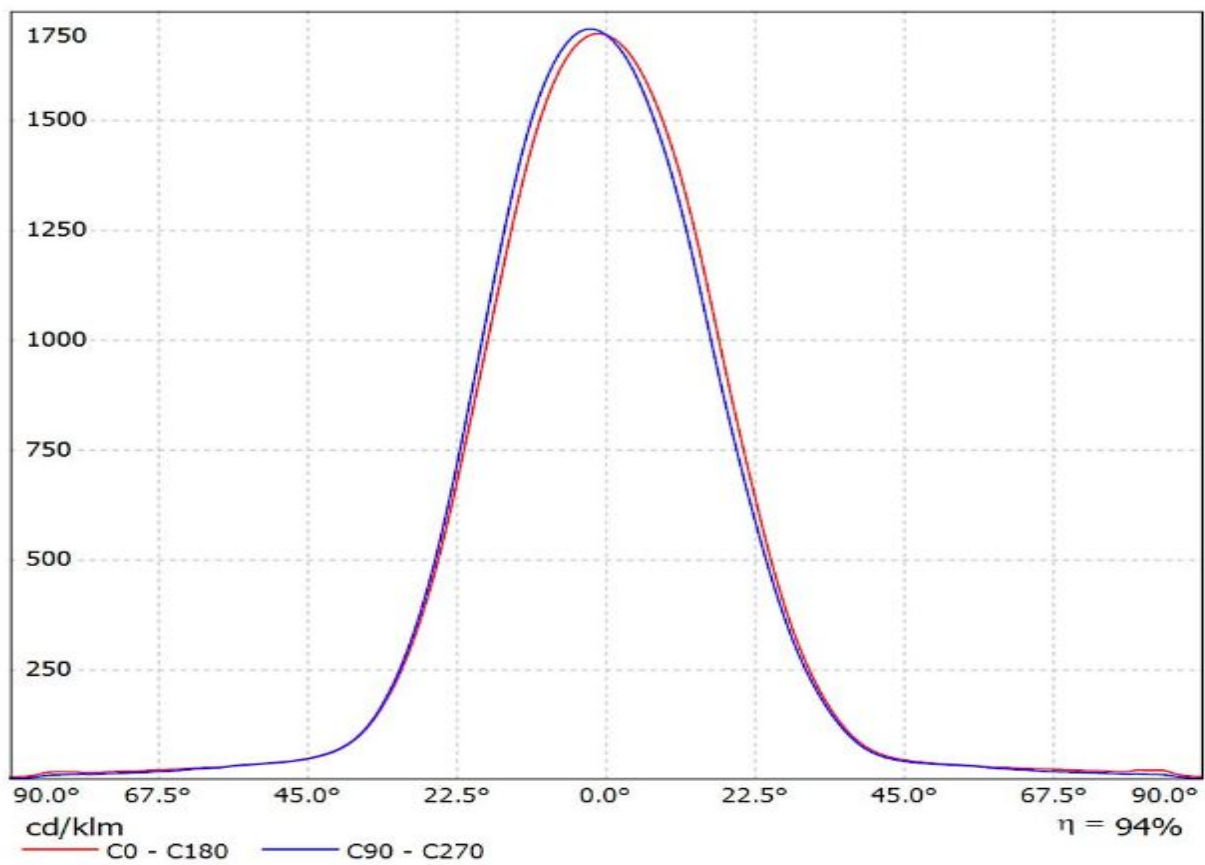

Luminaire: Ledil CS14891_HB-IP-2X6-M_(XT-E)

Lamps: 1 x Cree_XT-E_1280.48lm@250mA_P=8.94575W_I=0.250A

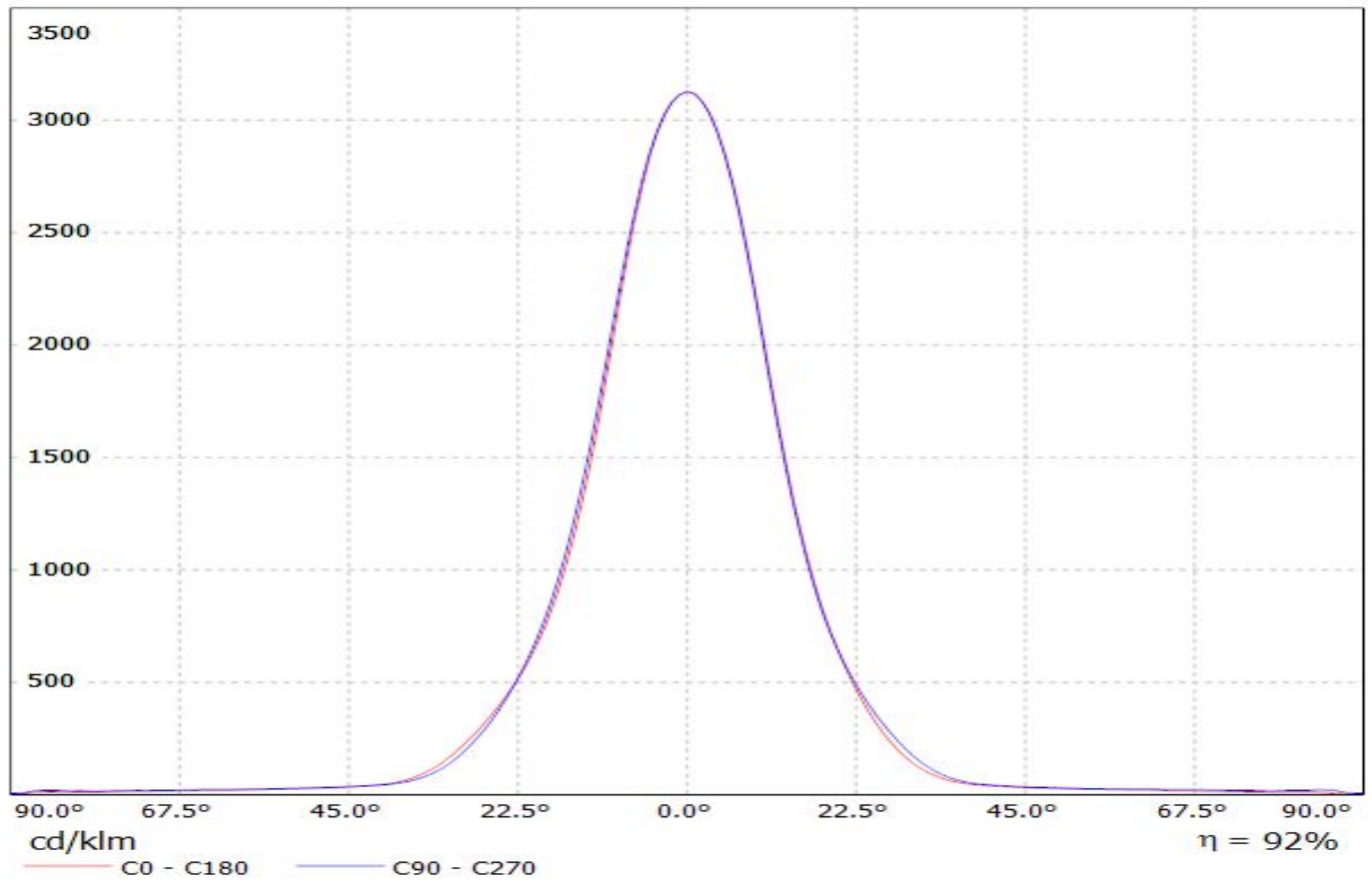

Luminaire: Ledil Oy CS14891_HB-IP-2X6-M_(H35C1)_SIMULATED
Lamps: 1 x LG H35C1

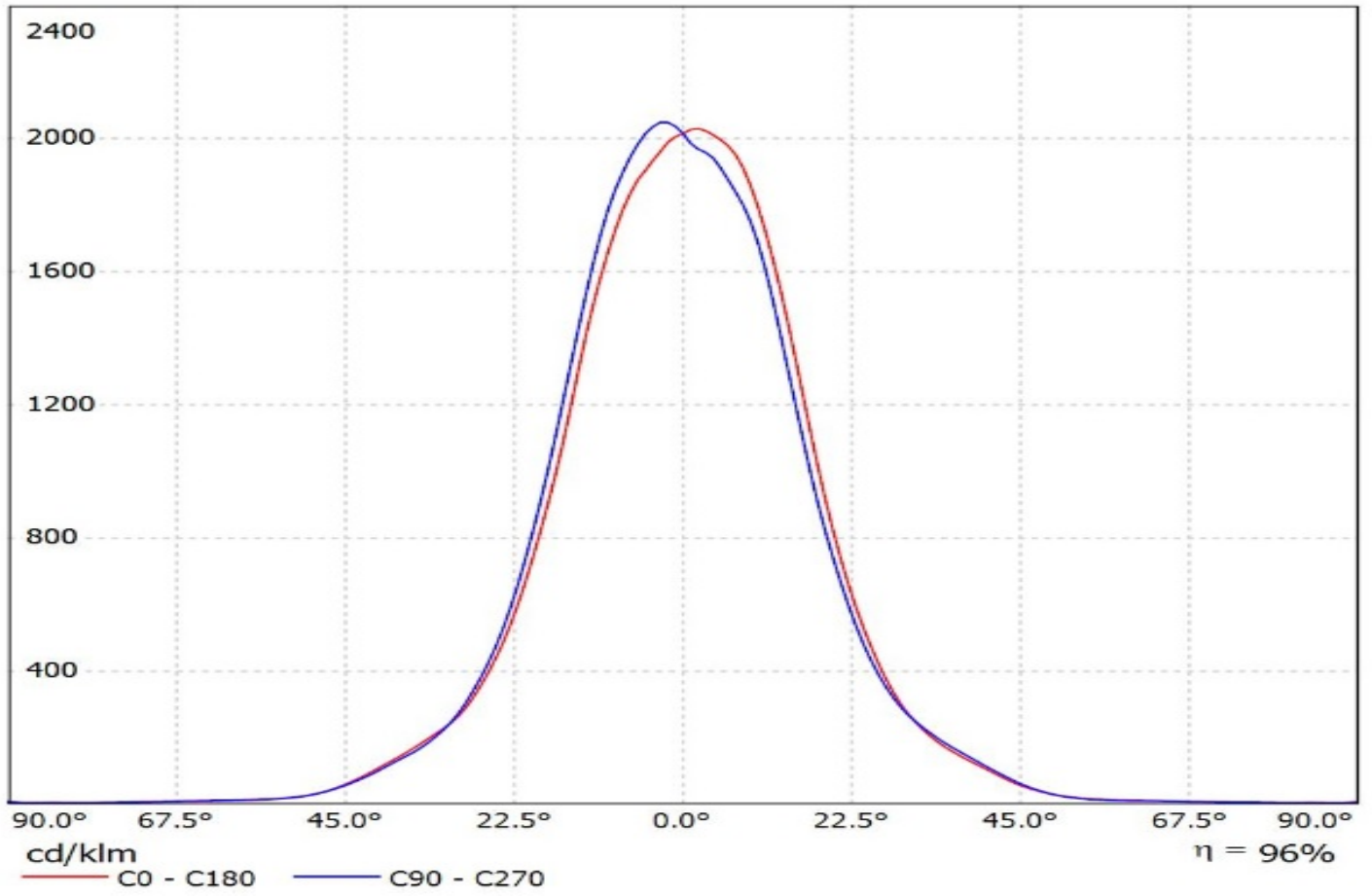

Luminaire: Ledil CS14891_HB-IP-2X6-M (Luxeon_XR-TX)
Lamps: 1 x Luxeon_XR-TX_2x6_1376.06lm@250mA_P=8.3883W_I=0.25A

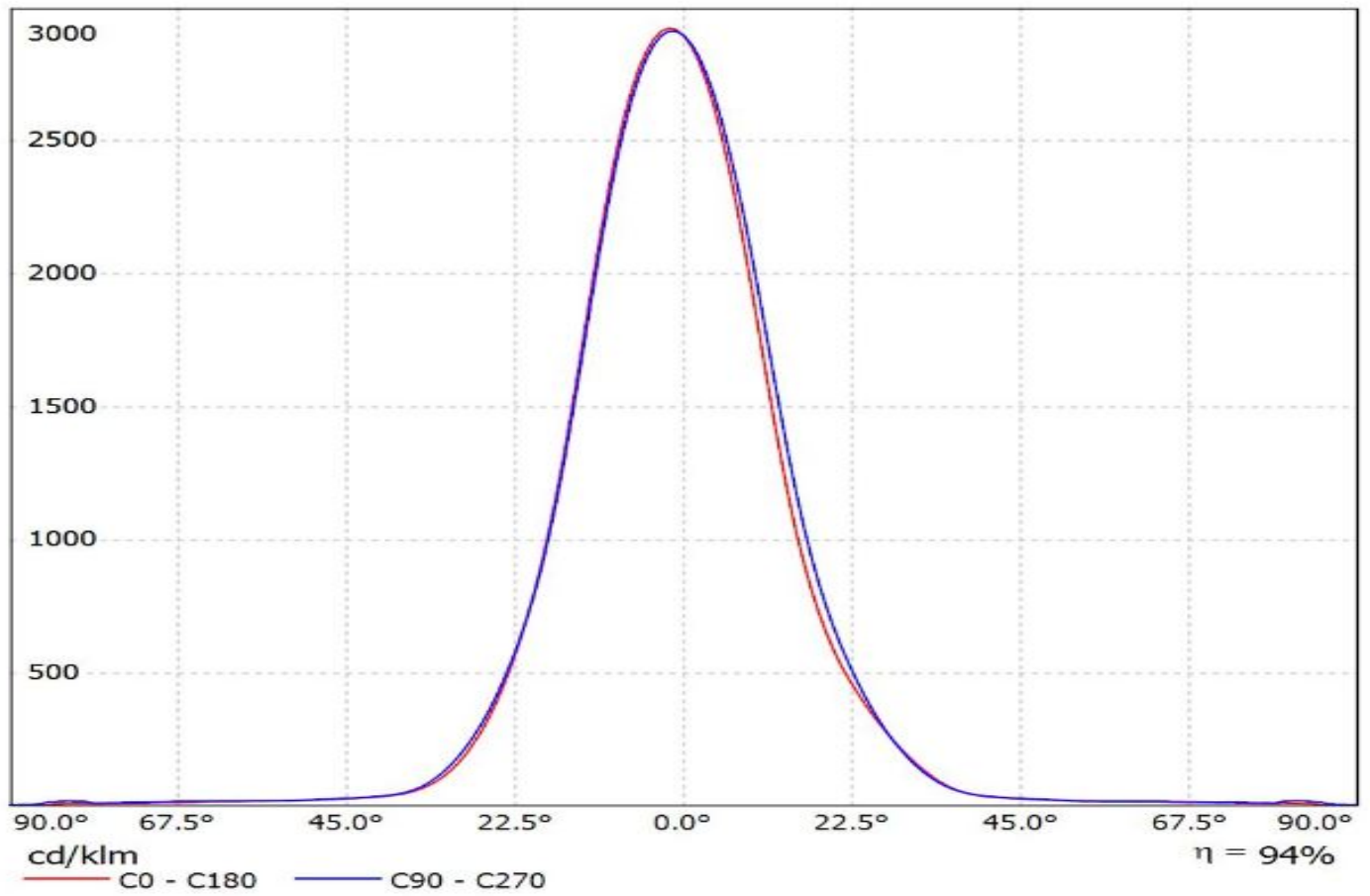

Luminaire: LEDiL Oy CS14891_HB-IP-2X6-M_(Luxeon_T)
Lamps: 1 x Luxeon_T_(LXH8-FW30)_1040.4lm@250mA_P=8.49754W_I=0.250A

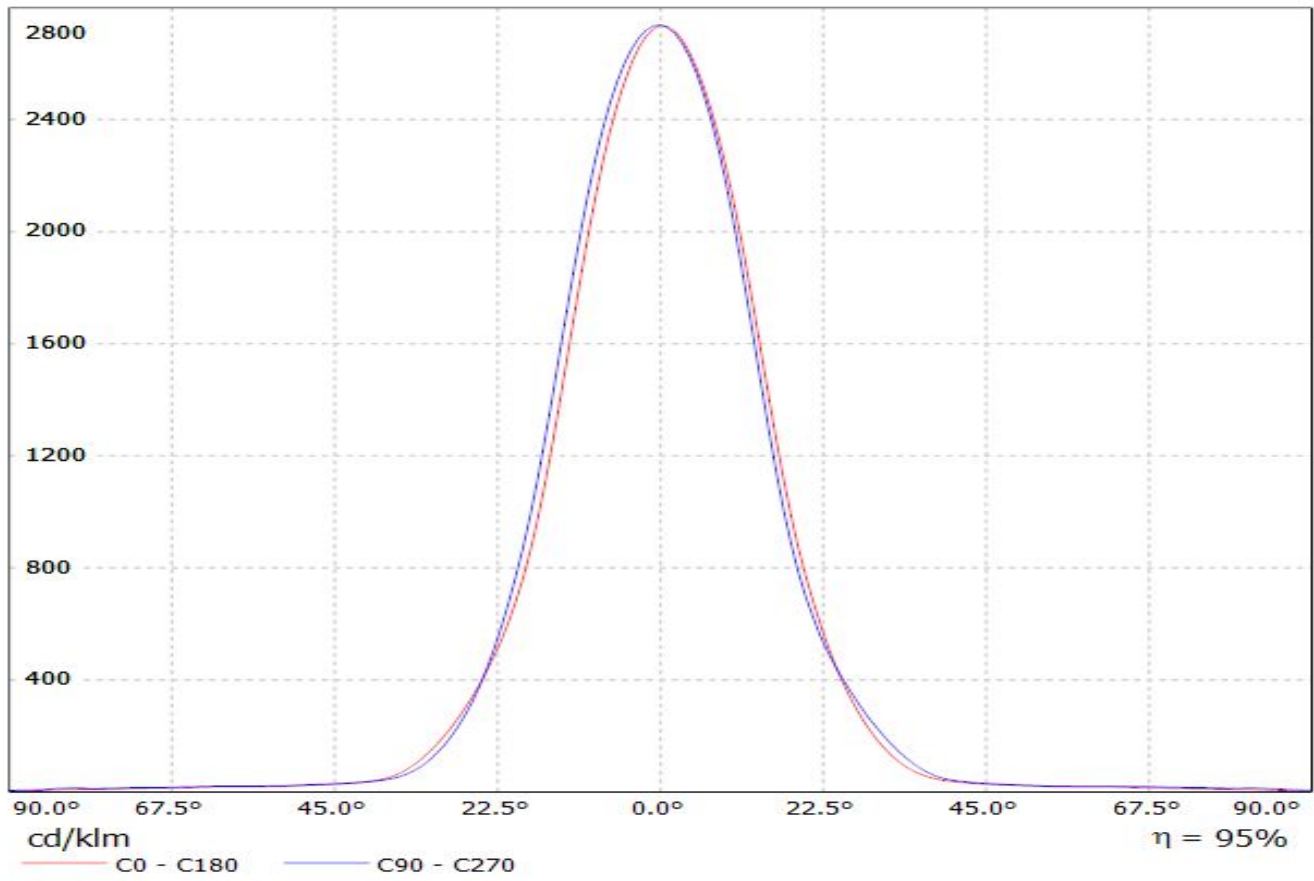

Luminaire: Ledil CS14891_HB-IP-2X6-M_(Nichia_E21)
Lamps: 1 x Nichia_NVSW21A_601.623lm@600mA_P=3.5001W_I=0.600A

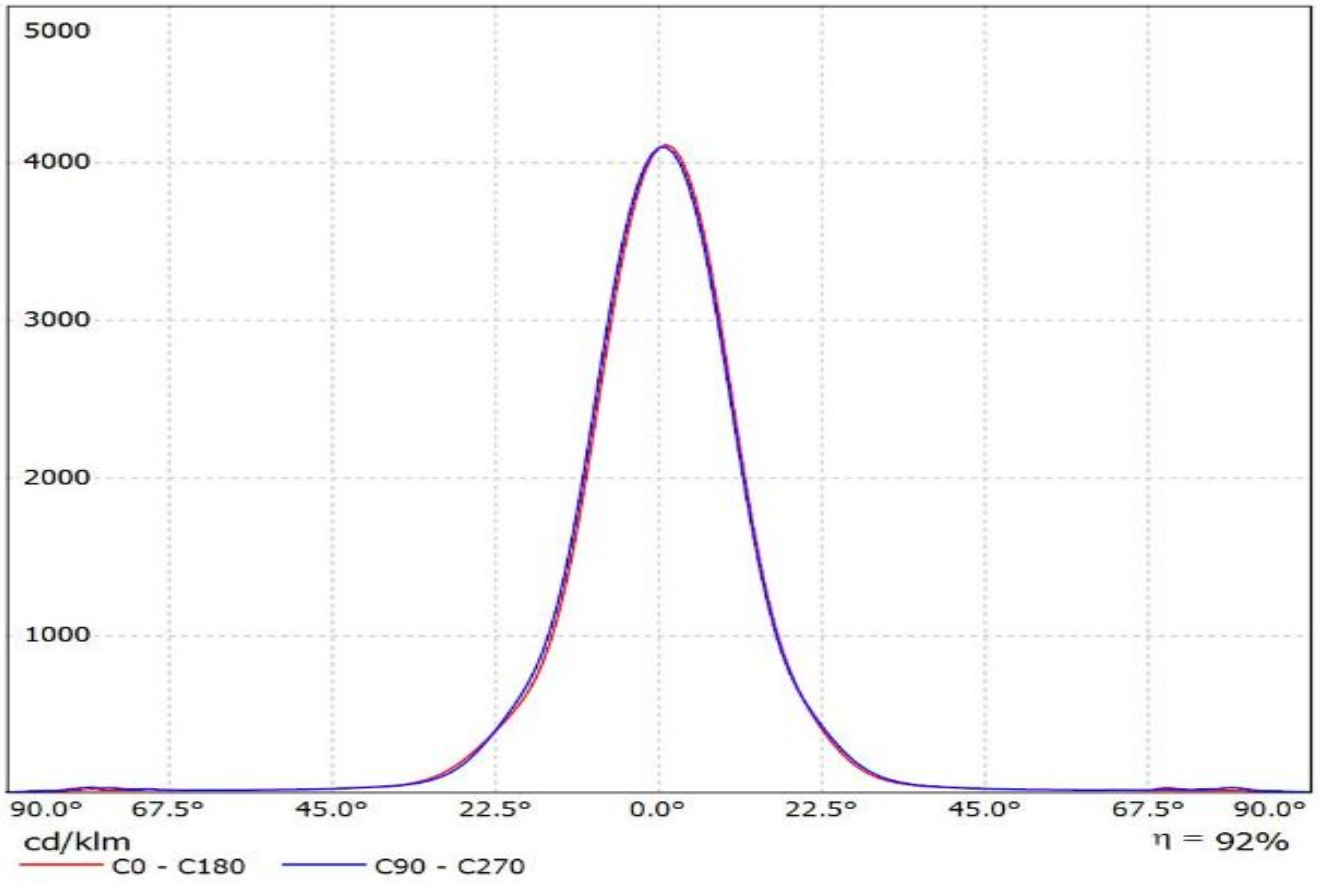

Luminaire: Ledil CS14891_HB-IP-2X6-M (SQ-PC_2X6)_C1
Lamps: 1 x Oslon_SQ-PC_2X6_1253.97lm@250mA_P=8.87825W_I=0.25A

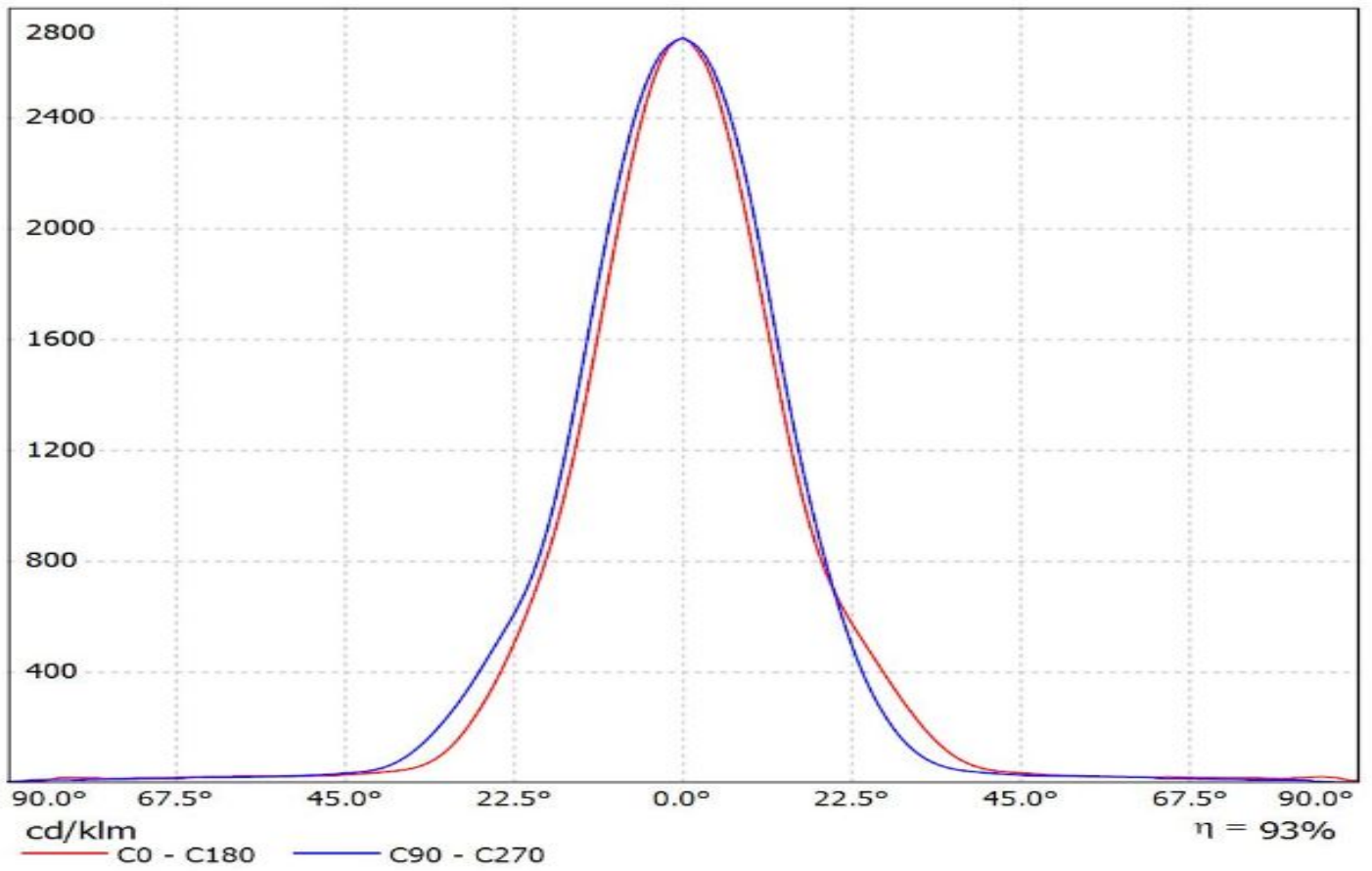

Luminaire: Ledil CS14891_HB-IP-2X6-M_(Z5M1)

Lamps: 1 x Seoul Z5M1 (SZ5-M1-WW-C8)_1201.44lm@250mA_P=8.63825W_I=0.25A

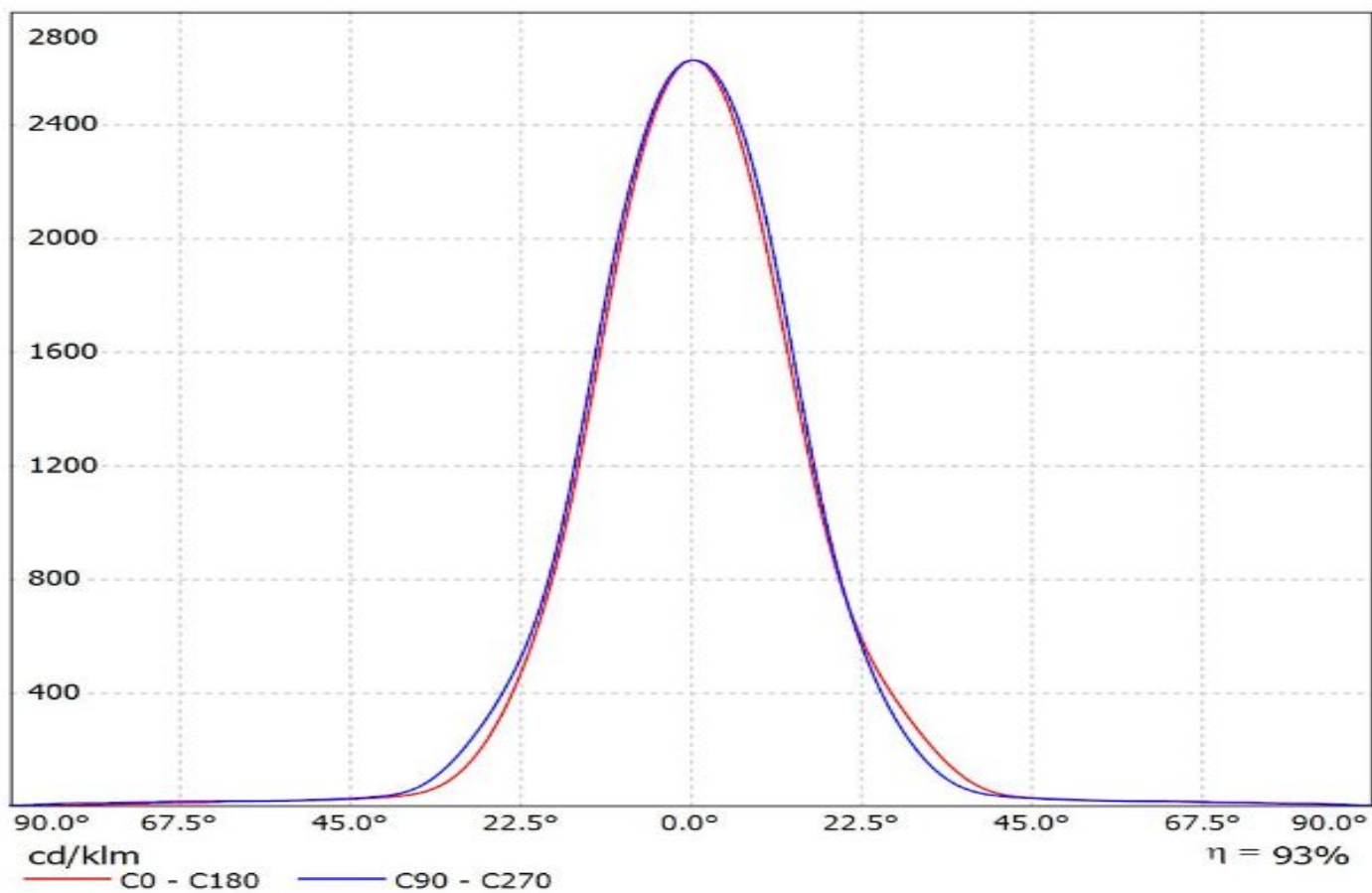

Luminaire: Ledil CS14891_HB-IP-2X6-M_(Z8Y22_PLUS)

Lamps: 1 x Seoul_Z8Y22_PLUS_2X6_(SZ8-Y22-W0-C7P)1489.65lm@250mA_P=8.30675W_I=0.250A

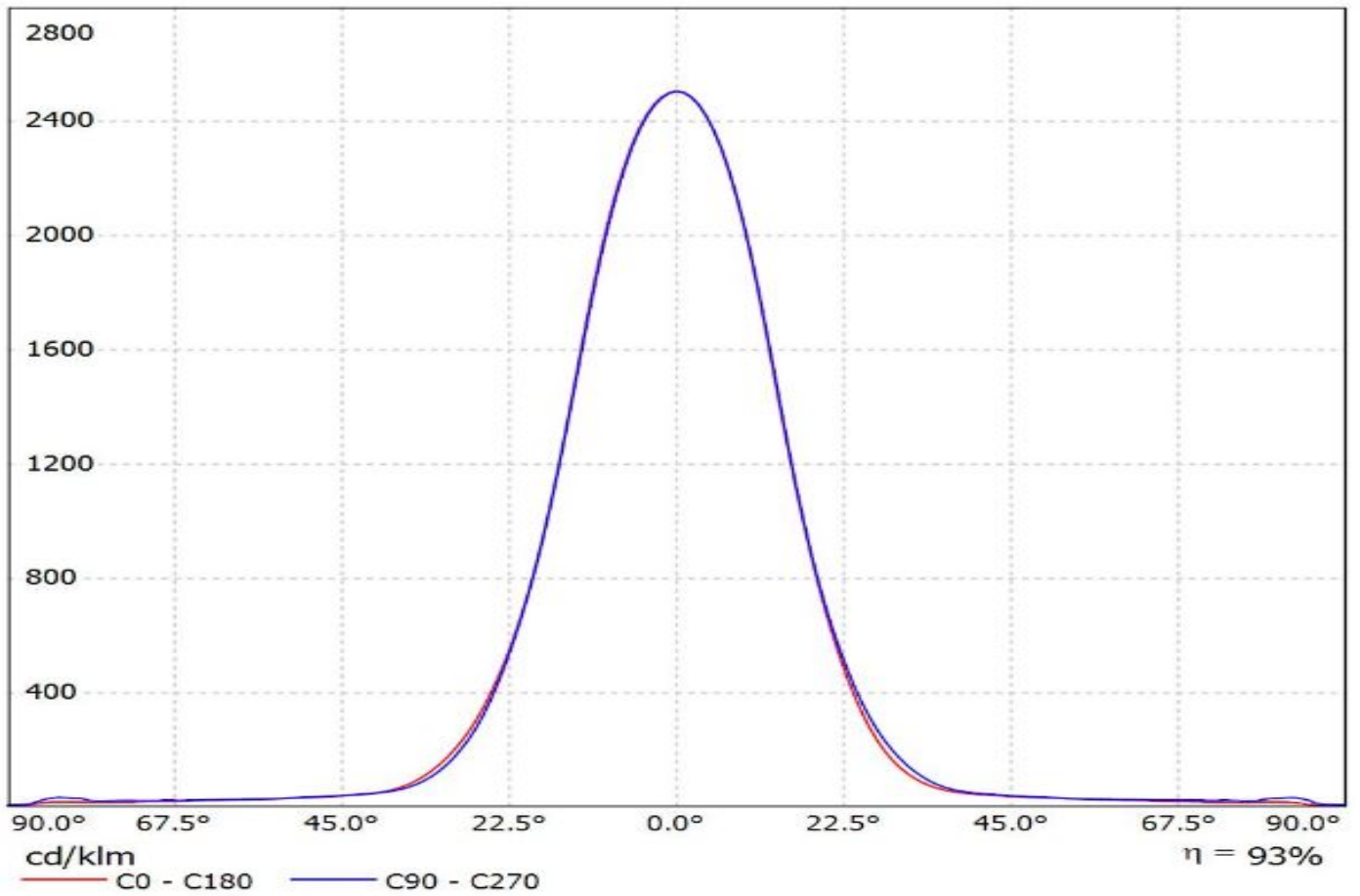

Luminaire: LEDiL Oy CS14891_HB-IP-2X6-M_(XM-L)_Cav1

Lamps: 1 x Cree_XM-L_(XMLAWT-00-0000-000LT2OE7)_985.421lm@250mA_P=8.11375W_I=0.2499A

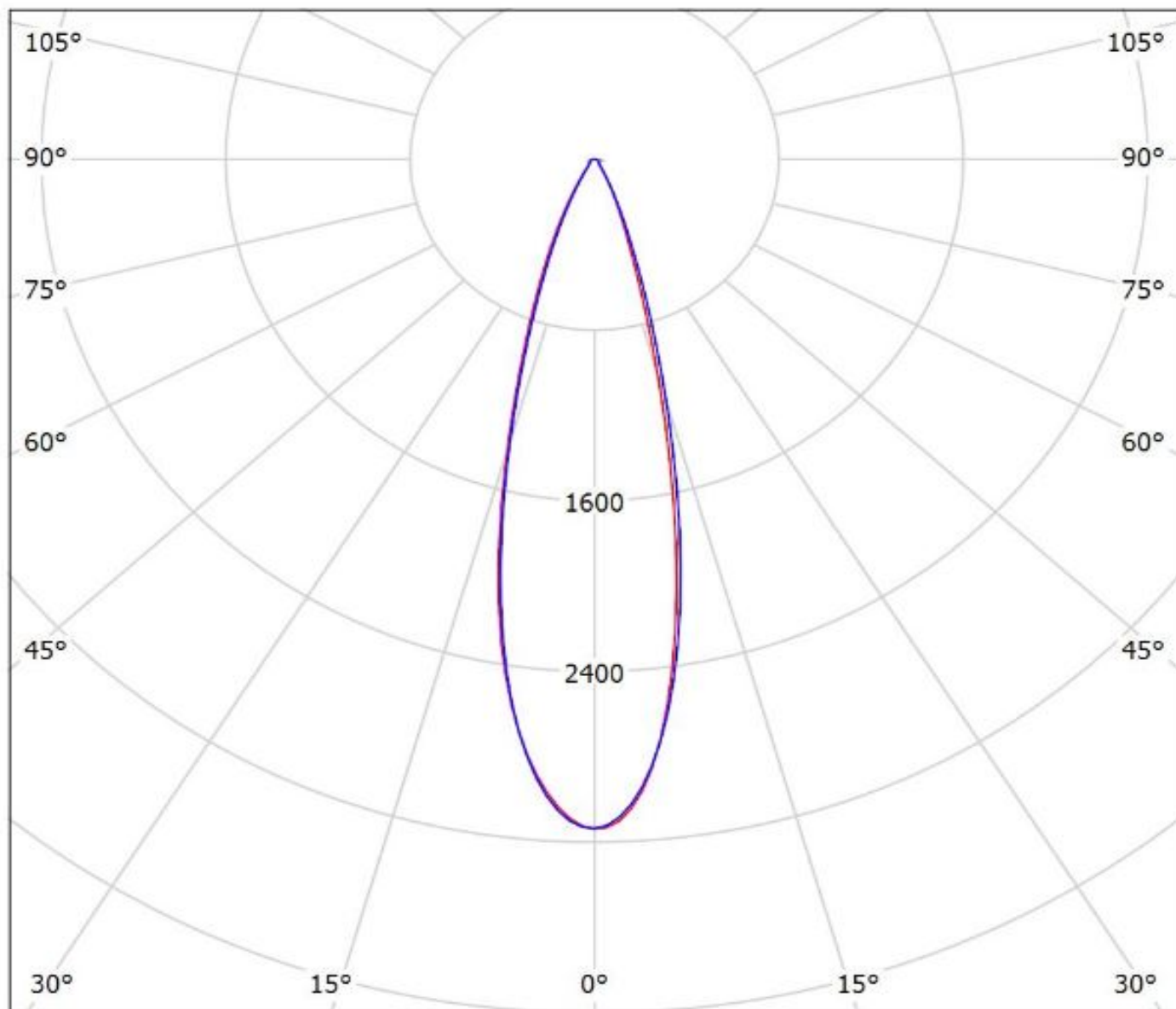

cd/klm

— C0 - C180

— C90 - C270

$\eta = 94\%$

Luminaire: Ledil CS14891_HB-IP-2X6-M_(XP-G3)

Lamps: 1 x Cree_XP-G3_6x2_(XPGDWT-B1-6C1-S3-0-01)_1521.26lm@250mA_P=8.253W_η=0.25A

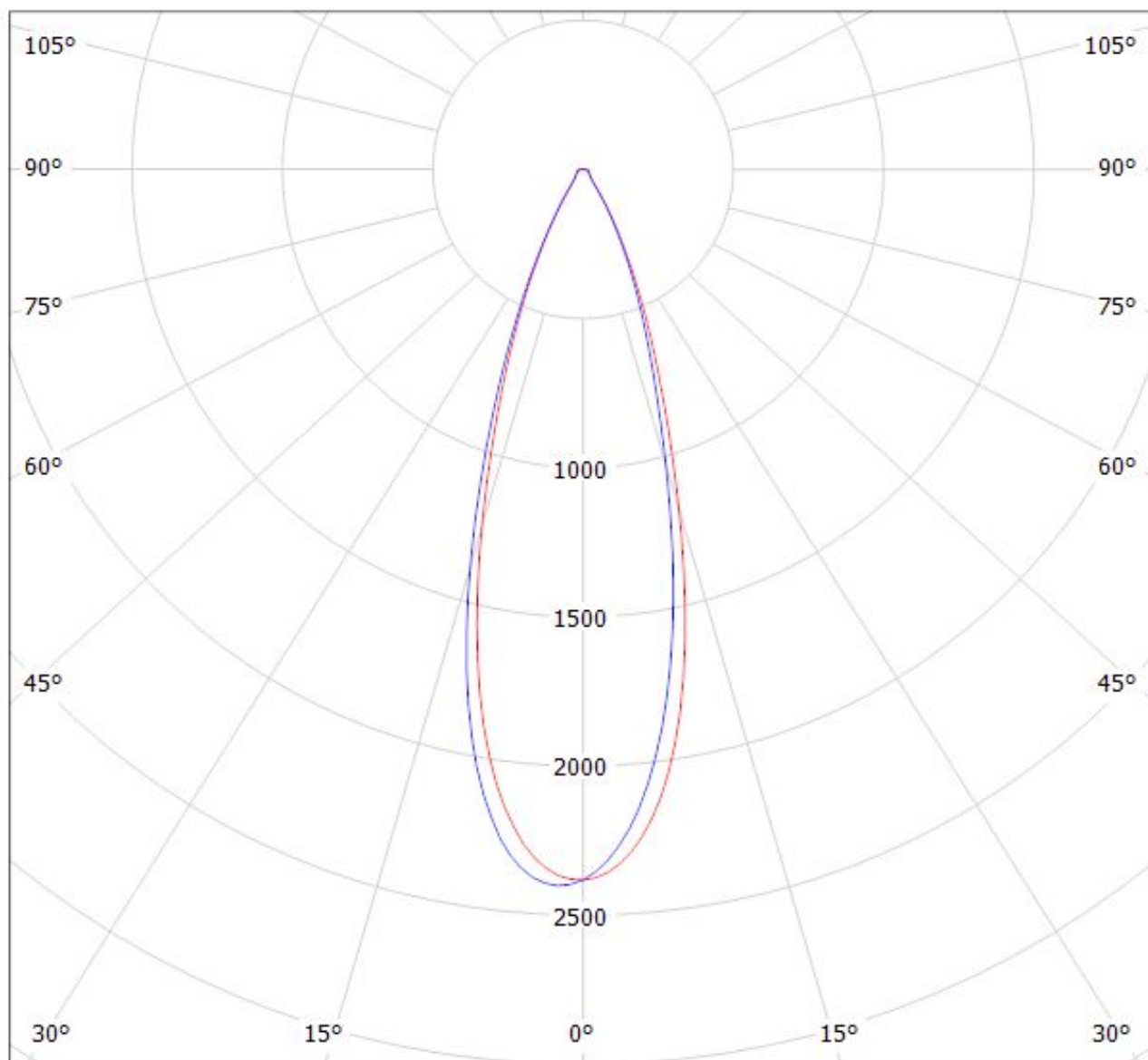

cd/klm

— C0 - C180

— C90 - C270

$\eta = 94\%$

Luminaire: LEDiL Oy CS14891_HB-IP-2X6-M_(XP-L)

Lamps: 1 x Cree_XP-L_(XPLAWT-0-7A3-U50-0H-0001)_1258.85lm@250mA_P=8.27562W_I=0.250A

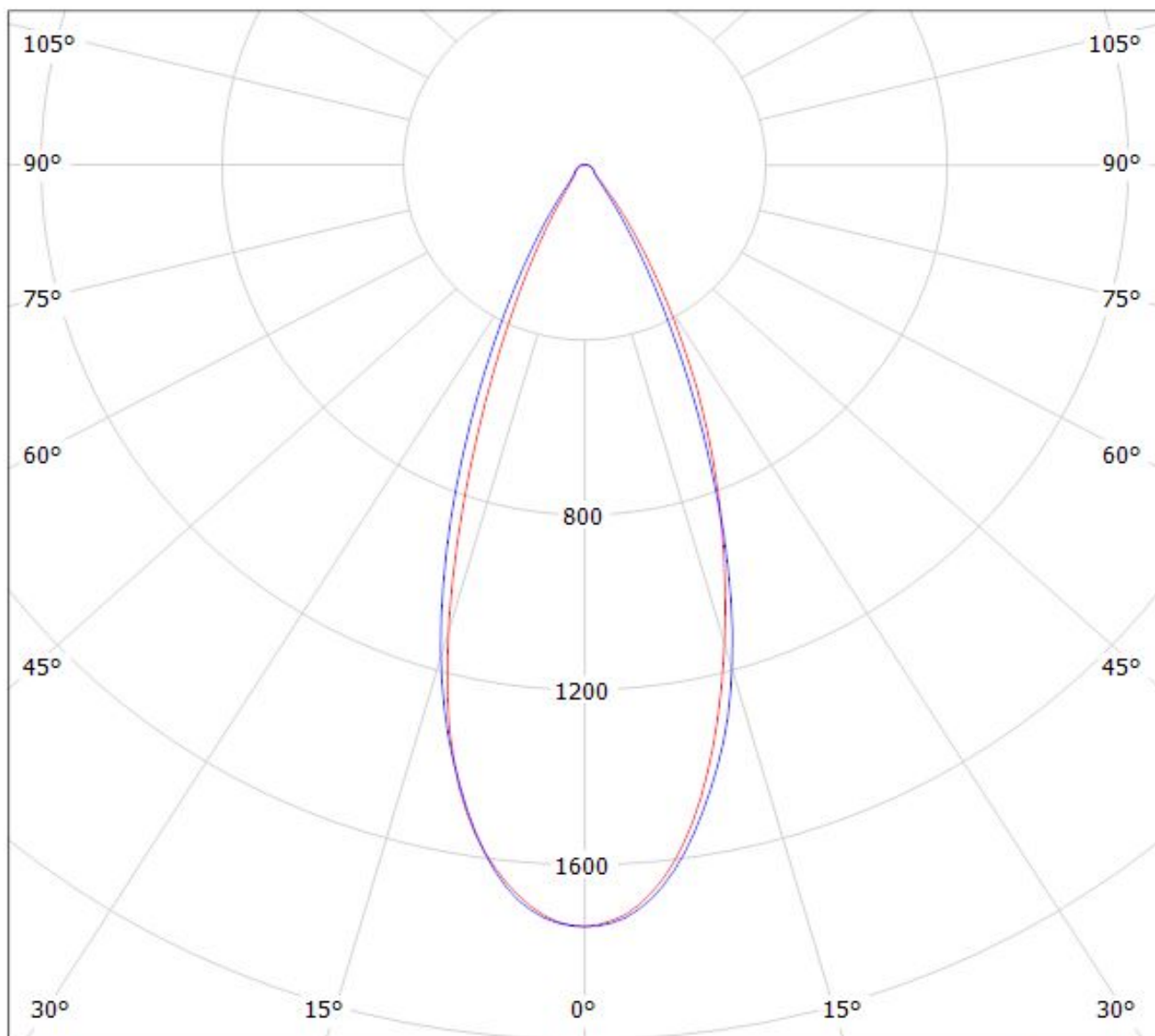

cd/klm

— C0 - C180

— C90 - C270

$\eta = 94\%$

Luminaire: Ledil CS14891_HB-2X6-M_(XP-L2)

Lamps: 1 x Cree_XP-L2_2x6_1659.4lm@250mA_P=8.22525W_I=0.25A

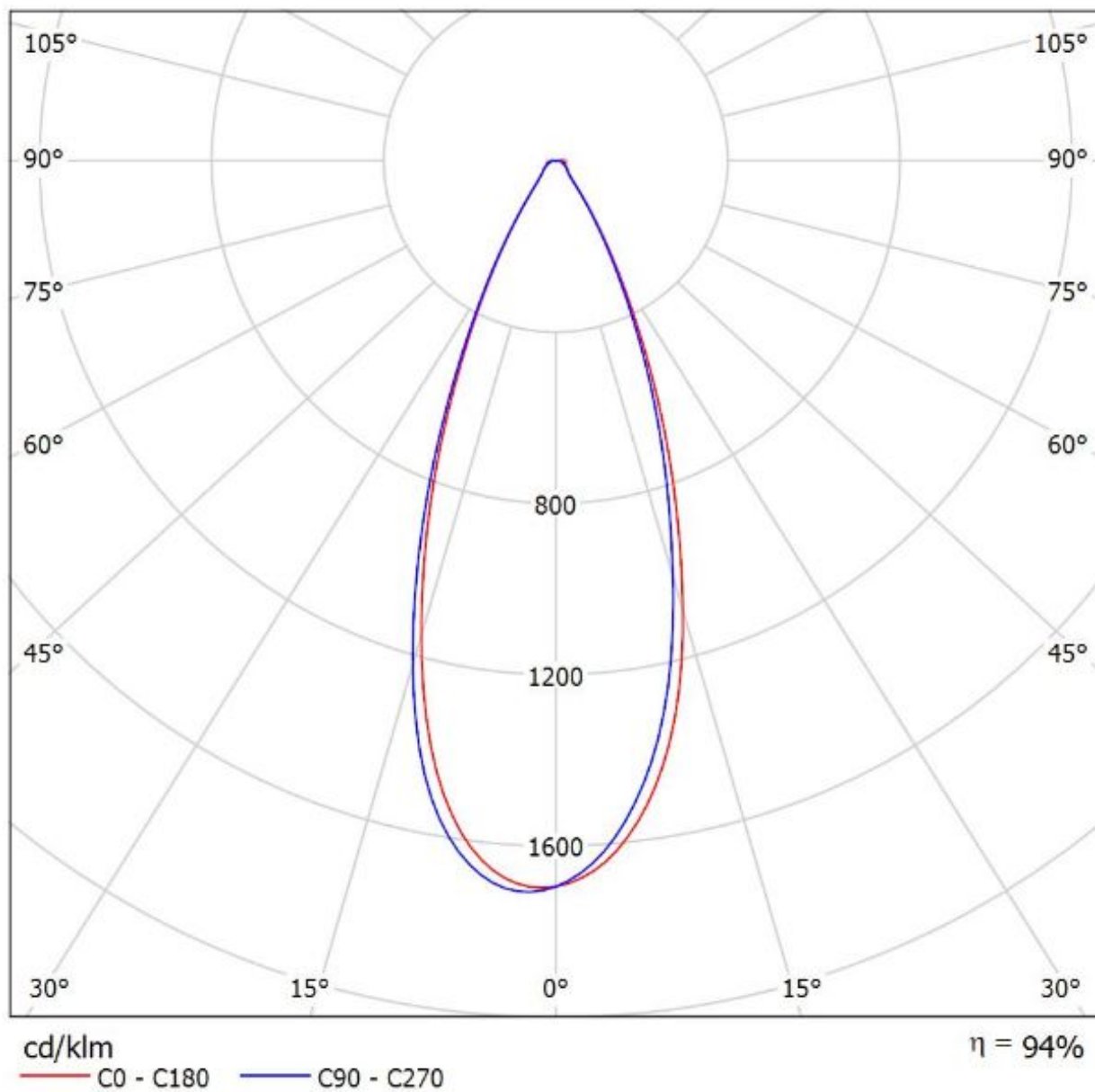

Luminaire: Ledil CS14891_HB-IP-2X6-M_(XT-E)

Lamps: 1 x Cree_XT-E_1280.48lm@250mA_P=8.94575W_I=0.250A

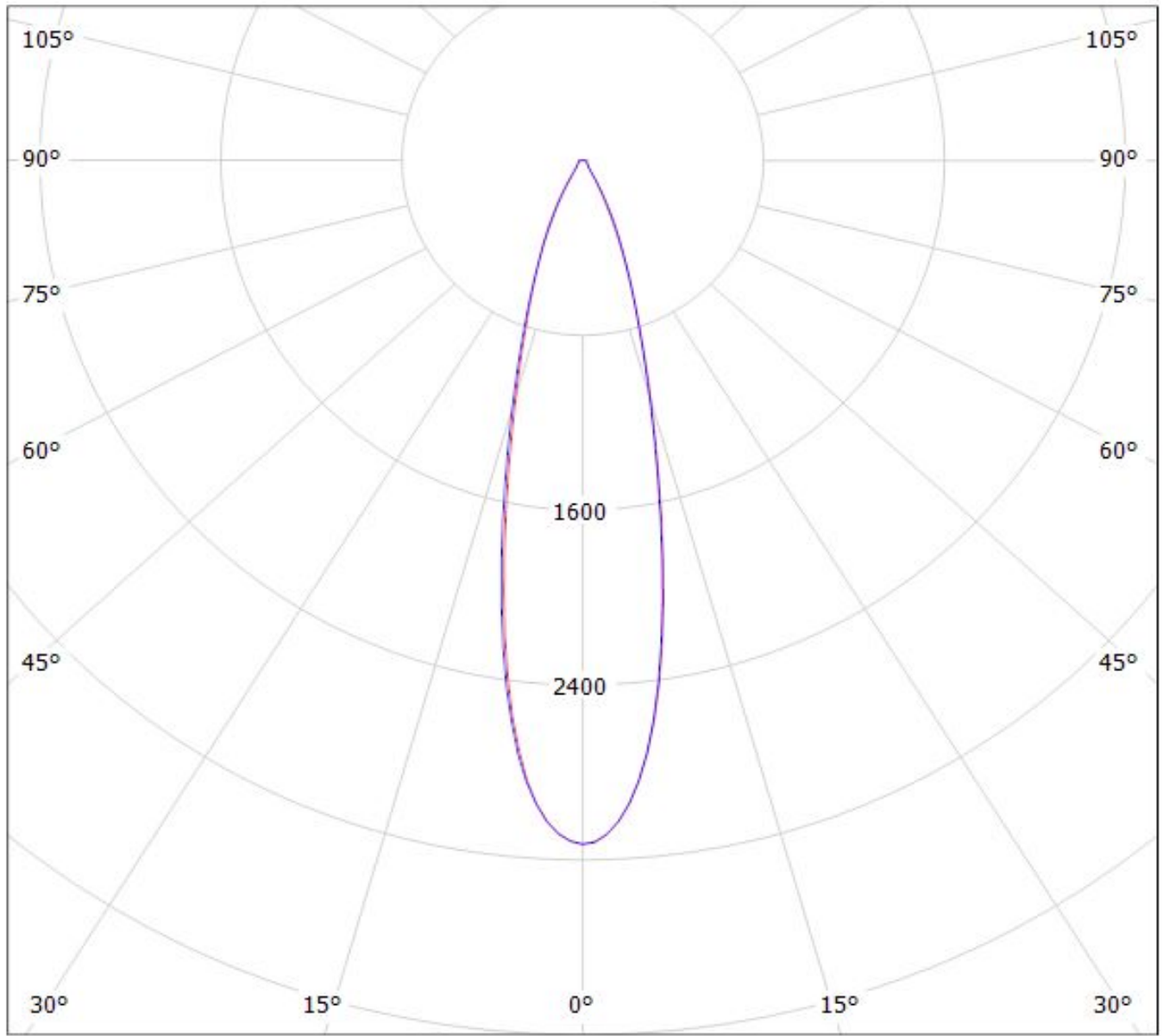

cd/klm

$\eta = 92\%$

— C0 - C180 — C90 - C270

Luminaire: Ledil Oy CS14891_HB-IP-2X6-M_(H35C1)_SIMULATED
Lamps: 1 x LG H35C1

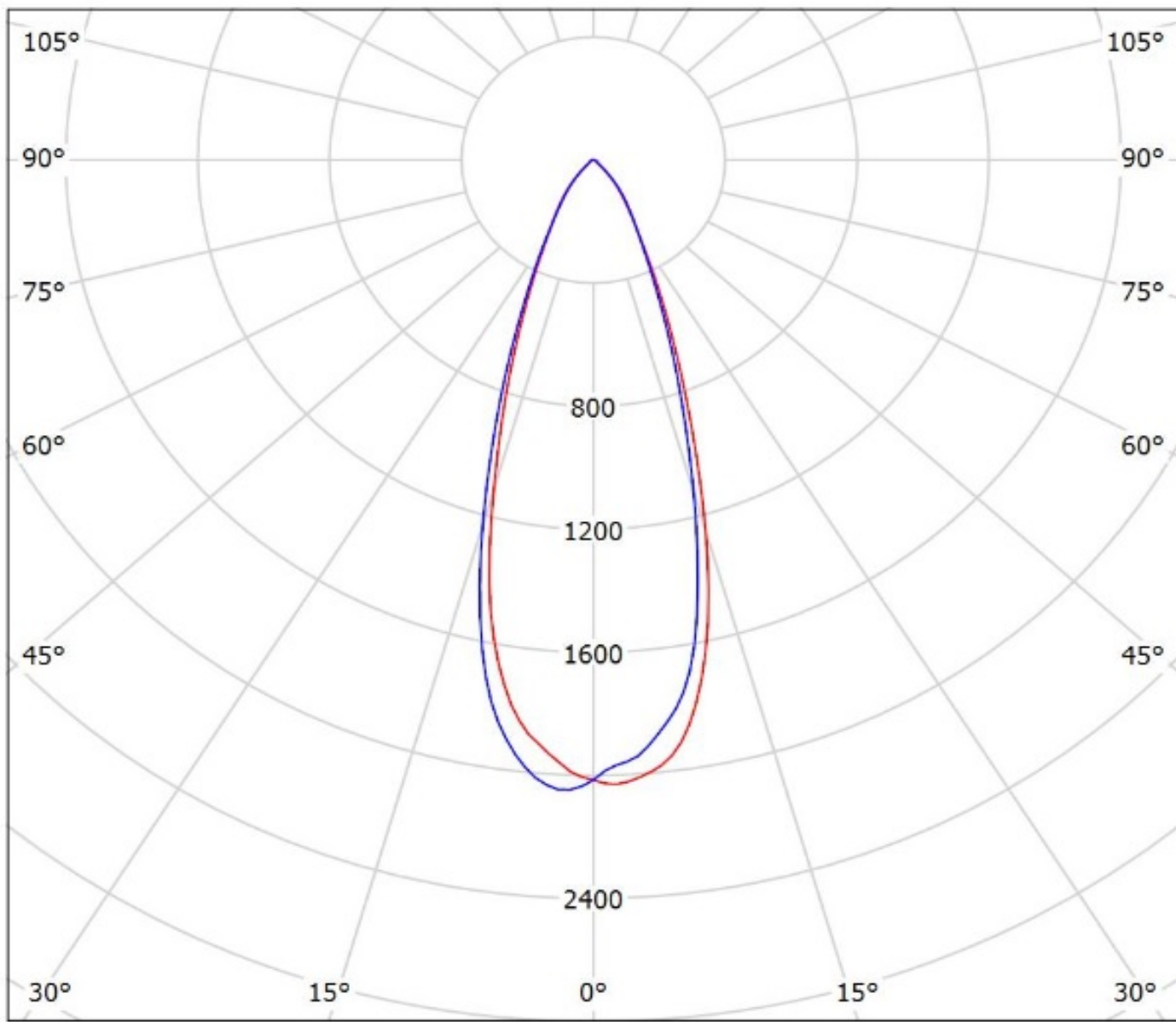

cd/klm

— C0 - C180 — C90 - C270

$\eta = 96\%$

Luminaire: Ledil CS14891_HB-IP-2X6-M_(Luxeon_XR-TX)

Lamps: 1 x Luxeon_XR-TX_2x6_1376.06lm@250mA_P=8.3883W_I=0.25A

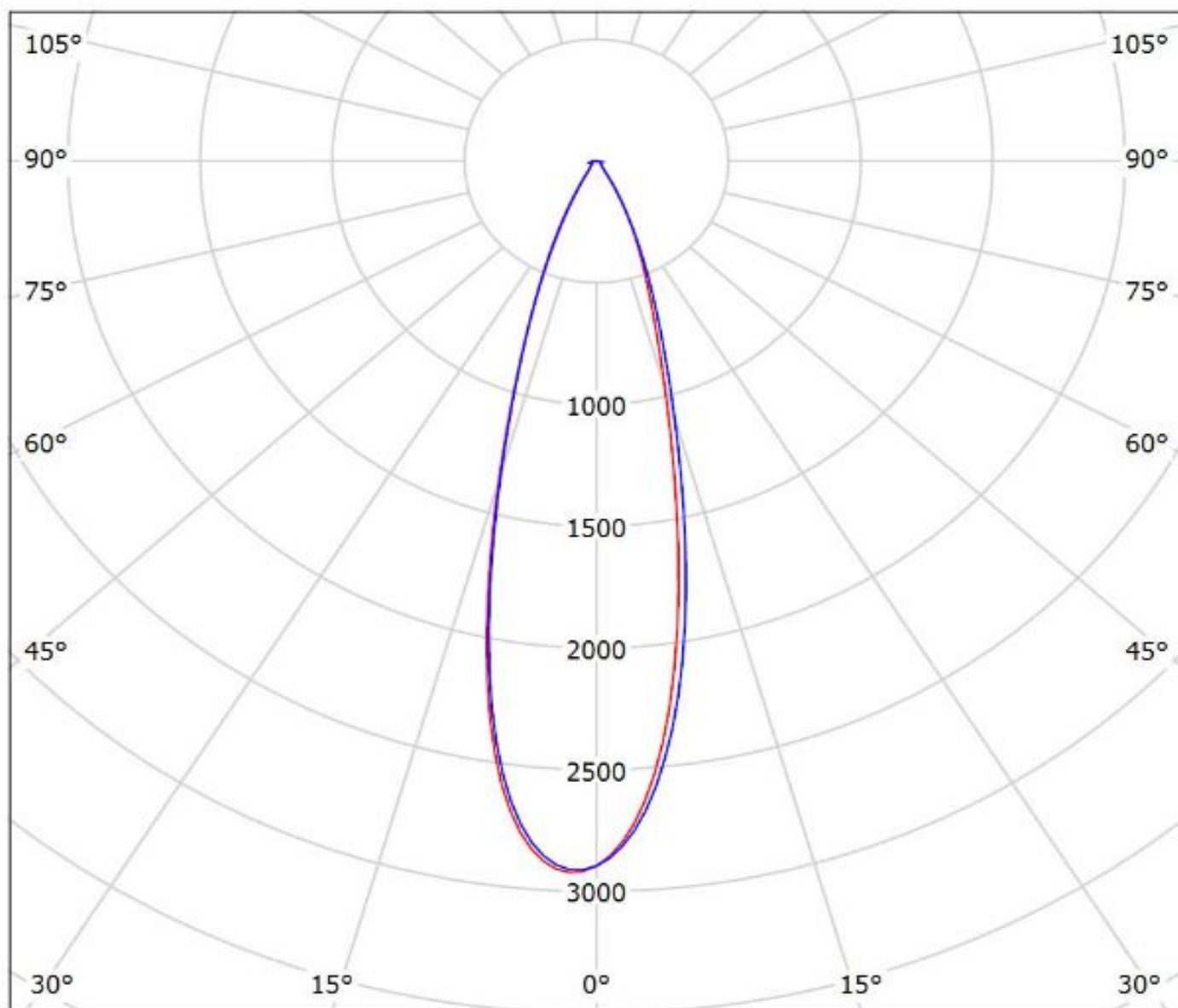

cd/klm

— C0 - C180

— C90 - C270

$\eta = 94\%$

Luminaire: LEDiL Oy CS14891_HB-IP-2X6-M_(Luxeon_T)

Lamps: 1 x Luxeon_T_(LXH8-FW30)_1040.4lm@250mA_P=8.49754W_I=0.250A

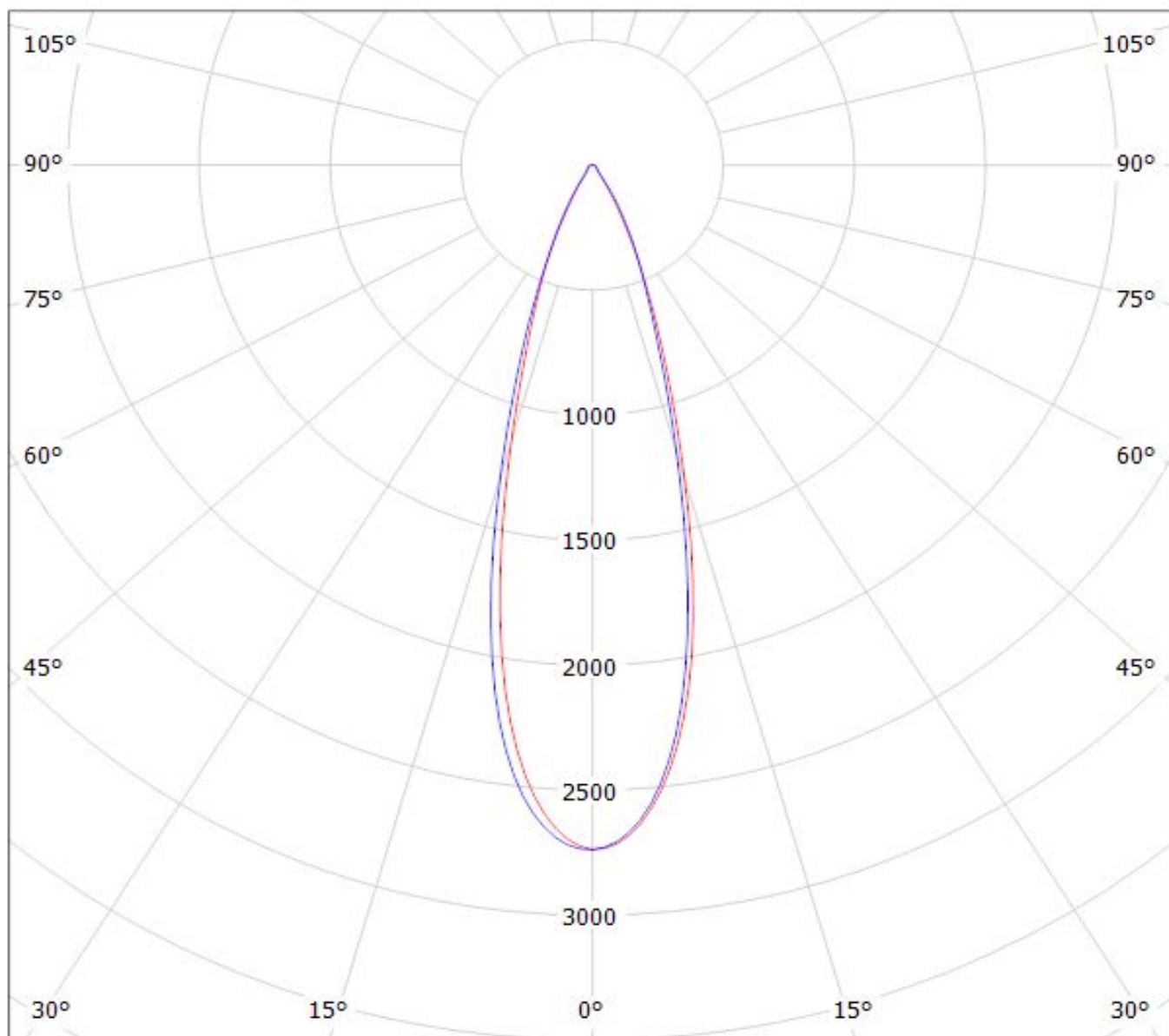

cd/klm

$\eta = 95\%$

— C0 - C180 — C90 - C270

Luminaire: Ledil CS14891_HB-IP-2X6-M_(Nichia_E21)

Lamps: 1 x Nichia_NVSWE21A_601.623lm@600mA_P=3.5001W_I=0.600A

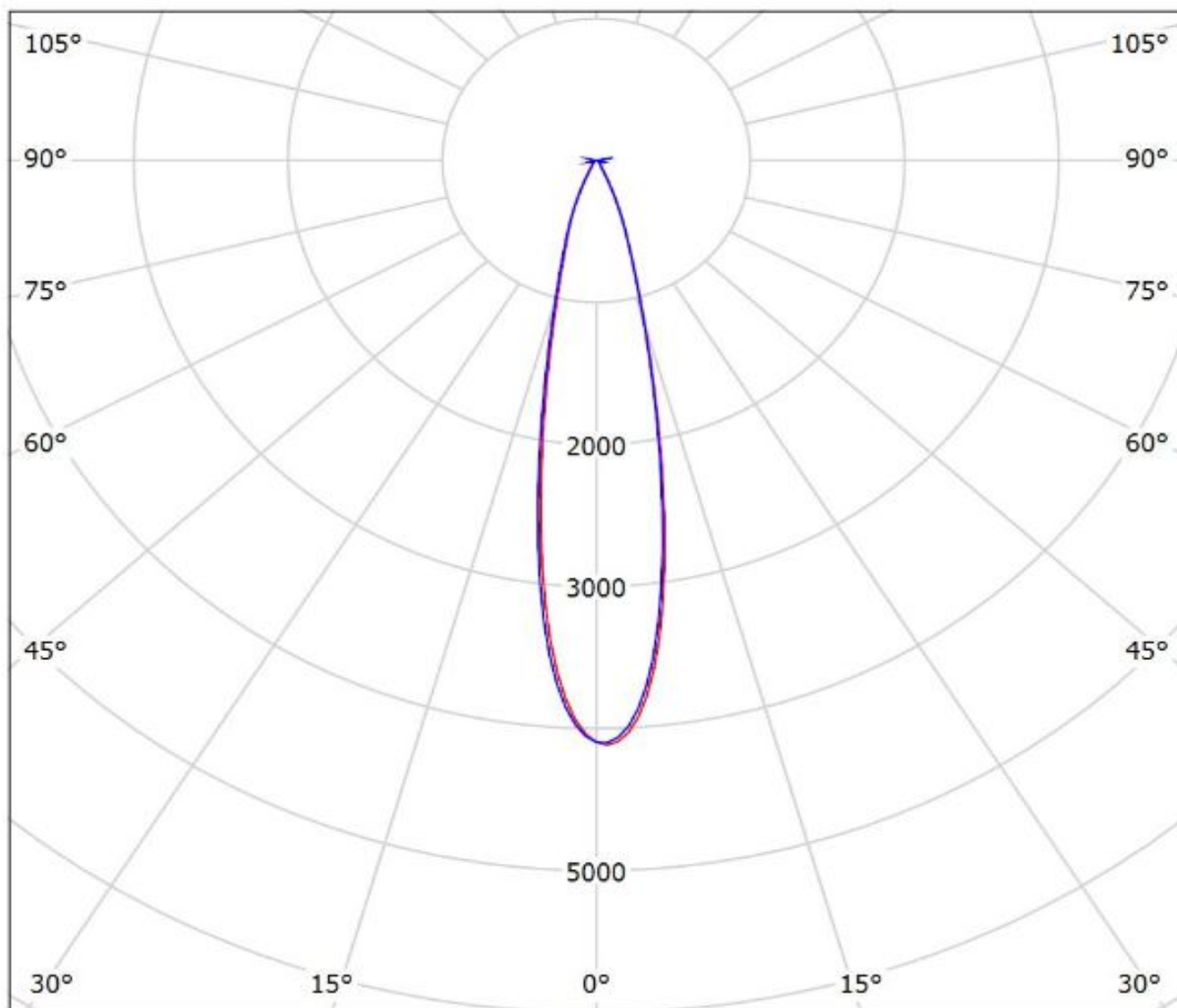

cd/klm

— C0 - C180 — C90 - C270

$\eta = 92\%$

Luminaire: Ledil CS14891_HB-IP-2X6-M_(SQ-PC_2X6)_C1

Lamps: 1 x Oslon_SQ-PC_2X6_1253.97lm@250mA_P=8.87825W_I=0.25A

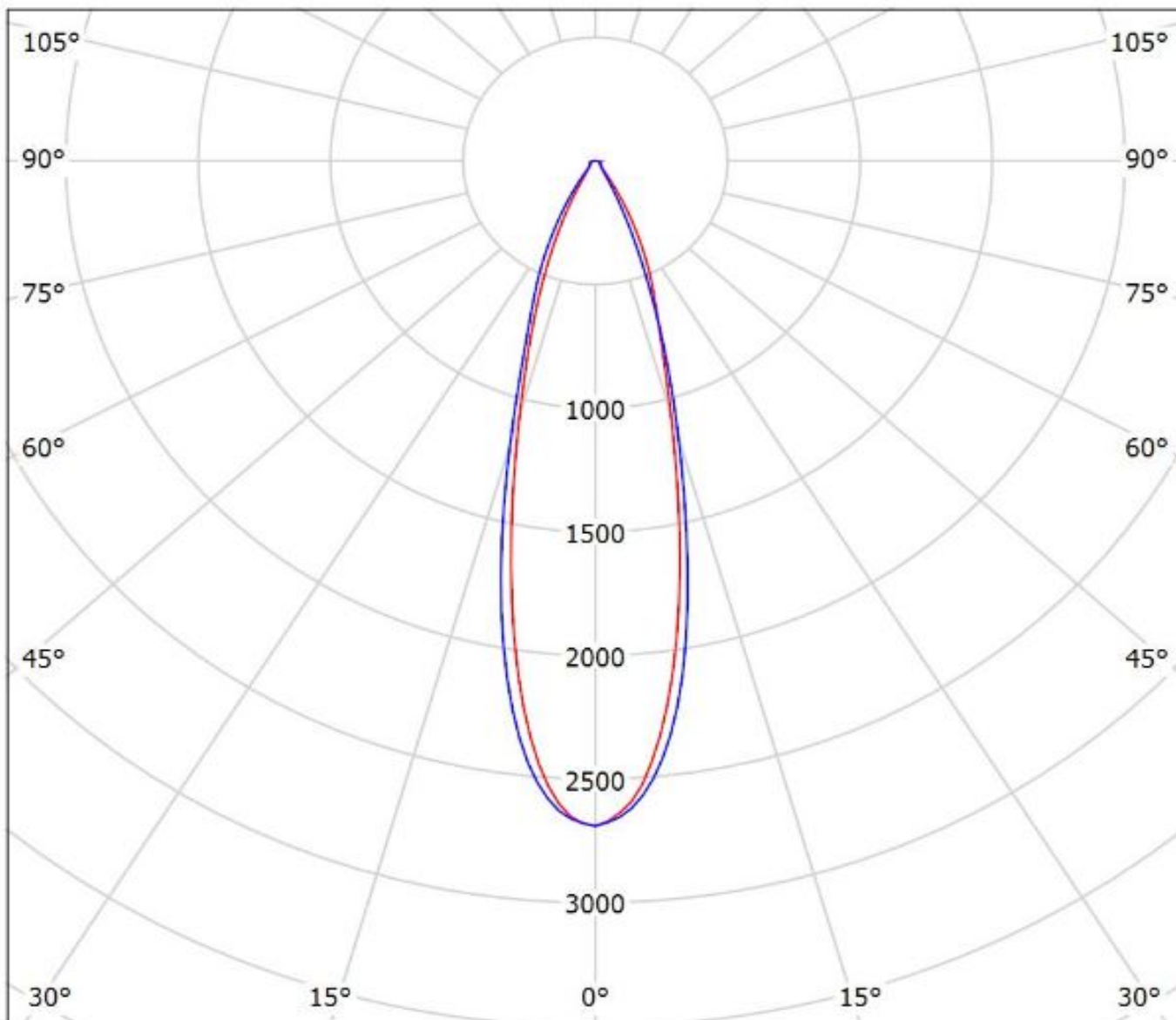

cd/klm

— C0 - C180

— C90 - C270

$\eta = 93\%$

Luminaire: Ledil CS14891_HB-IP-2X6-M_(Z5M1)

Lamps: 1 x Seoul Z5M1 (SZ5-M1-WW-C8)_1201.44lm@250mA_P=8.63825W_I=0.25A

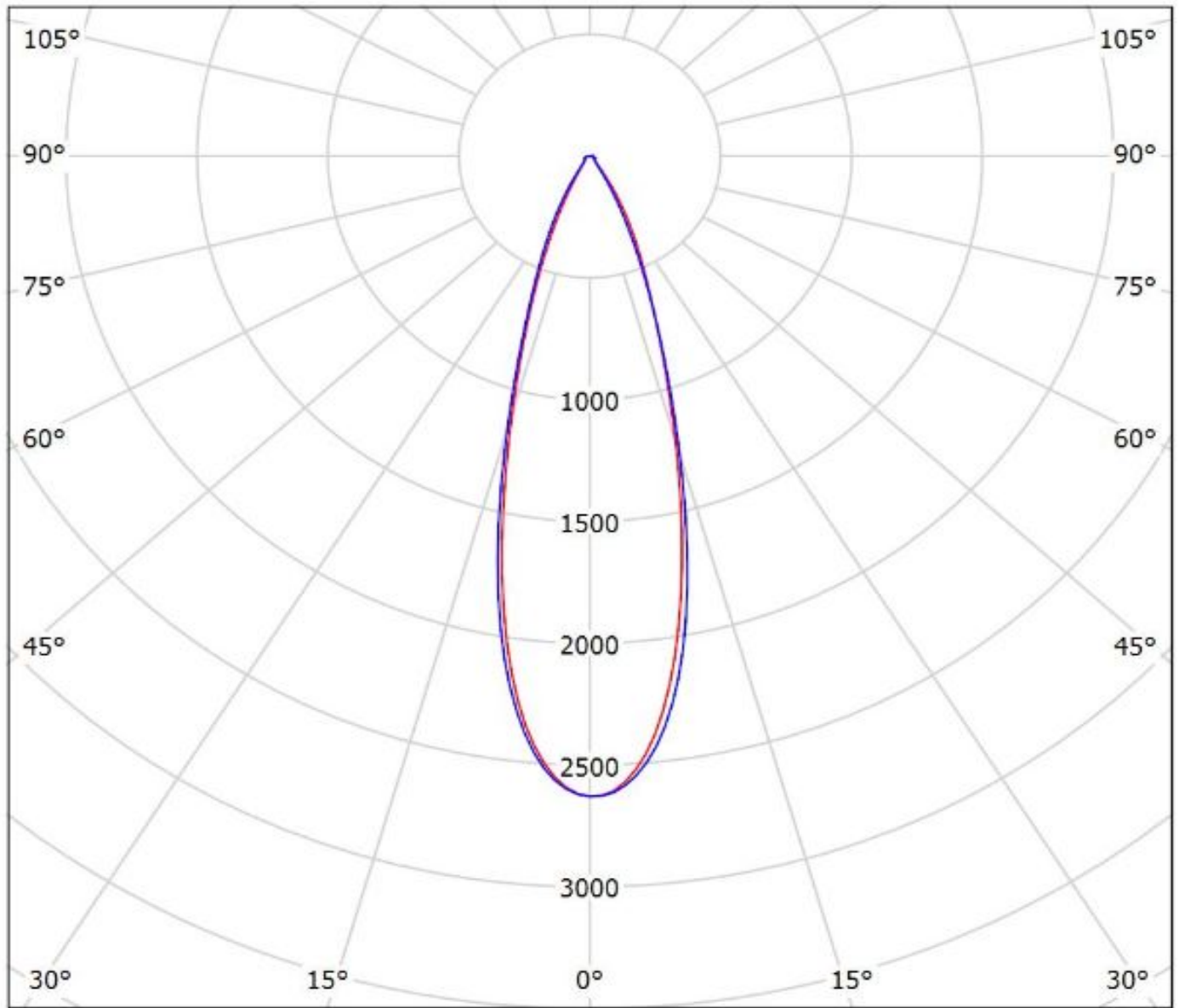

cd/klm

— C0 - C180

— C90 - C270

$\eta = 93\%$

Luminaire: Ledil CS14891_HB-IP-2X6-M_(Z8Y22_PLUS)

Lamps: 1 x Seoul_Z8Y22_PLUS_2X6_(SZ8-Y22-W0-C7P)1489.65lm@250mA_P=8.30675W_I=0.250A

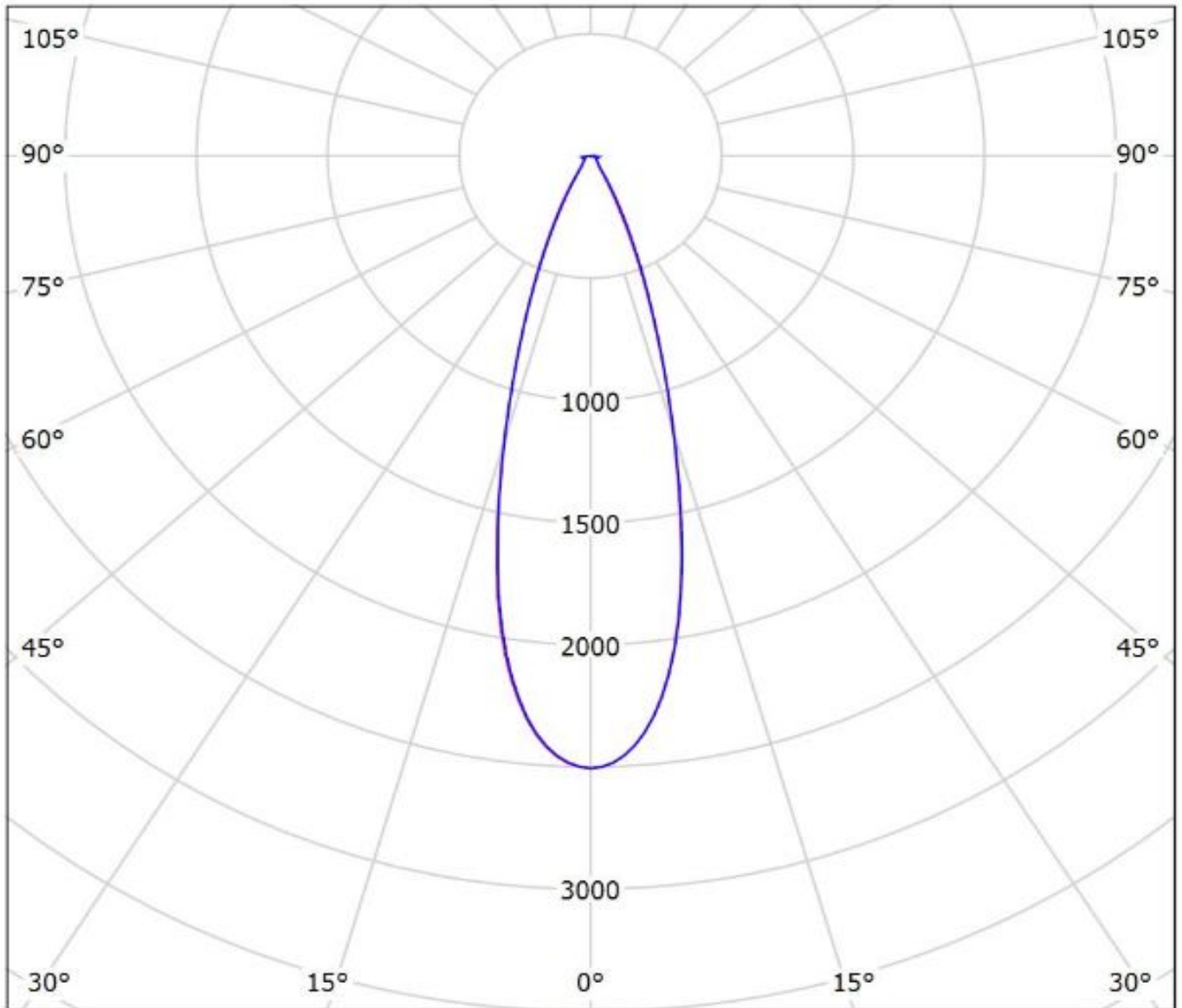

cd/klm

— C0 - C180

— C90 - C270

η = 93%

NOTE: The typical divergence will be changed by different color, chip size and chip position tolerance. The typical total divergence is the full angle measured where the luminous intensity is half of the peak value.