

Product Data Sheet

8315100162

VWCF080KJFMS

AF80-00162 24V P/2U

15.500

ebmpapst

engineering a better life



AF80-00162 24V P/2U 15.500

INDEX

- 1 General 3**
- 2 Mechanics 3**
 - 2.1 General 3
 - 2.2 Connections 3
- 3 Operating Data 5**
 - 3.1 Electrical Interface - Input 5
 - 3.2 Electrical Operating Data 6
 - 3.3 Electrical Interface - Output 7
 - 3.4 Electrical Features 8
 - 3.5 Aerodynamics 9
 - 3.6 Sound Data 10
- 4 Environment 10**
 - 4.1 General 10
 - 4.2 Climatic Requirements 11
 - 4.3 EMC 11
- 5 Safety 12**
 - 5.1 Electrical Safety 12
 - 5.2 Approval Tests 12
- 6 Reliability 12**
 - 6.1 General 12

1 General

| | | |
|-------------------------------------|------------------------|--|
| Fan type | Axial | |
| Rotating direction looking at rotor | Counterclockwise | |
| Airflow direction | Air outlet over struts | |
| Bearing system | Ball bearing | |
| Mounting position - shaft | Any | |

2 Mechanics**2.1 General**

| | | |
|---|---|--|
| Width | 80,0 mm | |
| Height | 80,0 mm | |
| Depth | 38,0 mm | |
| Mass | 0,220 kg | |
| Housing material | Plastic | |
| Impeller material | Plastic | |
| Max. torque when mounted across both mounting flanges | Wire outlet corner: 50 Ncm Remaining corners: 110 Ncm | |
| Screw size | ISO 4762 - M4 degreased, without an additional brace and without washer | |

2.2 Connections

| | | |
|-----------------------|-------------|--|
| Electrical connection | Wires | |
| Lead wire length | L = 310 mm | |
| Tolerance | + - 10,0 mm | |
| Wire size (AWG) | 22 | |
| Insulation diameter | 1,70 mm | |

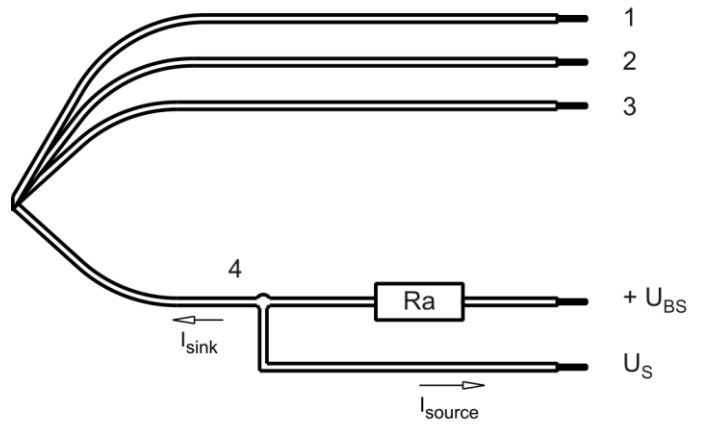

| Wire | Color | Operation | Wire size | Insulation diameter |
|------|--------|-----------|-----------|---------------------|
| 1 | red | + UB | AWG 22 | 1,70 mm |
| 2 | blue | - GND | AWG 22 | 1,70 mm |
| 3 | violet | PWM | AWG 22 | 1,70 mm |
| 4 | white | Tacho | AWG 22 | 1,70 mm |

The auxiliaries shown on the schematic diagram (which are required for the intended use) are not part of our delivery.

3 Operating Data

3.1 Electrical Interface - Input

| | |
|---------------|-----|
| Control input | PWM |
|---------------|-----|

Features

| | | |
|-----------------|----------------|---------------|
| Input type | Open collector | |
| PWM - Frequency | | 2 kHz - 5 kHz |

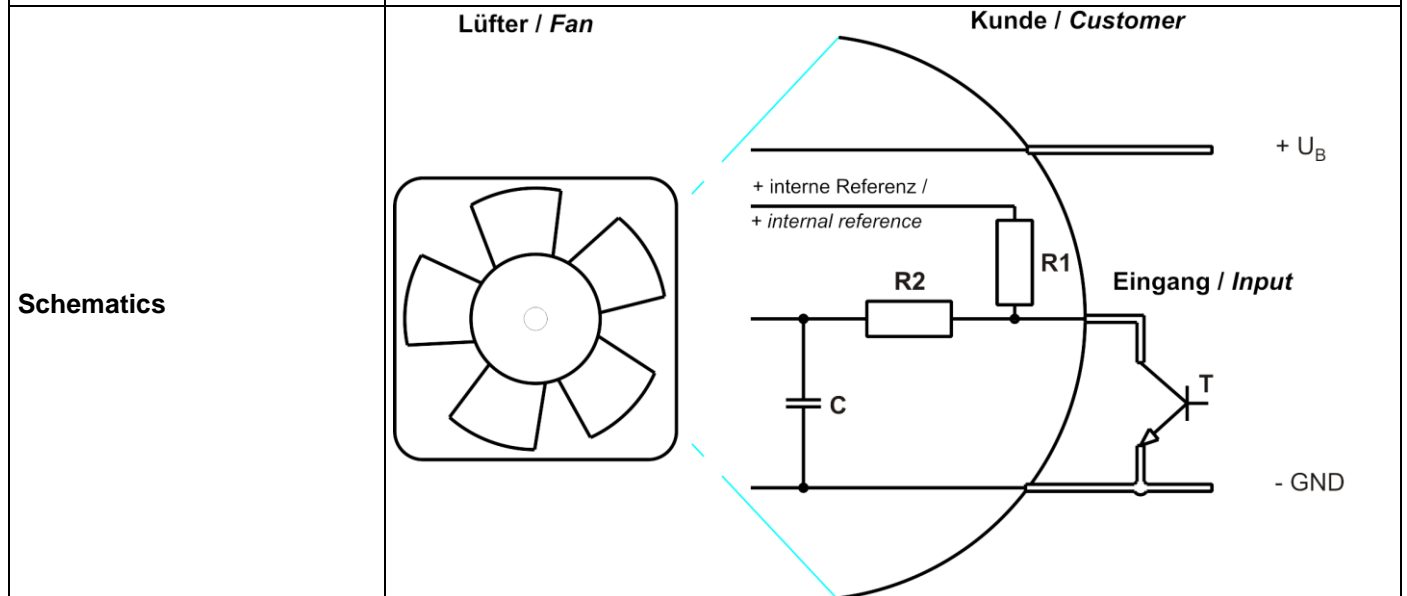
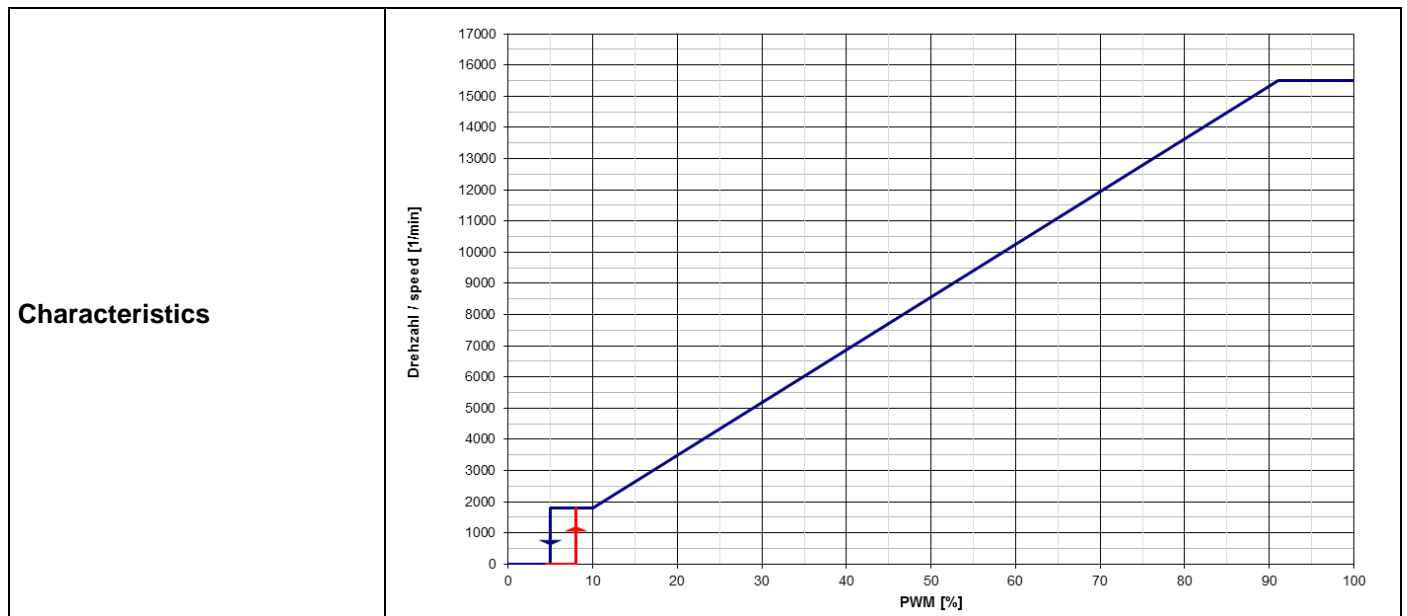

Speed controll: 0... 100 %, PWM-Low < 0,2 V

3.2 Electrical Operating Data

Measurement conditions: Normal air density = 1,2 kg/m³; Temperature 23°C +/- 3°C; Motor axis horizontal; warm-up time before measuring 5 minutes (unless otherwise specified). In the intake and outlet area should not be any solid obstruction within 0,5 m.

$\Delta p = 0$: corresp. to free air flow (see chapter aerodynamics)
I: corresp. to arithm. mean current value

| Name | Condition |
|----------|----------------------|
| PWM 0001 | PWM: 100 %; f: 2 kHz |

| Features | Condition | Symbol | Values | | |
|------------------------------|----------------|----------------|--------------|--------------|--------------|
| Voltage range | | U | 16 V | | 32 V |
| Nominal voltage | | U _N | | 24 V | |
| Power consumption | $\Delta p = 0$ | P | 25 W | 38 W | 38 W |
| Tolerance | PWM 0010 | | +/- 17,5 % | +/- 17,5 % | +/- 17,5 % |
| Current consumption | $\Delta p = 0$ | I | 1.550 mA | 1.600 mA | 1.200 mA |
| Tolerance | PWM 0010 | | +/- 17,5 % | +/- 17,5 % | +/- 17,5 % |
| Speed | $\Delta p = 0$ | n | 13.500 1/min | 15.500 1/min | 15.500 1/min |
| Tolerance | PWM 0010 | | +/- 12,5 % | +/- 7,5 % | +/- 5 % |
| Starting current consumption | | | | 4.000 mA | |

3.3 Electrical Interface - Output

| | |
|------------|---------------------|
| Tacho type | /2 (open collector) |
|------------|---------------------|

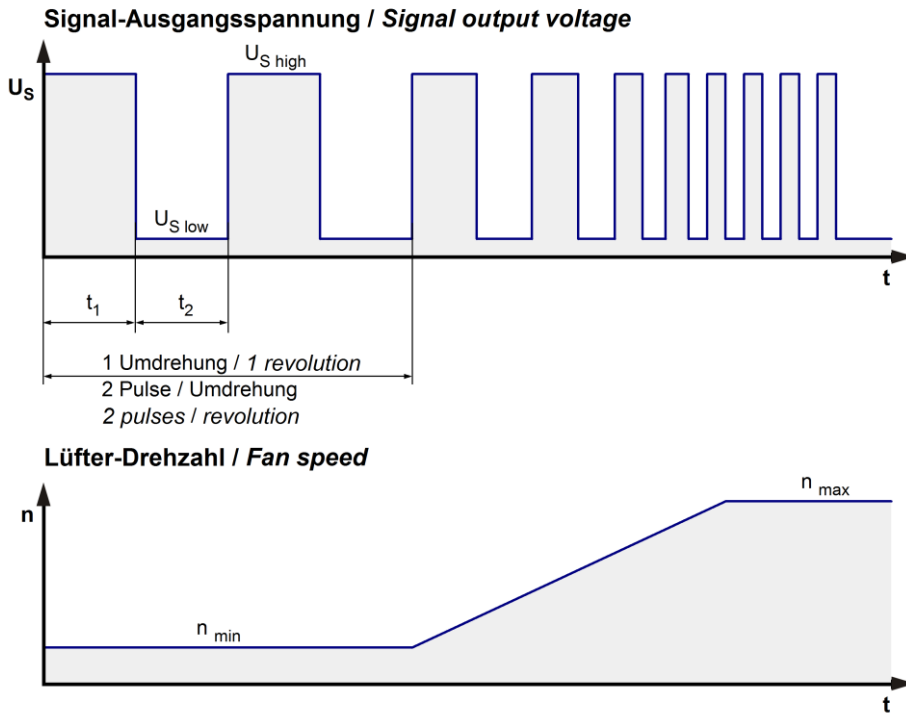

$$R_a = \frac{U_{BS} - U_{S\ low}}{I_{sink}}$$

Lüfter / Fan Kunde / Customer

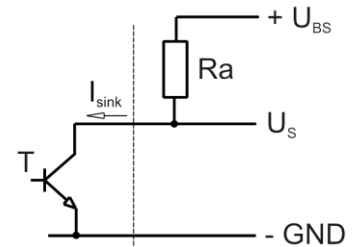

| Features | Note | Values |
|---------------------------|--|---|
| Tacho operating voltage | U_{BS} | $\leq 32\text{ V}$ |
| Tacho signal Low | $U_{S\ low}$ | $I_{sink}: 2\text{ mA}$ $\leq 0,4\text{ V}$ |
| Tacho signal High | $U_{S\ high}$ | $I_{source}: 0\text{ mA}$ $\leq 32\text{ V}$ |
| Maximum sink current | I_{sink} | $\leq 4\text{ mA}$ |
| External resistor | External resistor R_a from U_{BS} to U_S required. All voltages measured to GND. | |
| Tacho frequency | $(2 \times n) / 60$ | |
| Tacho isolated from motor | No | |
| Slew rate | | $\Rightarrow 0,5\text{ V/us}$ |

n = revolutions per minute (1/min)

3.4 Electrical Features

| | | |
|--------------------------------|-------------------------------------|--|
| Electronic function | Speed-Controlled | |
| Reversed polarity protection | P-CH FET | |
| Max. residual current at U_N | $I_F \leq 150 \mu A$ | |
| Locked rotor protection | Auto restart | |
| Locked rotor current at U_N | I_{block} approx. 150 mA | |
| Clock signal at locked rotor | t_3 / t_4 typical: 2,7 s / 10,0 s | |

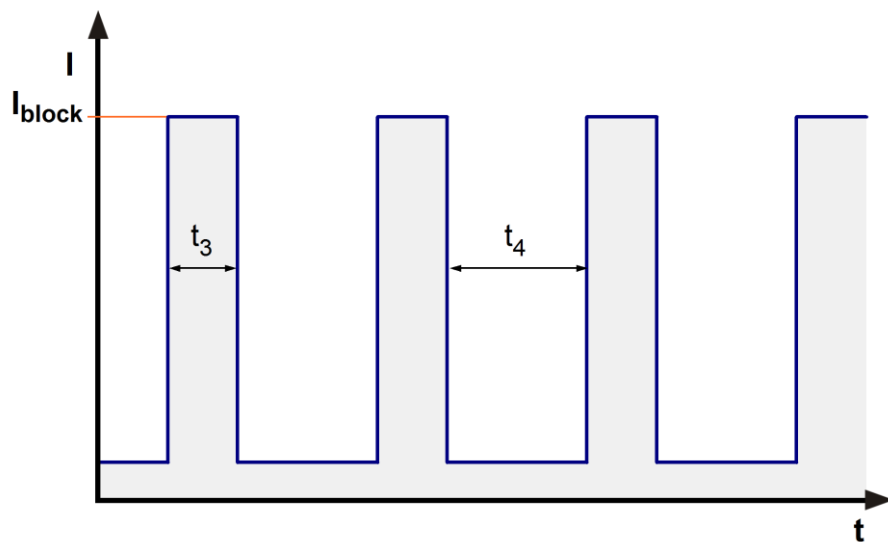

3.5 Aerodynamics

Measurement conditions: Measured with a double chamber intake rig acc. to DIN EN ISO 5801. Normal air density = 1,2 kg/m³; Temperature 23°C +/- 3°C; In the intake and outlet area should not be any solid obstruction within 0,5 m. Motor shaft horizontal. The information is only valid under the specified test conditions and may be changed by the installation conditions. If there are deviations from the standard test conditions, the characteristic values must be checked under the installed conditions.

a.) Operation condition:

| | | | |
|-------------------------------|---------------------|--|--|
| 15.500 1/min at free air flow | PWM 100 %; f: 2 kHz | | |
|-------------------------------|---------------------|--|--|

| | | |
|---|-----------------------|--|
| Max. free-air flow ($\Delta p = 0 / \dot{V} = \text{max.}$) | 204 m ³ /h | |
| Max. static pressure ($\Delta p = \text{max.} / \dot{V} = 0$) | 1.120 Pa | |

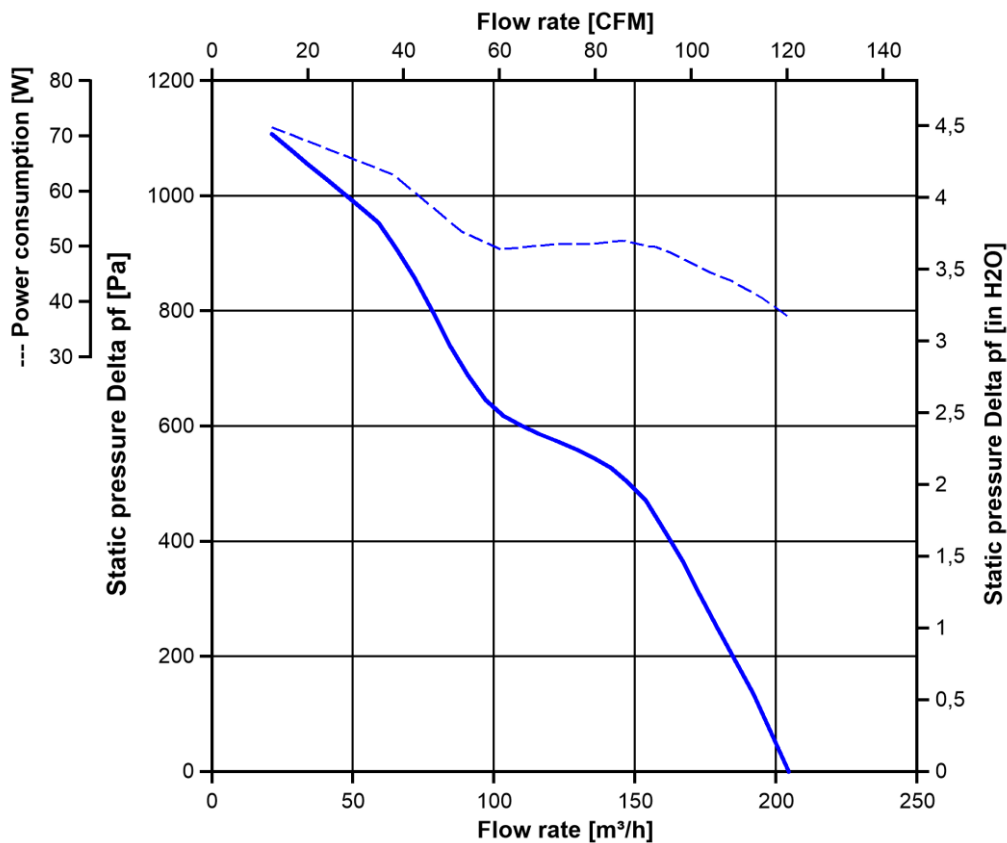

3.6 Sound Data

Measurement conditions: Sound pressure level: 1 meter distance between microphone and the air intake.
Sound power level: According to ISO 13347-3.
Measured in a semianechoic chamber with a background noise level of $L_p(A) < 5 \text{ dB}(A)$
For further measurement conditions see chapter aerodynamics.

a.) Operation condition:

| | | | |
|-------------------------------|---------------------|--|--|
| 15.500 1/min at free air flow | PWM 100 %; f: 2 kHz | | |
|-------------------------------|---------------------|--|--|

| | | | |
|---|--------------------------------|--|--|
| Optimal operating point | 145 m ³ /h @ 530 Pa | | |
| Sound power level at the optimal operating point | 8,2 bel(A) | | |
| Sound pressure level at free air flow, measured in rubber bands | 71 dB(A) | | |

4 Environment

4.1 General

| | | | |
|--|--------|--|--|
| Min. permitted ambient temperature TU min. | -20 °C | | |
| Max. permitted ambient temperature TU max. | 65 °C | | |
| Min. permitted storage temperature TL min. | -40 °C | | |
| Max. permitted storage temperature TL max. | 80 °C | | |

4.2 Climatic Requirements

| | | |
|--------------------------------|---|--|
| IP-protection type (certified) | IP 68 (for fan only, not for connector if applicable) **) | |
| Humidity requirements | humid temperature, cyclic; according to DIN EN 60068-2-38, 10 cycle and condensation water check; according to DIN EN ISO 6270-2, 14 days | |
| Salt fog requirements | salt fog, cyclic, in operation; according to DIN EN 60068-2-52, 3 cycle | |

Permitted application area:

The product is for the use in open and unsheltered areas. Direct exposure to water as well as saline ambient conditions are allowed provided that this does not prevent the normal operation.

Pollution degree 3 (according DIN EN 60664-1)

It occurs conductive pollution or dry non-conductive pollution which becomes conductive due to condensation.

***) The specification of the IP protection refers to the conditions mentioned in certification of the fan. The above mentioned short description of the protection scope is not final. For detailed information of the respective protection scope and definitions, see certification as well as DIN EN 60529 (protection by housings) and ISO 20653 (for vehicles) with the letter K.

Short description of the IP-protection type:

Solid particle Protection: Dust tight.

Protection against deliberate contact: Protected against contact to hazardous parts with a wire.

Protection against water: The fan test according to IP68 (Based on IEC 60529), is conducted in non-operating mode. The fan is tested by a complete immersion in water for a period of 2h at a water-level of 1,2m. Electrical connections are not immersed since they are customer specific.

Please require severity levels and specification parameters from the responsible development departments.

4.3 EMC

| Kind | Radiated Emission; 30 MHz - 1000 MHz |
|------------------------|--------------------------------------|
| According | DIN EN 55032:2016-02 |
| Check accuracy / Limit | Class B |
| Result | Below limit Class B |

| Kind | Electrostatic Discharge Immunity Test |
|------------------------|--|
| According | DIN EN 61000-4-2:2001-12 |
| Check accuracy / Limit | Contact Discharge +/- 4 kV; Air Discharge +/- 8 kV |
| Result | A: The monitored function operates as designed during and after exposure to a disturbance. |

5 Safety

5.1 Electrical Safety

| | | |
|---|--|--|
| Dielectric strength DIN EN 62368 and DIN EN 60335 A.) Type test Measuring conditions: After 48h of storage at 95% R.H. and 25°C. No arcing or breakdown is allowed! All connections together to ground. B.) Routine test Measuring conditions: At indoor climate. No arcing or breakdown is allowed! All connections together to ground. | 500 VAC / 1 Min. 850 VDC / 1 Sec. | |
| Isolation resistance Measuring conditions: After 48h of storage at 95% R.H. and 25°C measured with U=500 VDC for 1 min. | RI > 10 MOhm | |
| Clearance / creepage distance | 1,0 mm / 1,2 mm | |
| Protection class | III | |

5.2 Approval Tests

| | | |
|-----|---|---|
| CE | EC Declaration of Conformity | Yes |
| EAC | Eurasian Conformity | Yes |
| UL | Underwriters Laboratories | Yes / UL507, Electric Fans E38324 |
| VDE | Association for Electrical, Electronic and Information Technologies | Yes / Approval acc. to EN 62368 - Audio/video, information and communication technology equipment |
| CSA | Canadian Standards Association | Yes / CSA audited by UL according to C22.2 No. 113 Fans and Ventilators |
| CCC | China Compulsory Certification | Not applicable |

6 Reliability

6.1 General

| | | |
|--|----------|--|
| Life expectancy L10 at TU = 40 °C | 40.000 h | |
| Life expectancy L10 at TU max. | 22.500 h | |
| Life expectancy L10 acc. to IPC 9591 at TU = 40 °C | 67.500 h | |

The reproduction, distribution and utilization of this document as well as the communication of its contents to others without express authorization is prohibited. Offenders will be held liable for the payment of damages. All rights reserved in the event of the grant of a patent, utility model or design. Refer to protection notice ISO 18016.

AxiForce 80 Baureihe
AxiForce 80 series

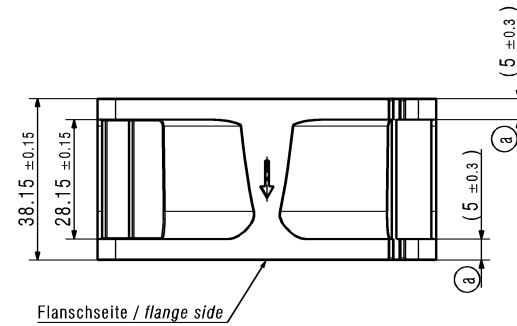
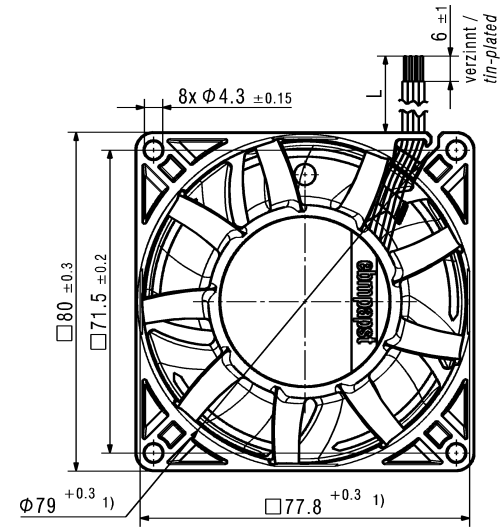
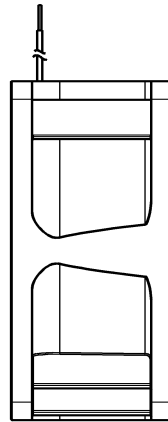
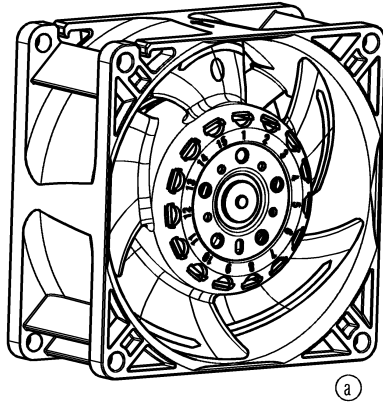

- 1) Maße für Montagewand / Dimensions for assembly wall
- Kein Axialspiel der Kugellager durch Federausgleich/
No axial clearance of ball bearings due to a pre-load spring
 - Anzahl und Länge der Litze siehe Produktspezifikation
Quantity and length of the wires according to design specification

| | | | | | | | |
|---|--|---------------|----------|---------------|------------|--------------------|--|
| Title | | | | Material | | Digital signature | |
| First created for | | Index A | Doc type | Sheet | Change-No. | | |
| Designed name | | Designed date | | Volume (mm³) | | CAD environment | |
| Substitute for | | Released name | | Released date | | Mass (g) | |
| <p align="center">ebmpapst</p> <p align="center">ebm-papst St. Georgen GmbH & Co. KG</p> | | | | Tolerances | | General tolerances | |
| | | | | Scale | | Format | |
| Document status | | | | | | | |