

Bulk Metal® Foil Technology Ultra High Precision Trimming Potentiometers, QPL Approved 1/4" Square, Qualified to MIL-PRF-22097, Char. F, RJ26 with a Smooth and Unidirectional Output

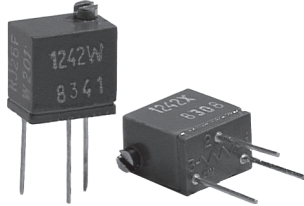

INTRODUCTION

Vishay Foil precision trimmers have the Bulk Metal® Foil resistive element which possesses a unique inherent temperature and load life stability. Plus, their advanced virtually back lash-free adjustment mechanism makes them easy to set quickly and accurately and keeps the setting exactly on target.

FEATURES

- Temperature coefficient of resistance (TCR): ± 10 ppm/°C maximum ⁽⁴⁾ (- 55 °C to + 150 °C ref. at + 25 °C); through the wiper ⁽⁵⁾; ± 25 ppm/°C
- A smooth and unidirectional resistance with leadscrew adjustment
- Load life stability: 0.1 % typical ΔR , 1.0 % maximum ΔR under full rated power of 0.25 W at 85 °C for 1000 h
- Settability: 0.05 % typical; 0.1 % maximum
- Setting stability: 0.1 % typical; 0.5 % maximum, ΔSS
- Power rating: 0.25 W at + 85 °C
- Resistance range: 20 Ω to 5 k Ω
- Resistance tolerance: ± 10 %
- Electrostatic discharge (ESD) up to 25 000 V
- Terminal finish: gold plated (tin/lead finish is available on request)

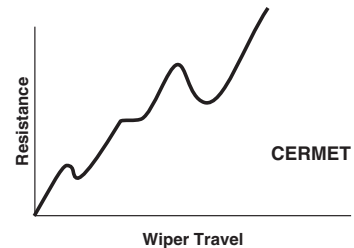
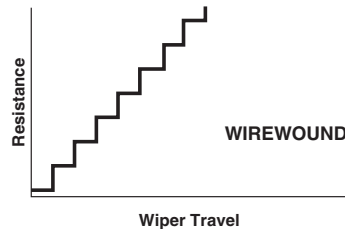
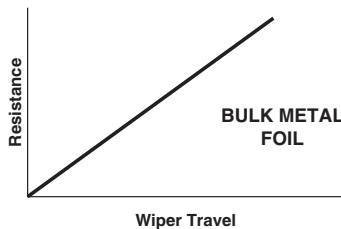

TABLE 1 - MODEL SELECTION

MODEL	TERMINATION STYLE	AVERAGE WEIGHT (g)	STANDARD RESISTANCE VALUES (in Ω) ⁽¹⁾	STANDARD TOLERANCE ⁽²⁾	POWER RATING at + 85 °C AMBIENT	NO. OF TURNS
1242 (RJ26)	W-edge mount, top adjust	0.4	20, 50, 100, 200, 500, 1K, 2K, 5K	± 10 %	0.25 W	21 \pm 2
	X-edge mount, side adjust					

Note

- See figure 1

TABLE 2 - 1242 (RJ26) SERIES ELECTRICAL SPECIFICATIONS ⁽³⁾

Temperature Coefficient of Resistance (TCR), 50 Ω to 10 k Ω End-to-end ⁽⁴⁾	± 10 ppm/°C maximum (- 55 °C to + 150 °C, 25 °C ref.)
Temperature Coefficient of Resistance (TCR), 5 Ω , 10 Ω and 20 Ω End-to-end ⁽⁴⁾	± 20 ppm/°C
Through the wiper ⁽⁵⁾	± 25 ppm/°C
Stability Load life at 1000 h	0.1 % typical ΔR 1.0 % maximum ΔR (under full rated power of 0.25 W at + 85 °C)
Power Rating (at + 85 °C) ⁽⁶⁾	0.25 W
Settability	0.05 % typical; 0.1 % maximum
Setting Stability	0.1 % typical; 0.5 % maximum ΔSS
Contact Resistance Variation - CRV (noise)	± 3 % or 3 Ω ⁽⁷⁾
Hop-off	0.25 % typical; 1.0 % maximum
High-Frequency Operation Rise time Inductance Capacitance	1.0 ns without ringing 0.08 μH typical 0.5 pF typical
Operating Temperature Range	- 55 °C to + 150 °C

Note

- See page 3 for footnotes

TABLE 3 - MECHANICAL SPECIFICATIONS

Adjustment Turns	21 ± 2
Mechanical Stops	Wiper idles - no discontinuity
Internal Terminations	All welded - no flux
Case Material	Diallyl-phthalate: green (DAP)
Shaft Torque	3 oz. in. maximum
Backlash	0.005 % typical

FIGURE 1 - SCHEMATIC AND DIMENSIONS in Inches (Millimeters)

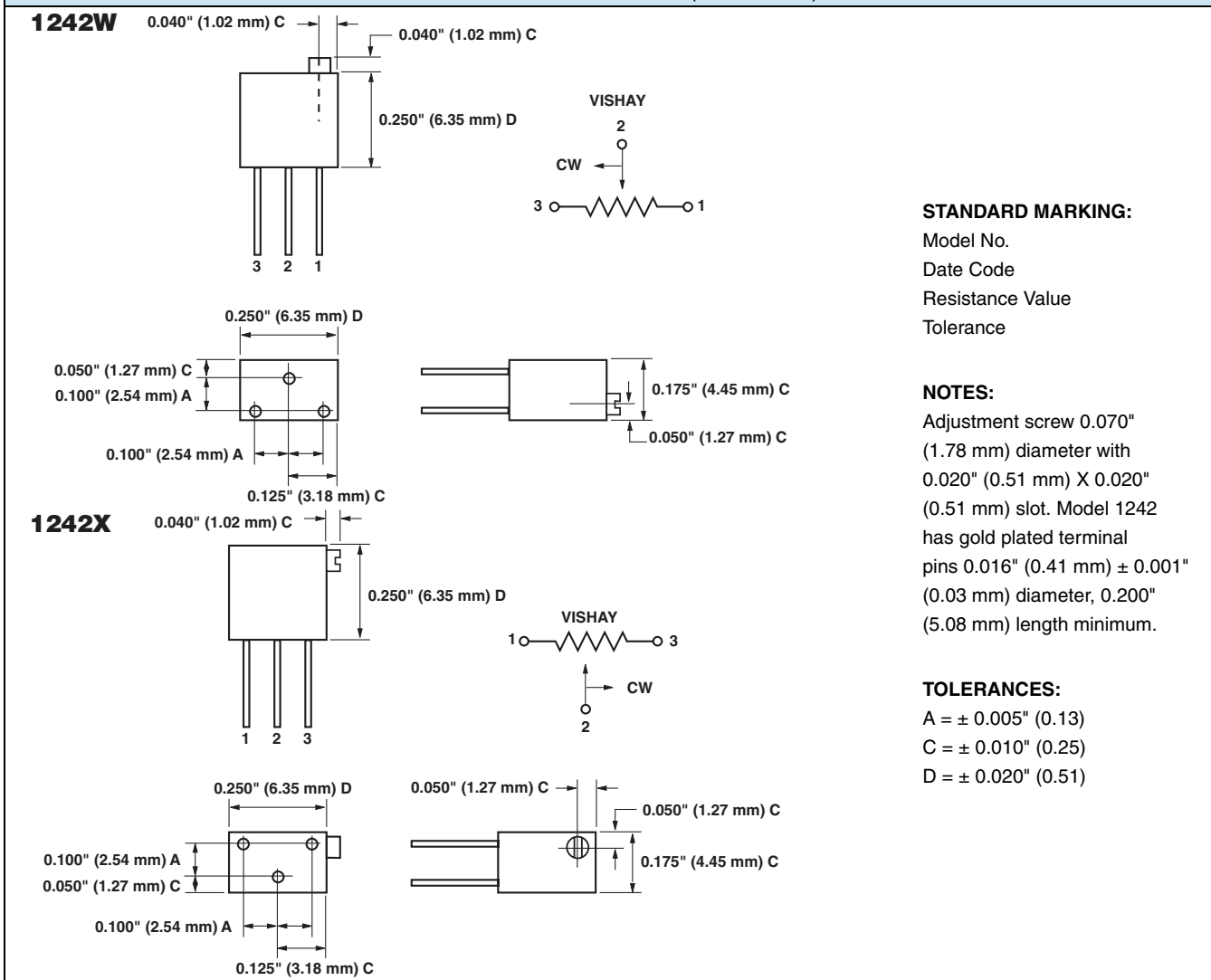

FIGURE 2 - POWER DERATING CURVE

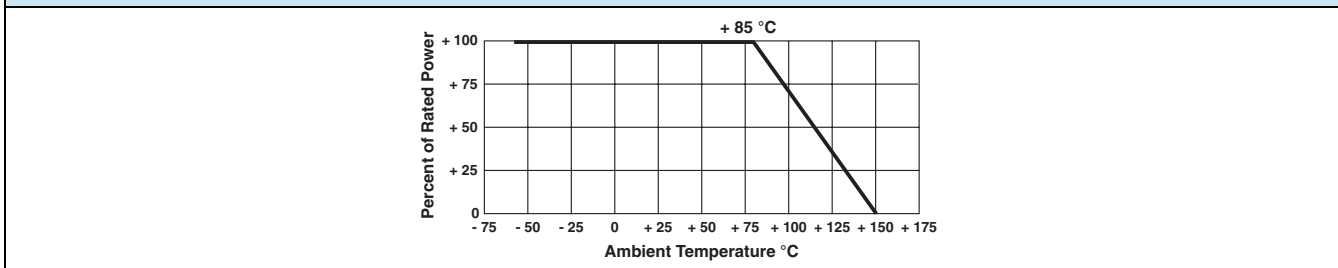

TABLE 4 - COMPARISON

	MIL-PRF-22097/5 CHARACTERISTIC F ⁽⁸⁾	(RJ26) 1242 SPECIFICATIONS
TEST GROUP I		
Visual and mechanical	No failures	No failures
Total resistance	± 10 %	± 10 %
Actual effective electrical travel	10 to 25 turns	21 ± 2 turns
End resistance	± 2 % or 20 Ω ⁽⁷⁾	2 Ω (values ≤ 1 kΩ) ; 5 Ω (values ≥ 2 kΩ)
Contact resistance variation - CRV (noise)	± 3.0 % or 3 Ω ⁽⁷⁾	± 3.0 % or 3 Ω ⁽⁷⁾
Dielectric withstanding voltage - DWV Per MIL-STD-202, methods 301 and 105		
Atmospheric pressure	600 V _{AC} , 1 min	600 V _{AC} , 1 min
Barometric pressure	250 V _{AC} , 1 min	250 V _{AC} , 1 min
Insulation resistance	> 1000 MΩ	> 1000 MΩ
Shaft torque	3 oz. in. maximum	3 oz. in. maximum
Thermal shock	± 1.0 %	0.1 % typical; 0.5 % maximum
TEST GROUP II		
Resistance temperature characteristic - TCR	± 0.01 %/°C (± 100 ppm/°C)	± 0.001 %/°C (± 10 ppm/°C)
Moisture resistance	± 1.0 %	± 0.5 %
Contact resistance variation - CRV (noise)	± 3.0 % or 3 Ω ⁽⁷⁾	± 3.0 % or 3 Ω ⁽⁷⁾
TEST GROUP III		
Shock (specified pulse)	± 1.0 %	± 0.5 %
Vibration (high-frequency)	± 1.0 %	± 0.5 %
Contact resistance variation - CRV (noise)	± 3.0 % or 3 Ω ⁽⁷⁾	± 3.0 % or 3 Ω ⁽⁷⁾
Salt spray	No corrosion	No corrosion
TEST GROUP IV		
Solder heat	± 1.0 %	± 0.1 %
Life (1000 h at 85 °C)	± 2.0 %	± 1.0 %
Contact resistance variation - CRV (noise)	± 3.0 % or 3 Ω ⁽⁷⁾	± 3.0 % or 3 Ω ⁽⁷⁾
TEST GROUP V		
Low-temperature operation	± 1.0 %	± 0.5 %
High-temperature exposure	± 2.0 %	± 0.5 %
Contact resistance variation - CRV (noise)	± 3.0 % or 3 Ω ⁽⁷⁾	± 3.0 % or 3 Ω ⁽⁷⁾
TEST GROUP VI		
Rotational life	± 2.0 %	± 2.0 %
Contact resistance variation - CRV (noise)	± 3.0 % or 3 Ω ⁽⁷⁾	± 3.0 % or 3 Ω ⁽⁷⁾
Terminal strength	2 lbs.	2 lbs.
TEST GROUP VII		
Solderability	MIL-STD-202 method 208	MIL-STD-202 method 208
Immersion	No continuous stream of bubbles	No continuous stream of bubbles
TEST GROUP VIII		
Fungus	MIL-STD-810 method 508 No mechanical damage	MIL-STD-810 method 508 No mechanical damage

Notes

- (1) 5 Ω and 10 Ω resistance values available on special order.
- (2) 5 % resistance tolerance available on special order.
- (3) Maximum is 1.0 % A.Q.L. standard for all specifications except TCR. (For TCR information, see notes 4 and 5.) "Typical" is a designers reference which represents that 85 % of the lots supplied, over a long period of time, will be at least the figure shown or better.
- (4) Maximum TCR applies to the 3 σ (sigma) limit or 99.73 % of a production lot. (Measured end-to-end with wiper off the element.)
- (5) Measurements of TCR through the wiper are influenced more by setting stability and the percentage of the total/resistance in use (at the wiper) than by fundamental resistance change due to temperature alone. The parameter shown in table 2 is a 2 s distribution typifying the behavior of the device when used with 40 % or more of the total resistance in use.
- (6) Derated linearly from full power at + 85 °C to zero power at + 150 °C. See figure 2 on previous page.
- (7) Whichever is greater.
- (8) All ΔR's are measured to the tolerance specified + 0.01 Ω.

TABLE 5 - GLOBAL PART NUMBER INFORMATION

NEW GLOBAL PART NUMBER: Y0057500R000K0L (preferred part number format)

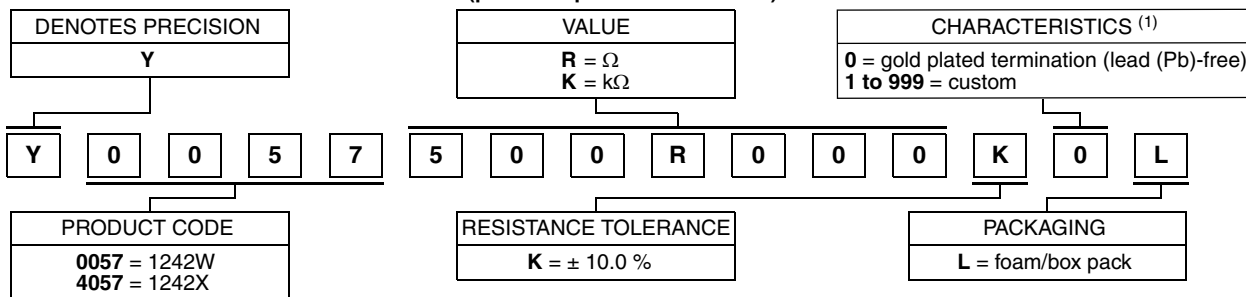

FOR EXAMPLE: ABOVE GLOBAL ORDER Y0057 500R000 K 0 L:

TYPE: 1242W

VALUE: 500.0 Ω

ABSOLUTE TOLERANCE: ± 10.0 %

TERMINATION: gold plated (lead (Pb)-free)

PACKAGING: foam/box pack

HISTORICAL PART NUMBER: RJ26 F W 501 (will continue to be used)

RJ26	F	W	501
MODEL	CHARACTERISTIC	MOUNTING TYPE	RESISTANCE VALUE
RJ26	Having specifications per table 1 of MIL-PRF-22097 (i.e., TCR of 100 ppm/°C, power rating of 0.25 W at + 85 °C and improved environmental specifications)	W, PC pins (edge mount, top adjust) X, PC pins (edge mount, side adjust)	First 2 digits significant, last digit represents the number of zeros (i.e., 501 = 500 Ω)

Note

(1) For non-standard requests, please contact application engineering.

Disclaimer

ALL PRODUCTS, PRODUCT SPECIFICATIONS AND DATA ARE SUBJECT TO CHANGE WITHOUT NOTICE.

Vishay Precision Group, Inc., its affiliates, agents, and employees, and all persons acting on its or their behalf (collectively, "VPG"), disclaim any and all liability for any errors, inaccuracies or incompleteness contained herein or in any other disclosure relating to any product.

The product specifications do not expand or otherwise modify VPG's terms and conditions of purchase, including but not limited to, the warranty expressed therein.

VPG makes no warranty, representation or guarantee other than as set forth in the terms and conditions of purchase. **To the maximum extent permitted by applicable law, VPG disclaims (i) any and all liability arising out of the application or use of any product, (ii) any and all liability, including without limitation special, consequential or incidental damages, and (iii) any and all implied warranties, including warranties of fitness for particular purpose, non-infringement and merchantability.**

Information provided in datasheets and/or specifications may vary from actual results in different applications and performance may vary over time. Statements regarding the suitability of products for certain types of applications are based on VPG's knowledge of typical requirements that are often placed on VPG products. It is the customer's responsibility to validate that a particular product with the properties described in the product specification is suitable for use in a particular application. You should ensure you have the current version of the relevant information by contacting VPG prior to performing installation or use of the product, such as on our website at vpgsensors.com.

No license, express, implied, or otherwise, to any intellectual property rights is granted by this document, or by any conduct of VPG.

The products shown herein are not designed for use in life-saving or life-sustaining applications unless otherwise expressly indicated. Customers using or selling VPG products not expressly indicated for use in such applications do so entirely at their own risk and agree to fully indemnify VPG for any damages arising or resulting from such use or sale. Please contact authorized VPG personnel to obtain written terms and conditions regarding products designed for such applications.

Product names and markings noted herein may be trademarks of their respective owners.

Copyright Vishay Precision Group, Inc., 2014. All rights reserved.