

Data Sheet iSYS-5020

Version 1.5 - 08.05.18



PRODUCT FAMILY

3D-MIMO-RADAR

APPLICATIONS

- Area Surveillance

- Movement
- Velocity
- Direction
- Presence
- Distance
- Angle

FEATURES

- » MIMO-Radar working in the 24GHz - ISM - Band
- » Simultaneous capture of speed, distance and angular deviation of a target
- » Detection of targets up to 150m in distance
- » Unambiguous velocity: 35.3 km/h
- » FOV $\pm 75^\circ$ with an angular resolution of $< 12^\circ$ in azimuth
- » Target list on SPI and Ethernet
- » UART command interface
- » Compact design 101 x 79 x 12.4mm

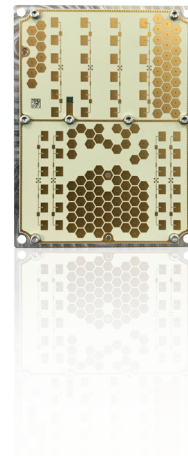

DESCRIPTION

Detection and separation of moving and stationary targets according to their speed, range and azimuth angle allows the possibility to detect a target in a 2-dimensional environment.

High speed modulation concept for best signal to noise performance.

Simultaneous capture of speed, distance and angular deviation of a target.

Complete signal processing included. Communication interface on UART. Target list output on SPI or Ethernet.

ADDITIONAL INFORMATION

InnoSenT Standard Product. Changes will not be notified as long as there is no influence on form, fit and within this data sheet specified function of the product.

CERTIFICATES

InnoSenT GmbH has established and applies a quality system for: development, production and sales of radar sensors for industrial and automotive sensors.



RoHS-INFO

This product is compliant to the restriction of hazardous substances (RoHS - European Union directive 2011/65/EU).

CONFIDENTIAL AND PROPRIETARY

The information contained in this document shall remain the sole and exclusive property of InnoSenT GmbH and shall not be disclosed by the recipient to third parties without prior consent of InnoSenT in writing.

PARAMETERS

The iSYS-5020 consist of a 24GHz Radar Front End (RFE) with a DSP-Board for measure of distance, radial velocity and angle of arrival of targets. The output of the sensor is a target list.

PARAMETER	CONDITIONS	SYMBOL	MIN	TYP	MAX	UNITS
Radar						
transmit frequencies		$f_{iSYS-5020}$	24.050		24.250	GHz
output power	according to ETSI 300 440	P_{out_ETSI}			20	dBm
field strength at 3 meters along the antenna azimuth	according to FCC 15.249	P_{out_FCC}			250	mV/m
Sensor						
typical detection range	person	d_r	1		120	m
	car				150	m
distance error		d_{error}		±1.5		m
distance resolution		d_{res}		1.26		m
velocity range		v_r	-34.3		+34.3	km/h
velocity error		v_{error}			±0.55	km/h
velocity resolution		v_{res}		0.55		km/h
antenna pattern (10dB width)	compare with plot on page 3	azimuth		150		°
		elevation		26		°
angle detection				±75		°
angle error	within ±55° FOV			±1		°
angle resolution				8	12	°
update time				100		ms
Power supply						
supply voltage		V_{CC}	6.1	6.25	6.4	V
ripple		V_{ripple}			5	mV
supply current		I_{CC}			1000	mA
Environment						
operating temperature	with Ethernet and SPI interface ¹	T_{OP}	-40		+70	°C
storage temperature		T_{STG}	-40		+85	°C
¹ Extended temperature -40°C - +85°C with SPI only on request						
Mechanical Outlines						
outline dimensions	compare to schematic on page 5	height length width		16.5 100.75 78.5		mm

CONFIDENTIAL AND PROPRIETARY

The information contained in this document shall remain the sole and exclusive property of InnoSenT GmbH and shall not be disclosed by the recipient to third parties without prior consent of InnoSenT in writing.

TRANSIENT CURRENT

The Analog Front End (AFE) operates in a duty cycle mode to save energy and to avoid a strong heating of the iSYS-5020 RADAR-Sensor.

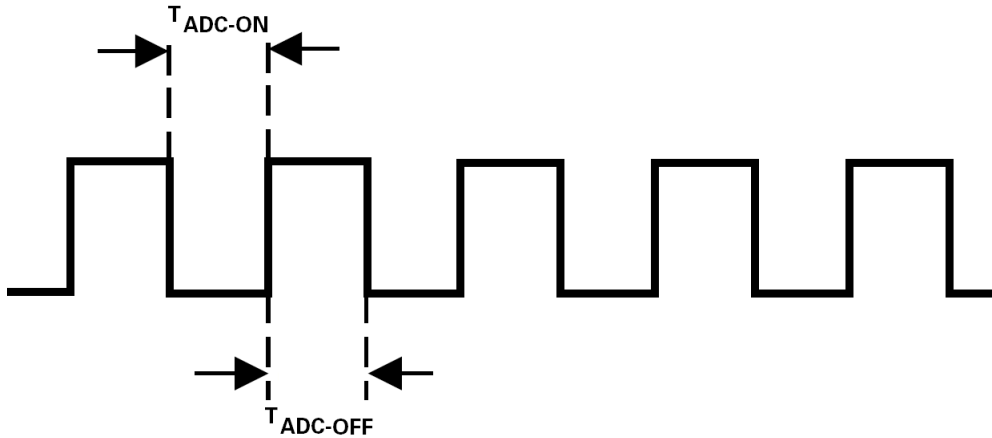

$$T_{ADC-ON} = 43.15\text{ms}$$

$$T_{ADC-OFF} = 56.85\text{ms}$$

$$I_{ADC-ON} = \text{typ. } 820\text{mA (@6.25V)}$$

$$I_{ADC-OFF} = \text{typ. } 640\text{mA (@6.25V)}$$

$$I_{\text{supply}} = \text{typ. } 720\text{mA (@6.25V)}$$

CONFIDENTIAL AND PROPRIETARY

The information contained in this document shall remain the sole and exclusive property of InnoSenT GmbH and shall not be disclosed by the recipient to third parties without prior consent of InnoSenT in writing.

ANTENNA PATTERN

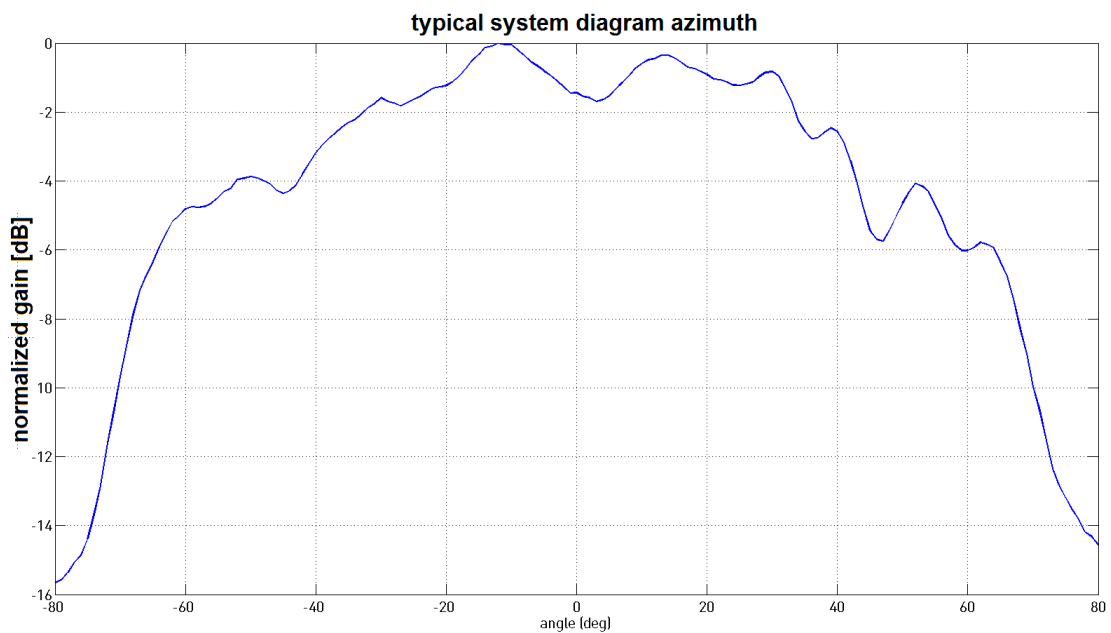
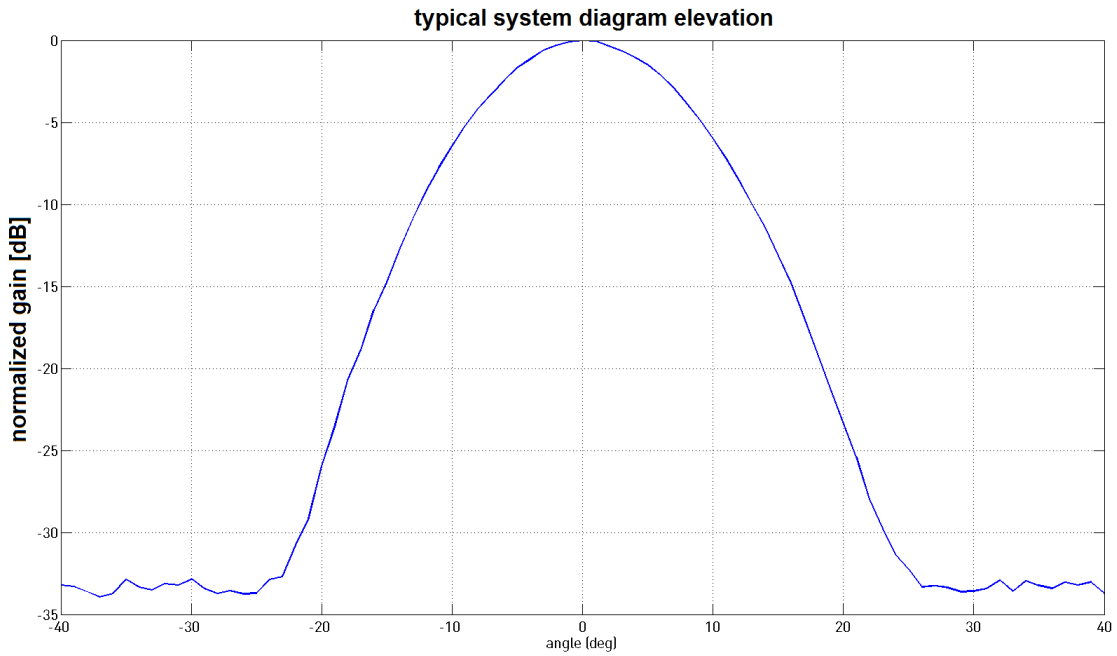

CONFIDENTIAL AND PROPRIETARY

The information contained in this document shall remain the sole and exclusive property of InnoSenT GmbH and shall not be disclosed by the recipient to third parties without prior consent of InnoSenT in writing.

INTERFACE

The iSYS-5020 provides a 14 Pin 2.54 mm pitch female header. This connector (W+P 3492-14-3- 00-00) is a dual entry type and is mounted on the inner side of the DSP-board. InnoSenT uses a gold-plated connector. The length of the mating connector should be 5.32mm ± 0.5mm (e.g. W+P3132-12-14-00-0-ST).

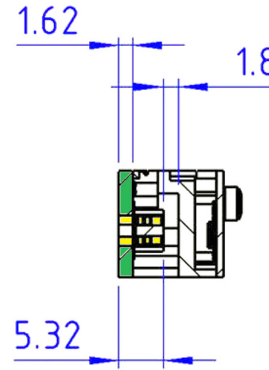
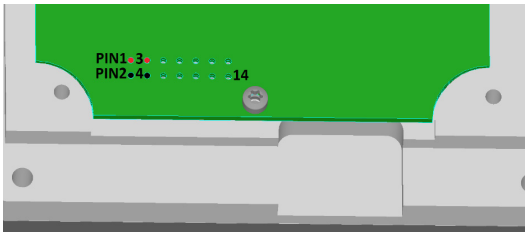

PIN #	DESCRIPTION	COMMENT
1	6.25V_IN •	Power Supply, 1000mA max.
2	GND •	
3	6.25V_IN •	
4	GND •	
5	SPI_CLK	SPI -> default interface for target list output, CLK 5 MHz max.
6	ETH_EXT.TPIA_P	Ethernet -> secondary interface for target list output, 100 Mbit/s
7	SPI_CS	SPI -> default interface for target list output
8	ETH_EXT.TPIA_N	Ethernet -> secondary interface for target list output
9	SPI_MOSI	SPI -> default interface for target list output
10	ETH_EXT.TPIB_P	Ethernet -> secondary interface for target list output,
11	SPI_MISO	SPI -> default interface for target list output
12	ETH_EXT.TPIB_N	Ethernet -> secondary interface for target list output, 100 Mbit/s
13	UART_RX	UART -> command interface for configuration (3.3 V)
14	UART_TX	

CONFIDENTIAL AND PROPRIETARY

The information contained in this document shall remain the sole and exclusive property of InnoSenT GmbH and shall not be disclosed by the recipient to third parties without prior consent of InnoSenT in writing.

MECHANICAL DRAWING

top view

The module must be installed with this side up

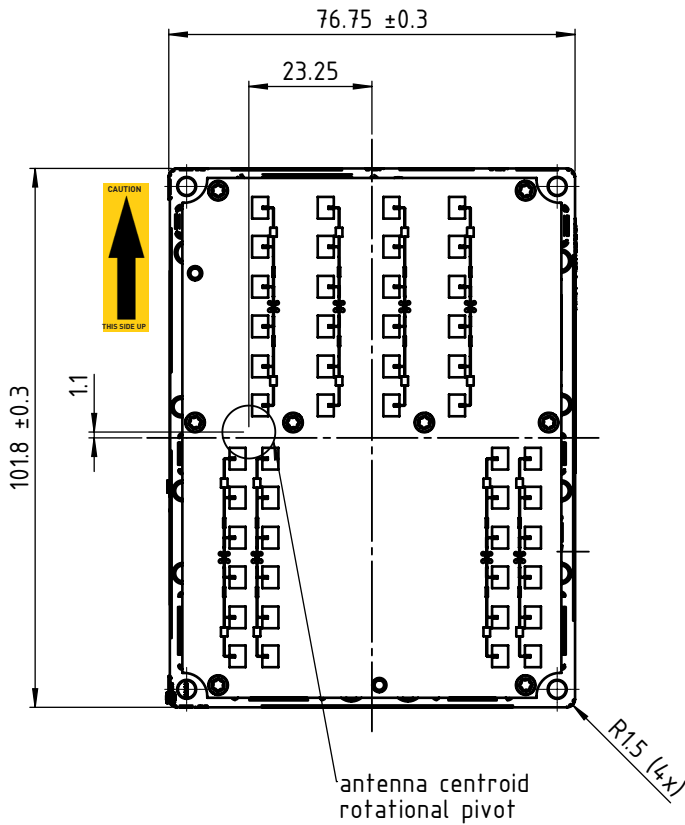

side view

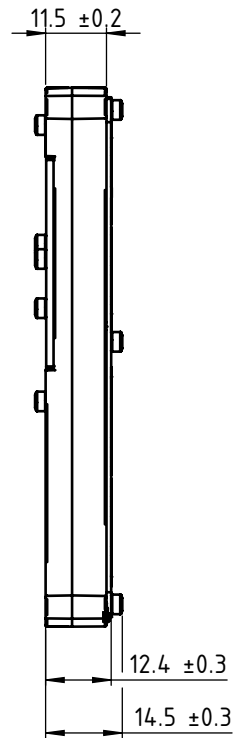

bottom view

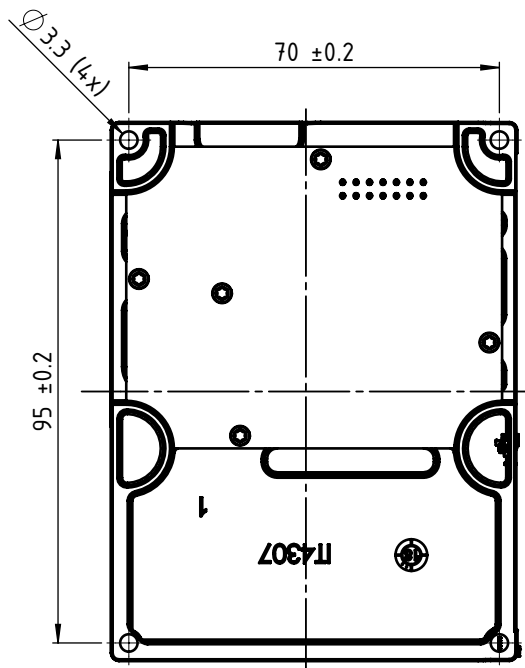

CONFIDENTIAL AND PROPRIETARY

The information contained in this document shall remain the sole and exclusive property of InnoSenT GmbH and shall not be disclosed by the recipient to third parties without prior consent of InnoSenT in writing.

LABELING

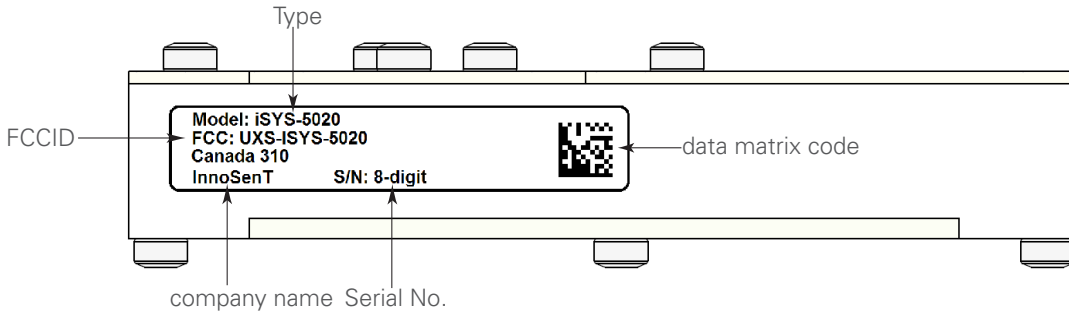

Annex A

The information that will be given below is only a rough overview; for details please contact the local approval agencies. An overview over the frequency bands in Europe can also be found in the REC 70-03 (Annex 6) which is available under www.ero.dk

Frequency Bands in Europe

Generally the iSYS-5020 standard version can be used for all countries in Europe except UK.

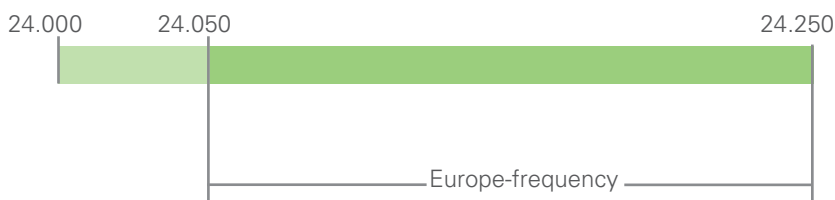

CONFIDENTIAL AND PROPRIETARY

The information contained in this document shall remain the sole and exclusive property of InnoSenT GmbH and shall not be disclosed by the recipient to third parties without prior consent of InnoSenT in writing.

Frequency Bands in US FCC 15.249

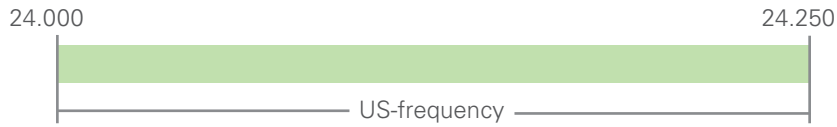

FCC approval

This device complies with Part 15 of the FCC Rules and with RSS-310 of Industry Canada. Operation is subject to the following two conditions:

- (1) this device may not cause harmful interference, and
- (2) this device must accept any interference received, including interference that may cause undesired operation.

Warning: Changes or modifications made to this equipment not expressly approved by InnoSenT GmbH may void the FCC authorization to operate this equipment.

Manufacturers of mobile or fixed devices incorporating iSYS-5020 modules are authorized to use the FCC Grants for their own final products according to the conditions referenced in these documents. In this case, the FCC label of the module shall be visible from the outside, or the host device shall bear a second label stating „Contains FCC ID: UXS-ISYS-5020“

Le présent appareil est conforme aux CNR d’Industrie Canada applicables aux appareils radio exempts de licence. L’exploitation est autorisée aux deux conditions suivantes:

- (1) l’appareil ne doit pas produire de brouillage, et
- (2) l’utilisateur de l’appareil doit accepter tout brouillage radioélectrique subi, même si le brouillage est susceptible d’en compromettre le fonctionnement.

NOTICE:

Changes or modifications made to this equipment not expressly approved by (manufacturer name) may void the FCC authorization to operate this equipment.

ESD-INFORMATION



This InnoSenT sensor is sensitive to damage from ESD. Normal precautions as usually applied to CMOS devices are sufficient when handling the device. Touching the signal output pins has to be avoided at any time before soldering or plugging the device into a motherboard.

CONFIDENTIAL AND PROPRIETARY

The information contained in this document shall remain the sole and exclusive property of InnoSenT GmbH and shall not be disclosed by the recipient to third parties without prior consent of InnoSenT in writing.

APPROVAL

This Data Sheet contains the technical specifications of the described product. Changes of the specification must be in written form. All previous versions of this Data Sheet are no longer valid.

VERSION	DATE	COMMENT
1.0	21.12.2017	initial release
1.1	10.01.2018	adding in mechanical drawing
1.2	20.04.2018	changing in mechanic; adding labeling; adding Annex A; adding Frequency Bands in Europe; adding Frequency Bands in US FCC 15.249
1.3	24.04.2018	changing in mechanic; adding labeling; adding in command interface; adding in output power; adding in detection range; changing in distance error; changing in angle error; adding transient current
1.4	07.05.2018	changing in install information
1.5	08.05.2018	changing in operating temperature

InnoSenT GmbH

Am Rödertor 30
97499 Donnersdorf
GERMANY

Tel.: +49 (0)9528 - 9518 - 0
E-Mail: info@innosent.de
URL: www.innosent.de