

Data sheet | Item number: 862-2633

4-conductor chassis-mount terminal strip; without ground contact; N-PE-L1;
3-pole; 1 snap-in foot per pole; 4 mm²; 4,00 mm²; white

www.wago.com/862-2633

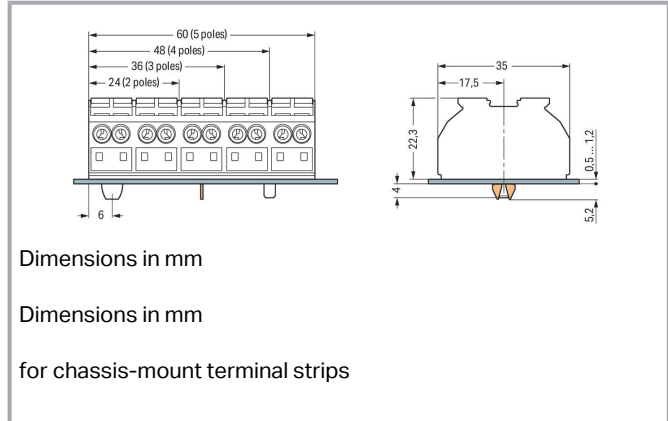
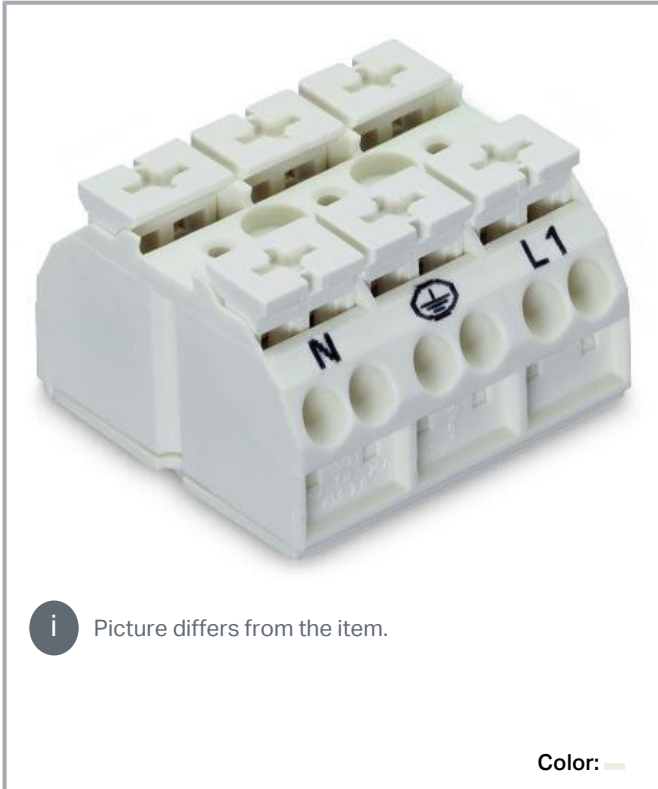

Subject to changes. Please also observe the further product documentation!

WAGO GmbH & Co. KG
Hansastr. 27
32423 Minden
Phone: +49571 887-0 | Fax: +49571 887-169
Email: info.de@wago.com | Web: www.wago.com

Do you have any questions about our products?
We are always happy to take your call at +49 (571) 887-44222.

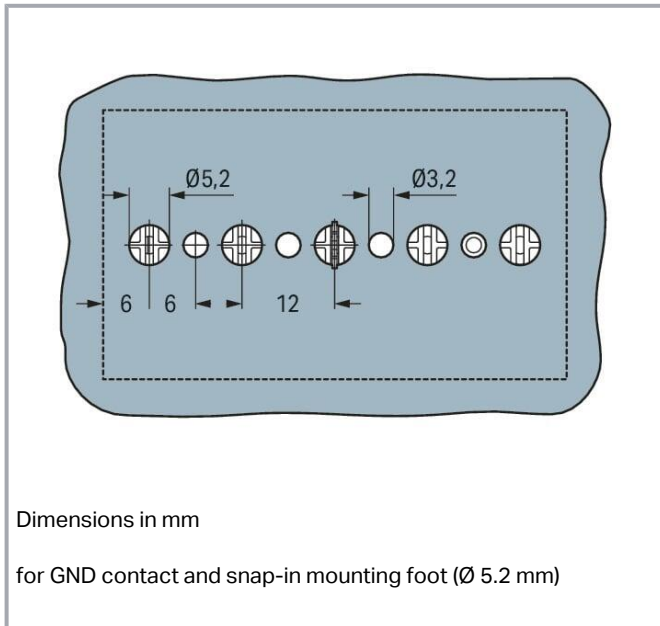

Data

Electrical data

Ratings per IEC/EN

Nominal voltage (III/3)	500 V
Rated impulse voltage (III/3)	6 kV
Rated current	32 A
Legend (ratings)	(III / 3) ≙ Overvoltage category III / Pollution degree 3

Connection data

Connection points	12
Total number of potentials	3
PE function	without PE contact

Connection 1

Connection technology	Push-in CAGE CLAMP®
Actuation type	Push-button
Connectable conductor materials	Copper
Solid conductor	0.5 ... 4 mm ² / 20 ... 12 AWG
Solid conductor; push-in termination	0.75 ... 4 mm ² / 18 ... 12 AWG

Subject to changes. Please also observe the further product documentation!



Stranded conductor	0.5 ... 4 mm ² / 20 ... 12 AWG
Fine-stranded conductor	0.5 ... 4 mm ² / 20 ... 12 AWG
Fine-stranded conductor; with insulated ferrule	0.5 ... 1.5 mm ² / 20 ... 16 AWG
Fine-stranded conductor; with ferrule; push-in termination	0.75 mm ² / 18 AWG
Note (conductor cross-section)	Depending on the conductor characteristic, a conductor with a smaller cross-section can also be inserted via push-in termination.
Strip length	10 ... 11 mm / 0.39 ... 0.43 inches
Pole number	3
Wiring direction	Side-entry wiring

Physical data

Pin spacing	12 mm / 0.472 inches
Width	36 mm / 1.417 inches
Height from the surface	22.3 mm / 0.878 inches
Depth	35 mm / 1.378 inches

Mechanical Data

Marking	N- $\frac{1}{2}$ -L1
Mounting type	Snap-in foot

Material Data

Note (material data)	Information on material specifications can be found here
Color	white
Material group	I
Insulation material	Polyamide (PA66)
Flammability class per UL94	V0
Fire load	0.396 MJ
Halogen-free	Yes
Weight	20.8 g

Commercial data

eCl@ss 10.0	27-14-11-06
eCl@ss 9.0	27-14-11-06
ETIM 8.0	EC001284
ETIM 7.0	EC001284

Subject to changes. Please also observe the further product documentation!





PU (SPU)	250 pcs
Packaging type	bag
Country of origin	DE
GTIN	4044918510257
Customs tariff number	85369010000

Environmental Product Compliance

RoHS Compliance Status	Compliant, No Exemption
------------------------	-------------------------

Approvals / Certificates

General approvals

Logo	Approval	Additional Approval Text	Certificate name
	CCA DEKRA Certification B.V.	EN 60947	2146425.01
	CCA DEKRA Certification B.V.	EN 60947	NTR NL 6912
	CSA DEKRA Certification B.V.	C22.2 No. 158	1505030
	ENEC 15 UL International Germany GmbH	EN 60998	143856-01
	UL UL International Germany GmbH	UL 1059	E45172

Declarations of conformity and manufacturer's declarations



Logo	Approval	Additional Approval Text	Certificate name
	EU-Declaration of Conformity WAGO GmbH & Co. KG	-	-

Subject to changes. Please also observe the further product documentation!



UK-Declaration of Conformity
WAGO GmbH & Co. KG

Approvals for marine applications

Logo	Approval	Additional Approval Text	Certificate name
	DNV GL Det Norske Veritas, Germanischer Lloyd	-	TAE00001V2
	LR Lloyds Register	EN 60947	91/20112 (E9)

Optional accessories

Testing and measuring

Testing accessories



Item no.: 210-136
Test plug; 2 mm Ø; with 500 mm cable; red

www.wago.com/210-136

Marking accessories

Marking strip



Item no.: 709-178
Marking strips; on reel; 7.5 mm wide; not stretchable; plain; snap-on type; white

www.wago.com/709-178



Item no.: 709-177
Marking strips; on reel; 7.5 mm wide; not stretchable; plain; snap-on type; translucent

www.wago.com/709-177

Ferrule

Ferrule

Item no.: 216-142
Ferrule; Sleeve for 0.75 mm² / 18 AWG; uninsulated; electro-tin plated; electrolytic copper; gastight crimped; acc. to DIN 46228, Part 1/08.92

www.wago.com/216-142

Item no.: 216-143
Ferrule; Sleeve for 1 mm² / AWG 18; uninsulated; electro-tin plated; electrolytic copper; gastight crimped; acc. to DIN 46228, Part 1/08.92





www.wago.com/216-143

Item no.: 216-141

Subject to changes. Please also observe the further product documentation!

WAGO GmbH & Co. KG
Hansastr. 27
32423 Minden
Phone: +49571 887-0 | Fax: +49571 887-169
Email: info.de@wago.com | Web: www.wago.com

Do you have any questions about our products?
We are always happy to take your call at +49 (571) 887-44222.

	Ferrule; Sleeve for 0.5 mm ² / 20 AWG; uninsulated; electro-tin plated; electrolytic copper; gastight crimped; acc. to DIN 46228, Part 1/08.92	www.wago.com/216-141
	Item no.: 216-144 Ferrule; Sleeve for 1.5 mm ² / AWG 16; uninsulated; electro-tin plated; electrolytic copper; gastight crimped; acc. to DIN 46228, Part 1/08.92; silver-colored	www.wago.com/216-144
	Item no.: 216-241 Ferrule; Sleeve for 0.5 mm ² / 20 AWG; insulated; electro-tin plated; electrolytic copper; gastight crimped; acc. to DIN 46228, Part 4/09.90; white	www.wago.com/216-241
	Item no.: 216-242 Ferrule; Sleeve for 0.75 mm ² / 18 AWG; insulated; electro-tin plated; electrolytic copper; gastight crimped; acc. to DIN 46228, Part 4/09.90; gray	www.wago.com/216-242
	Item no.: 216-243 Ferrule; Sleeve for 1 mm ² / AWG 18; insulated; electro-tin plated; electrolytic copper; gastight crimped; acc. to DIN 46228, Part 4/09.90; red	www.wago.com/216-243
	Item no.: 216-244 Ferrule; Sleeve for 1.5 mm ² / AWG 16; insulated; electro-tin plated; electrolytic copper; gastight crimped; acc. to DIN 46228, Part 4/09.90; black	www.wago.com/216-244

Jumpers

Jumper		
	Item no.: 862-482 Jumper; for conductor entry; insulated; black	www.wago.com/862-482

Tool

Operating tool		
	Item no.: 210-720 Operating tool; Blade: 3.5 x 0.5 mm; with a partially insulated shaft; multicoloured	www.wago.com/210-720

Downloads

Documentation

Bid Text

862-2633 X81 - Datei	2019 Feb 19	xml 3.7 kB	Download
862-2633 doc - Datei	2017 Jun 12	doc 25.1 kB	Download

Additional Information

Technical Section Technical explanations	pdf 2.2 MB	Download
---------------------------------------------	---------------	----------

Subject to changes. Please also observe the further product documentation!



CAD/CAE-Data

CAE data

EPLAN Data Portal 862-2633	URL	Download
----------------------------	---------------------	--------------------------

WSCAD Universe 862-2633	URL	Download
-------------------------	---------------------	--------------------------

ZUKEN Portal 862-2633	URL	Download
-----------------------	---------------------	--------------------------

CAD data

2D/3D Models 862-2633	URL	Download
-----------------------	---------------------	--------------------------

Environmental Product Compliance

Compliance Search

Environmental Product Compliance 862-2633	URL	Download
-------------------------------------------	---------------------	--------------------------

4-conductor chassis-mount terminal strip; without ground contact; N-PE-L1; 3-pole;
1 snap-in foot per pole; 4 mm²; 4,00 mm²; white

Installation Notes

Subject to changes. Please also observe the further product documentation!

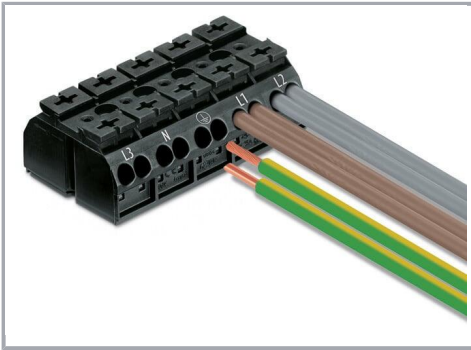

Cost-effective features:

WAGO's 862 Series Chassis-Mount Terminal Strips were developed specifically to minimize wiring costs, while accommodating requirements for flexible mounting, multiple connection points and easy usage:

- Equipped with Push-in CAGE CLAMP®, the 862 Series connects up to four conductors sized 0.5 to 4 mm² (20 ... 12 AWG). Due to multiple connection points per pole, different conductor sizes can be used within the same terminal block position.
- For factory wiring, Push-in CAGE CLAMP® Connection Technology allows solid conductors, fine-stranded conductors with ferrules or ultrasonically bonded conductors from 0.5 ... 4 mm² (20 ... 12 AWG) to be terminated by simply pushing them into unit (length of bonded conductor end: min. 10 mm).
- Convenient automatic grounding contact (optional)
- Snap-in mounting feet for fast assembly
- Push-buttons for easy installation with an operating tool or by hand
- Built-in test points simplify testing with 2 mm Ø test plug
- Standard marking for each pole, or custom marking for large orders

Conductor termination

Subject to changes. Please also observe the further product documentation!

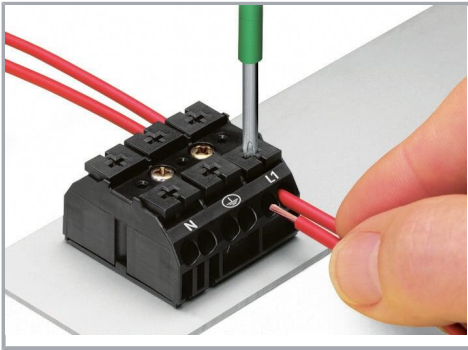

Terminating four conductors per pole – solid and fine-stranded.

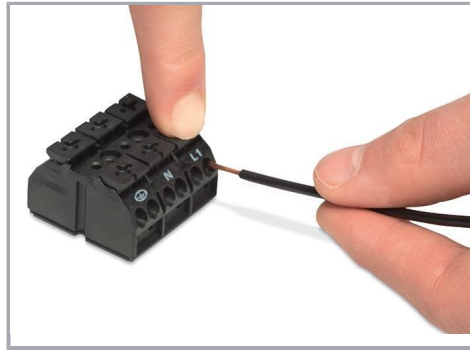

Inserting a conductor via push-button.

Commoning



Commoning using a comb-style jumper bar (862-482).

Testing

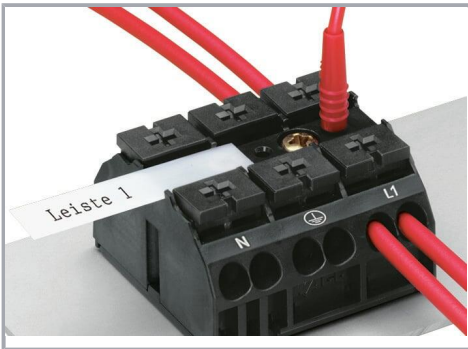

Testing with a 2 mm Ø test plug (max. 42 V).

Subject to changes. Please also observe the further product documentation!

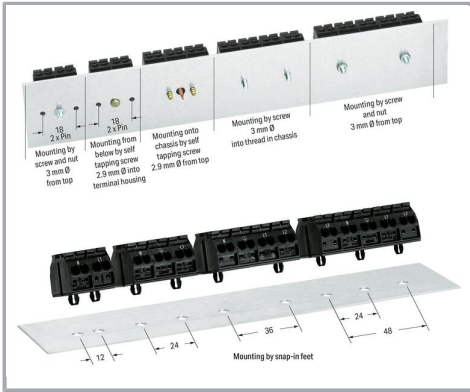

Dimensions in mm

Marking

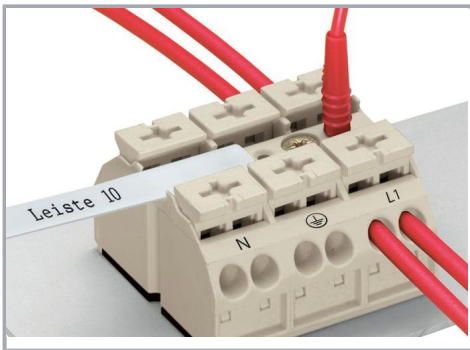

Marking by direct, one-side printing and marking strips

Subject to changes. Please also observe the further product documentation!