

**NOTES:**

1. MATERIALS:  
HOUSING: 30% GLASS FILLED NYLON 4/6, U.L. 94V-0, COLOR: BLACK.  
TERMINAL: ALLOY 151 PLATING: TIN-LEAD OVER NICKEL.
2. PRODUCT SPEC.: PSX-42815-0001
3. ALL DIMENSIONS SHOWN FOR REFERENCE ONLY.
4. USES STANDARD 42874 MINI-FIT SR. HEADER TERMINALS.
5. PART MATES WITH MOLEX RECEPTACLE 43914.

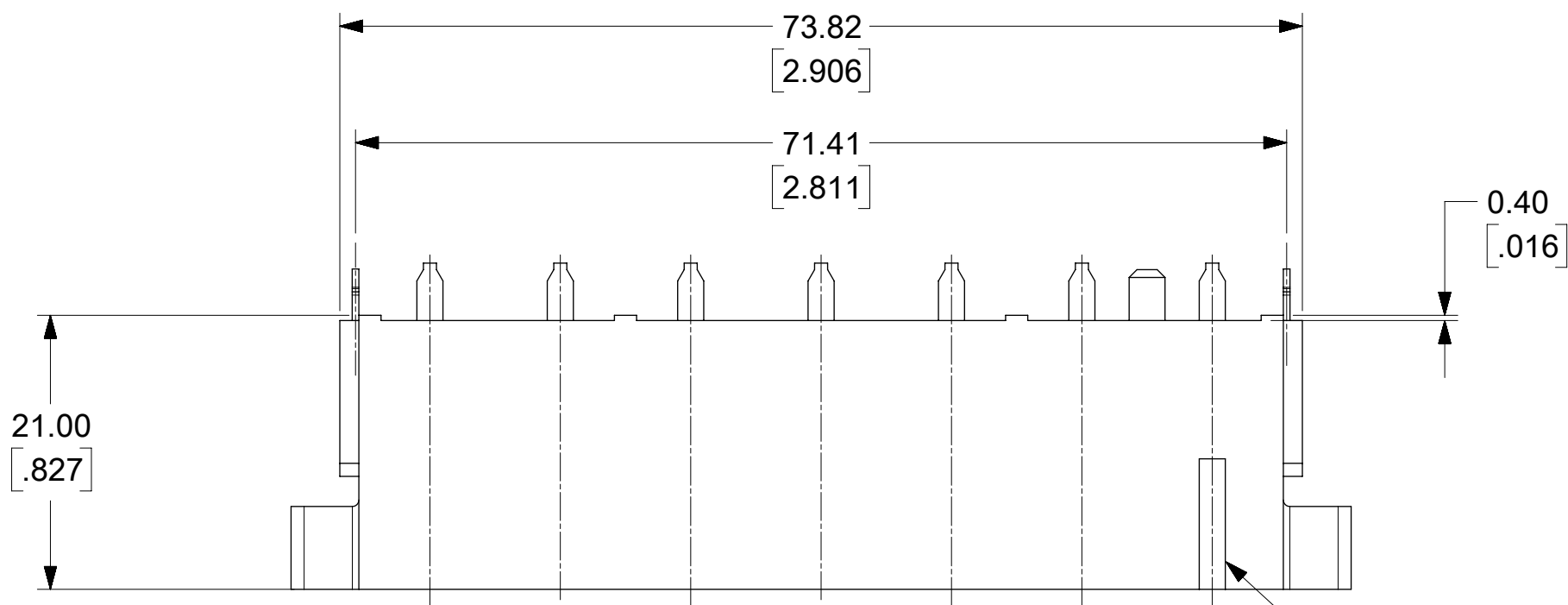

**CIRCUIT #1 DESIGNATION**

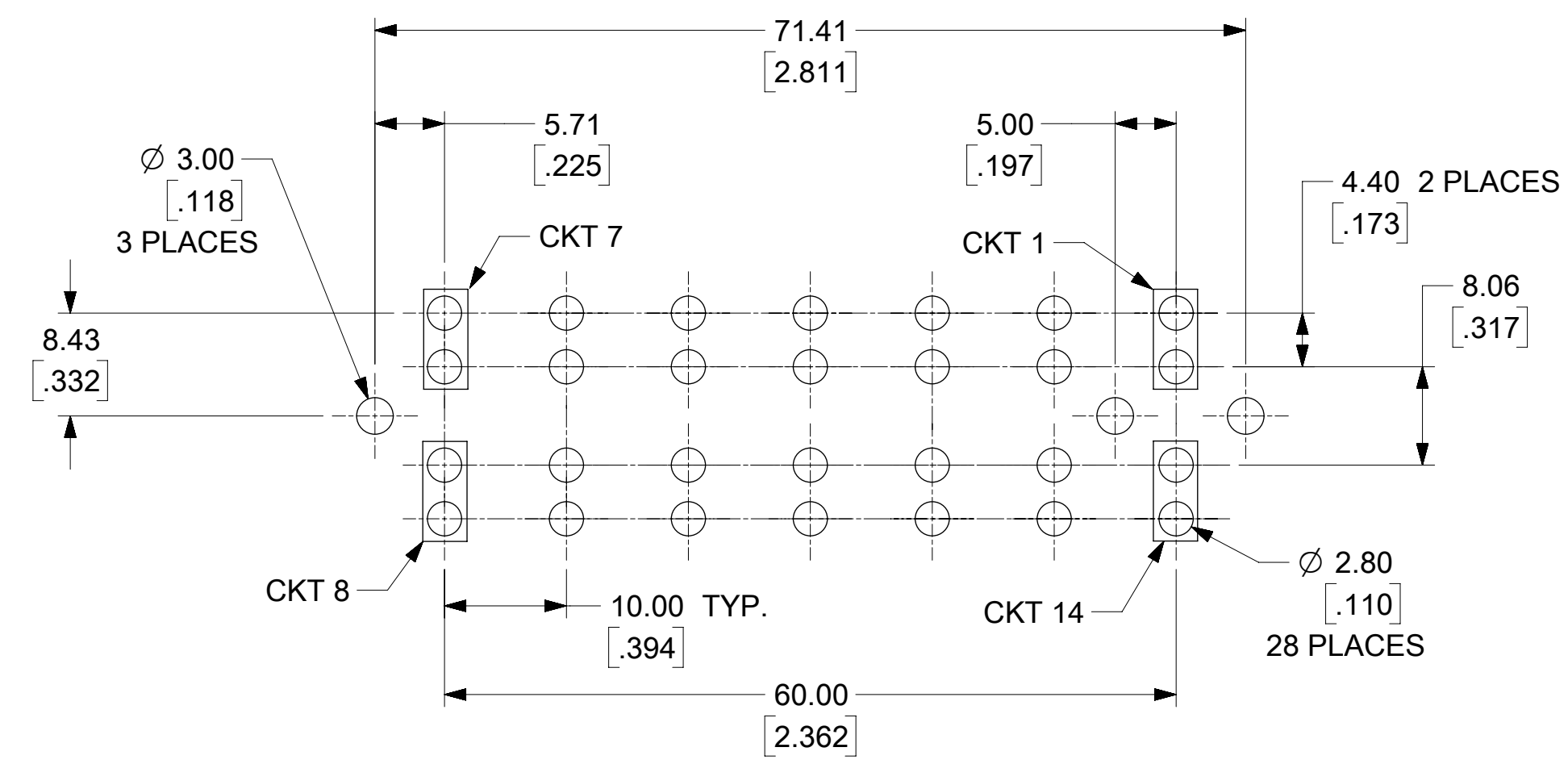
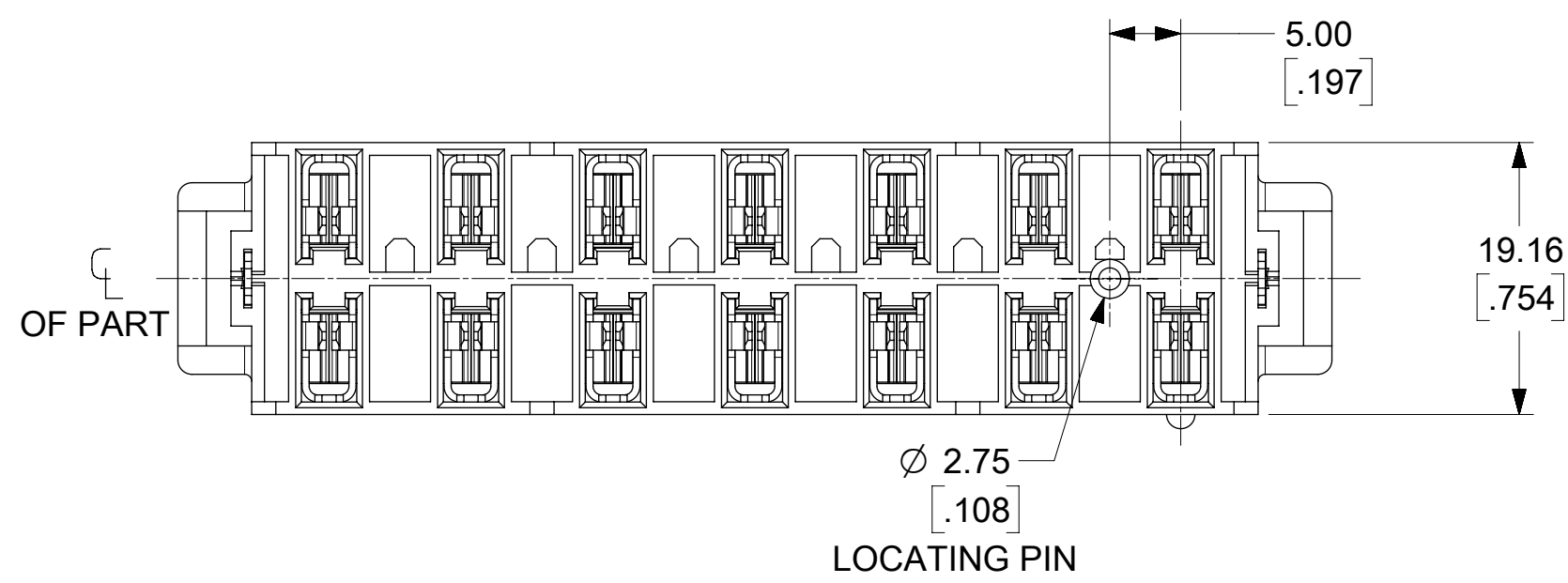
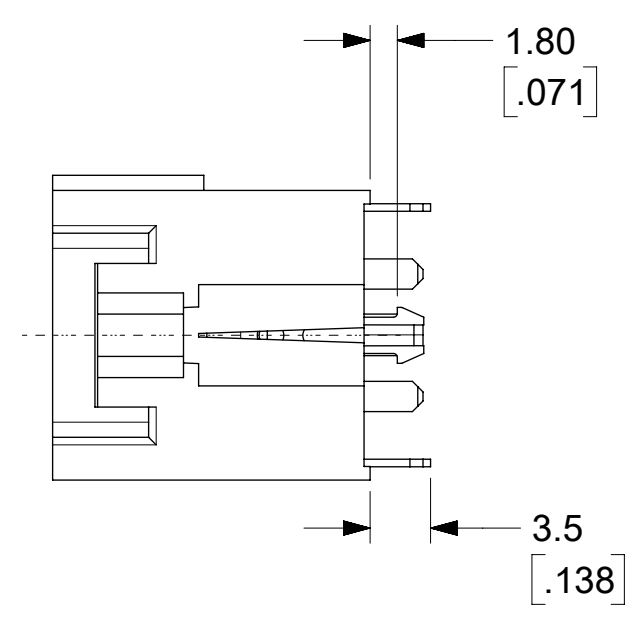
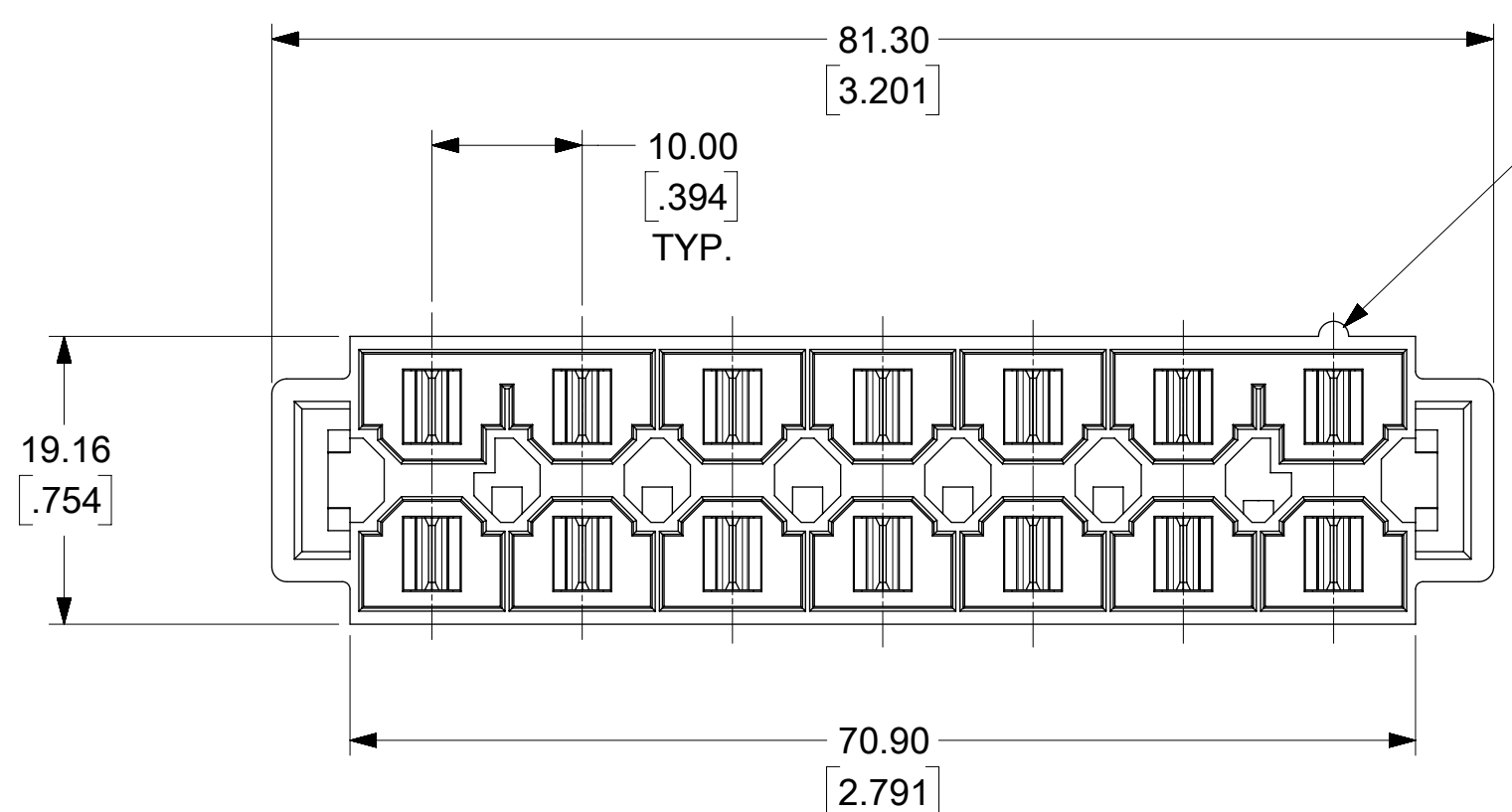

**PROPOSAL**

THIS DRAWING CONTAINS INFORMATION THAT IS PROPRIETARY TO MOLEX ELECTRONIC TECHNOLOGIES, LLC AND SHOULD NOT BE USED WITHOUT WRITTEN PERMISSION													
DIMENSION UNITS		SCALE		CURRENT REV DESC: MIGRATED TO ECTR									
MM		2:1		<b>molex</b> VERTICAL HEADER 14 CIRCUIT (MINI-FIT SR.) PRODUCT CUSTOMER DRAWING									
GENERAL TOLERANCES (UNLESS SPECIFIED)										EC NO: 604054		2018/08/22	
4 PLACES		±								DRWN: ABABU01		2018/09/06	
3 PLACES		±								CHK'D: ISHWARG		2018/09/06	
2 PLACES		±								APPR: ISHWARG		2018/09/06	
1 PLACE		±		INITIAL REVISION:				DOCUMENT NUMBER					
0 PLACES		±		DRWN: COMERCI		1997/05/08		SD-43915-001					
ANGULAR TOL		± 0.5 °		APPR: FRY		1997/05/12		DOC TYPE DOC PART REVISION					
DRAFT WHERE APPLICABLE MUST REMAIN WITHIN DIMENSIONS				THIRD ANGLE PROJECTION		DRAWING		SHEET NUMBER					
				C-SIZE		43915		1 OF 1					
MATERIAL NUMBER				CUSTOMER		SERIES		SHEET NUMBER					
439151005				GENERAL MARKET		43915		1 OF 1					

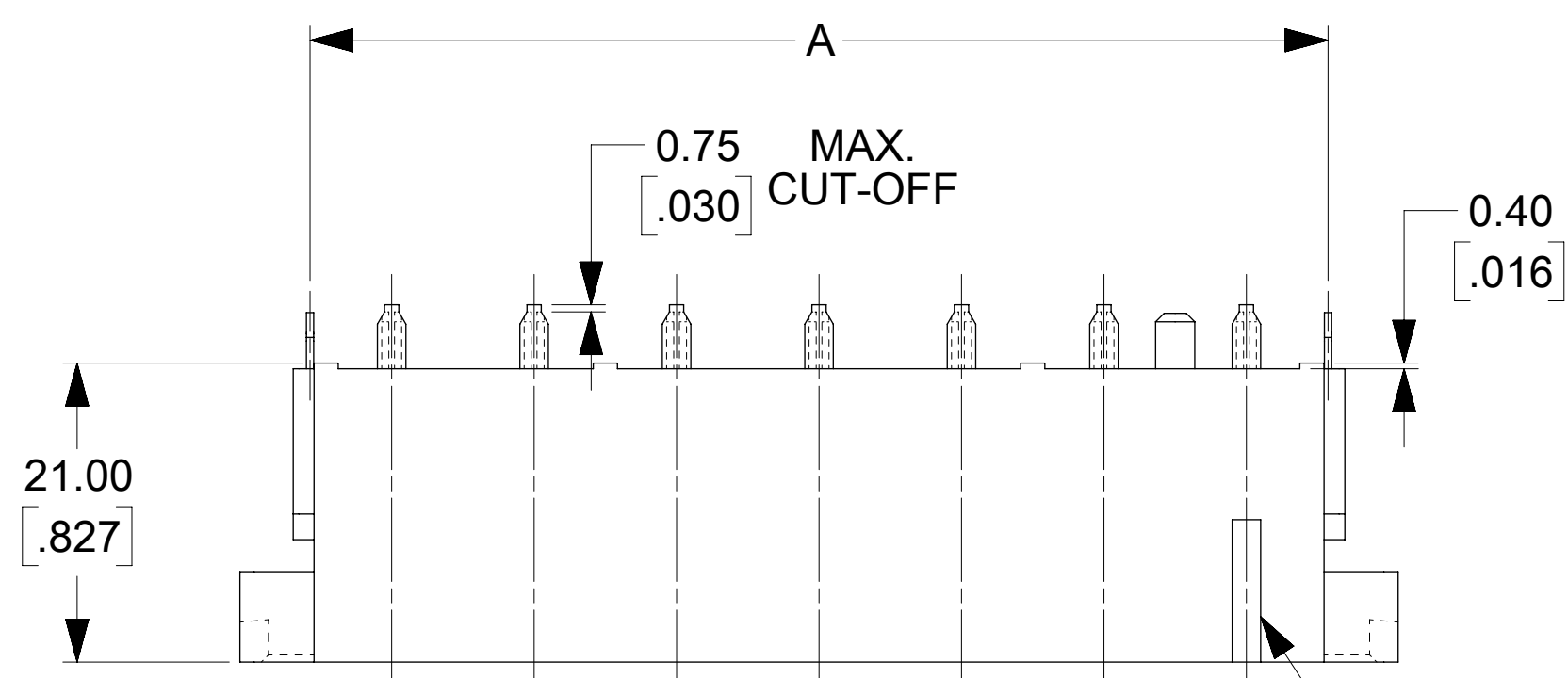
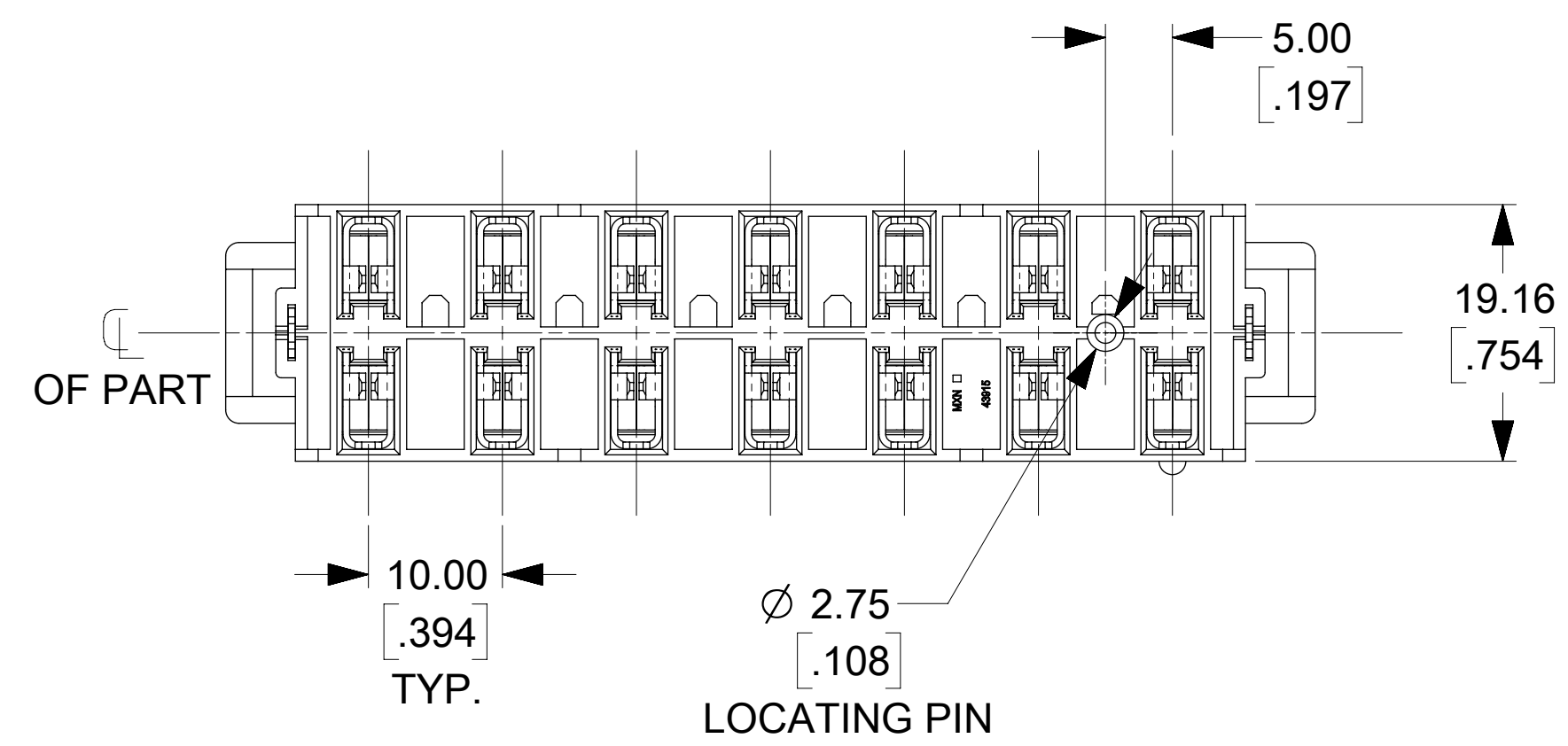

LEGEND:  
439151\*\*\*

PLATING:

- 1 OR 9 = TIN PLATING
- 2 = SELECT GOLD AND SELECT TIN OVER NICKEL
- 4 = SELECT SILVER AND SELECT TIN OVER NICKEL

POLARIZING SLOTS (2 PLACES)  
(SEE CHART AND SEE NOTE 6)

MATING AREA  
(SEE NOTE 5)

CIRCUIT #1 DESIGNATION

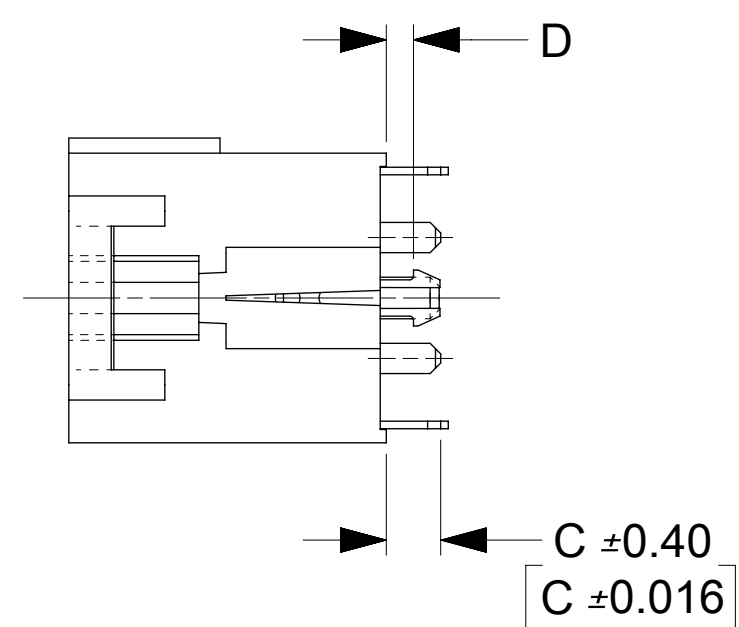
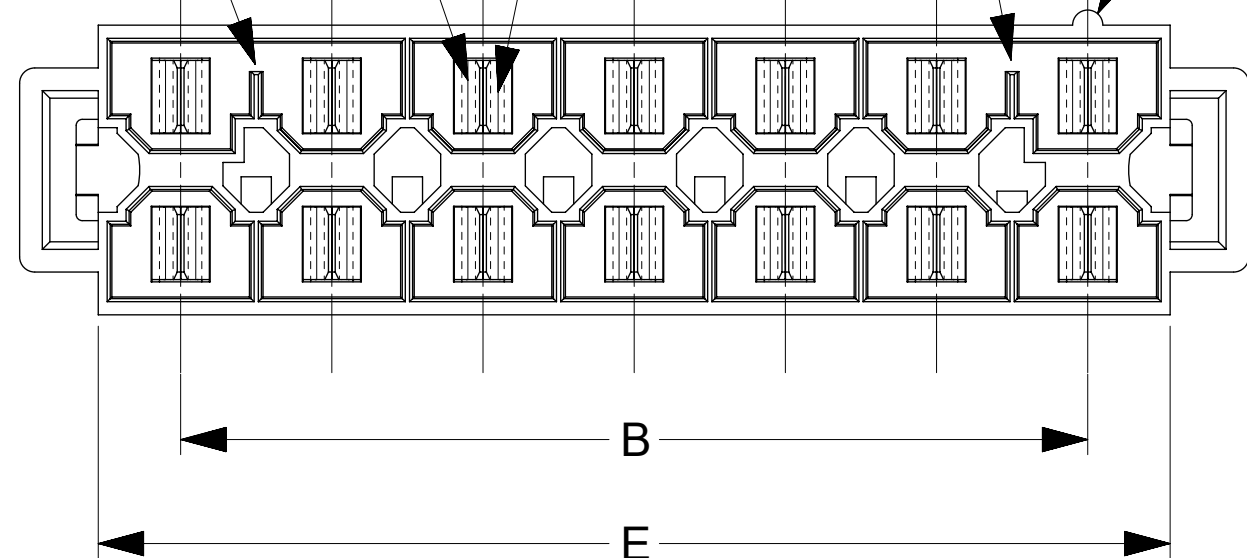

NOTES:

1. MATERIALS:  
HOUSING: 30% GLASS FILLED NYLON 4/6, U.L.94V-0, COLOR: BLACK.  
TERMINAL: ALLOY 151  
PLATING: \*TIN OVER NICKEL.  
OR SELECT GOLD AND SELECT TIN OVER NICKEL  
OR SELECT SILVER AND SELECT TIN OVER NICKEL  
(SEE CHART)  
\* THE PRIMARY SHIPPING CARTON WILL BE LABELED  
'COMPLAINT TO RoHS DIRECTIVE 2002/95/EC  
AND ELV ANNEX II OF DIRECTIVE 2000/53/EC'.  
CARTONS WITHOUT THIS LABEL MAY CONTAIN  
PRODUCT WITH TIN-LEAD.
2. PRODUCT SPEC.: PS-42815-0001
3. PARTS ARE NOT TO BE MATED OR UNMATED WHILE CIRCUITS ARE LIVE.
4. PART MATES WITH MOLEX RECEPTACLE 43914.
5. WHEN USING OVERALL TIN PLATED TERMINALS:  
FOR APPLICATIONS INVOLVING VIBRATION AND/OR THERMAL CYCLING, MOLEX STRONGLY  
RECOMMENDS THE USE OF NYE LUBRICANT (NYOGEL 760G) ON THE MATING  
SURFACES OF THE TERMINAL.
6. POLARIZING SLOTS TO BE LOCATED BETWEEN CIRCUITS ON EITHER END  
OF HOUSING OF THE CIRCUIT 1 ROW. AS SHOWN.  
EXCEPTION: THE 6 CIRCUIT HOUSING WILL HAVE A SINGLE SLOT ON THE CIRCUIT 1 END ONLY.
7. PARTS CONFORMS TO CLASS 'B' REQUIREMENTS OF COSMETIC SPEC-PS-45499-002.
8. REFER AS-42815-001 FOR TIN PLATED TERMINALS RECOMMENDED LUBRICATION PROCEDURE.

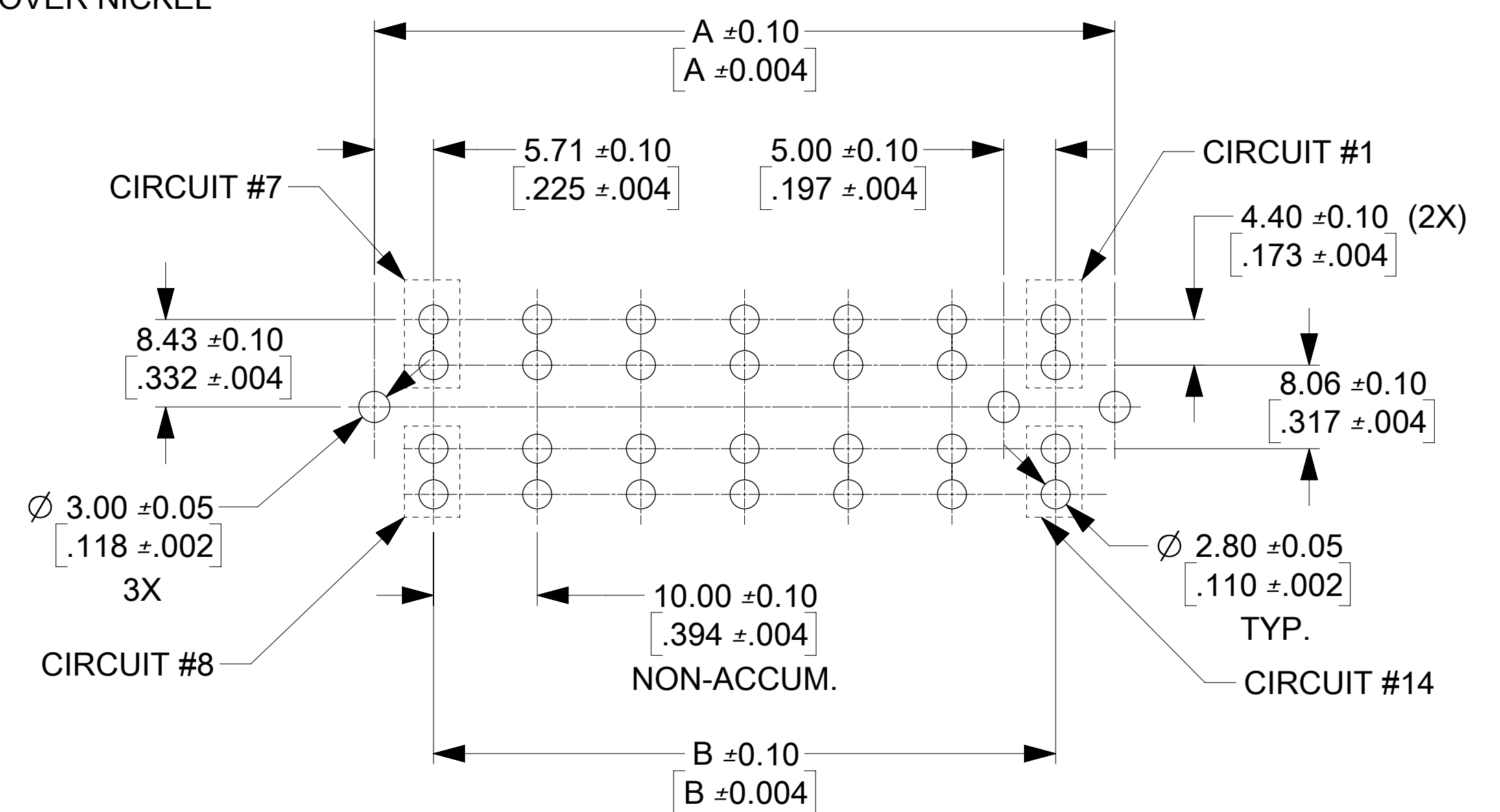

RECOMMENDED P.C. BOARD PLATED-THRU HOLE LAYOUT  
(14 CIRCUIT LAYOUT SHOWN)

THIS DRAWING CONTAINS INFORMATION THAT IS PROPRIETARY TO MOLEX ELECTRONIC TECHNOLOGIES, LLC AND SHOULD NOT BE USED WITHOUT WRITTEN PERMISSION									
DIMENSION UNITS <b>MM/IN</b>		SCALE <b>2:1</b>		CURRENT REV DESC: MIGRATED TO ECTR					
GENERAL TOLERANCES (UNLESS SPECIFIED)				EC NO: 611033					
		MM	INCH	DRWN: ME		2018/11/14			
4 PLACES ±				CHK'D: MKAMATHMARAK		2019/01/25			
3 PLACES ±			± 0.008	APPR: ISHWARG		2019/02/08			
2 PLACES ±		0.2		INITIAL REVISION:					
1 PLACE ±				DRWN: COMERCI		1997/08/21			
0 PLACES ±				APPR: KPRASAD		2009/02/09			
ANGULAR TOL ±		0.5 °		DRAFT WHERE APPLICABLE MUST REMAIN WITHIN DIMENSIONS		THIRD ANGLE PROJECTION		DRAWING SERIES	
				D-SIZE		43915		MATERIAL NUMBER CUSTOMER	
				SEE CHART		GENERAL MARKET		SHEET NUMBER	
				1 OF 2					

**molex**

VERTICAL HEADER  
DUAL ROW, 6-14 CIRCUIT MINI-FIT SR.

PRODUCT CUSTOMER DRAWING

DOCUMENT NUMBER: **SD-43915-002**    DOC TYPE: PSD    DOC PART: 001    REVISION: F

MATERIAL NUMBER	CIRCUITS	DIM .A	DIM. B	DIM. C	DIM. D	DIM. E	PCB THICKNESS	QUANTITY OF POLARIZING SLOTS	TERMINAL PLATING	STATUS
L 439151201	6	31.41/[1.237]	20.00/[.787]	3.50/[.137]	1.80/[.071]	30.90/[1.217]	1.57/[.062]	1	SELECT GOLD (SEE LEGEND)	ACTIVE
439151202	8	41.41/[1.630]	30.00/[1.181]	3.50/[.137]	1.80/[.071]	40.90/[1.610]		2		
439151203	10	51.41/[2.024]	40.00/[1.575]	3.50/[.137]	1.80/[.071]	50.90/[2.004]		2		
439151204	12	61.41/[2.418]	50.00/[1.969]	3.50/[.137]	1.80/[.071]	60.90/[2.398]		2		
K 439151205	14	71.41/[2.811]	60.00/[2.362]	3.50/[.137]	1.80/[.071]	70.90/[2.791]	2.36/[.093]	2		
439151206	6	31.41/[1.237]	20.00/[.787]	5.10/[.201]	2.60/[.102]	30.90/[1.217]		1		
439151207	8	41.41/[1.630]	30.00/[1.181]	5.10/[.201]	2.60/[.102]	40.90/[1.610]		2		
439151208	10	51.41/[2.024]	40.00/[1.575]	5.10/[.201]	2.60/[.102]	50.90/[2.004]		2		
J 439151209	12	61.41/[2.418]	50.00/[1.969]	5.10/[.201]	2.60/[.102]	60.90/[2.398]	3.18/[.125]	2		
439151210	14	71.41/[2.811]	60.00/[2.362]	5.10/[.201]	2.60/[.102]	70.90/[2.791]		2		
439151211	6	31.41/[1.237]	20.00/[.787]	5.10/[.201]	3.40/[.134]	30.90/[1.217]		1		
439151212	8	41.41/[1.630]	30.00/[1.181]	5.10/[.201]	3.40/[.134]	40.90/[1.610]		2		
H 439151213	10	51.41/[2.024]	40.00/[1.575]	5.10/[.201]	3.40/[.134]	50.90/[2.004]	6.35/[.250]	2		
439151214	12	61.41/[2.418]	50.00/[1.969]	5.10/[.201]	3.40/[.134]	60.90/[2.398]		2		
439151215	14	71.41/[2.811]	60.00/[2.362]	5.10/[.201]	3.40/[.134]	70.90/[2.791]		2		
439151216	6	31.41/[1.237]	20.00/[.787]	8.30/[.327]	6.58/[.259]	30.90/[1.217]		1		
G 439151217	8	41.41/[1.630]	30.00/[1.181]	8.30/[.327]	6.58/[.259]	40.90/[1.610]	2.36/[.093]	2		
439151218	10	51.41/[2.024]	40.00/[1.575]	8.30/[.327]	6.58/[.259]	50.90/[2.004]		2		
439151219	12	61.41/[2.418]	50.00/[1.969]	8.30/[.327]	6.58/[.259]	60.90/[2.398]		2		
439151220	14	71.41/[2.811]	60.00/[2.362]	8.30/[.327]	6.58/[.259]	70.90/[2.791]		2		
F 439151221	10	51.41/[2.024]	40.00/[1.575]	3.50/[.137]	2.60/[.102]	50.90/[2.004]	1.57/[.062]	2		
H 439151401	6	31.41/[1.237]	20.00/[.787]	3.50/[.137]	1.80/[.071]	30.90/[1.217]		1		
439151402	8	41.41/[1.630]	30.00/[1.181]	3.50/[.137]	1.80/[.071]	40.90/[1.610]		2		
439151403	10	51.41/[2.024]	40.00/[1.575]	3.50/[.137]	1.80/[.071]	50.90/[2.004]		2		
G 439151404	12	61.41/[2.418]	50.00/[1.969]	3.50/[.137]	1.80/[.071]	60.90/[2.398]	2.36/[.093]	2		
439151405	14	71.41/[2.811]	60.00/[2.362]	3.50/[.137]	1.80/[.071]	70.90/[2.791]		2		
439151406	6	31.41/[1.237]	20.00/[.787]	5.10/[.201]	2.60/[.102]	30.90/[1.217]		1		
439151407	8	41.41/[1.630]	30.00/[1.181]	5.10/[.201]	2.60/[.102]	40.90/[1.610]		2		
F 439151408	10	51.41/[2.024]	40.00/[1.575]	5.10/[.201]	2.60/[.102]	50.90/[2.004]	3.18/[.125]	2		
439151409	12	61.41/[2.418]	50.00/[1.969]	5.10/[.201]	2.60/[.102]	60.90/[2.398]		2		
439151410	14	71.41/[2.811]	60.00/[2.362]	5.10/[.201]	2.60/[.102]	70.90/[2.791]		2		
439151411	6	31.41/[1.237]	20.00/[.787]	5.10/[.201]	3.40/[.134]	30.90/[1.217]		1		
E 439151412	8	41.41/[1.630]	30.00/[1.181]	5.10/[.201]	3.40/[.134]	40.90/[1.610]	6.35/[.250]	2		
439151413	10	51.41/[2.024]	40.00/[1.575]	5.10/[.201]	3.40/[.134]	50.90/[2.004]		2		
439151414	12	61.41/[2.418]	50.00/[1.969]	5.10/[.201]	3.40/[.134]	60.90/[2.398]		2		
439151415	14	71.41/[2.811]	60.00/[2.362]	5.10/[.201]	3.40/[.134]	70.90/[2.791]		2		
D 439151416	6	31.41/[1.237]	20.00/[.787]	8.30/[.327]	6.58/[.259]	30.90/[1.217]	2.36/[.093]	1		
439151417	8	41.41/[1.630]	30.00/[1.181]	8.30/[.327]	6.58/[.259]	40.90/[1.610]		2		
439151418	10	51.41/[2.024]	40.00/[1.575]	8.30/[.327]	6.58/[.259]	50.90/[2.004]		2		
439151419	12	61.41/[2.418]	50.00/[1.969]	8.30/[.327]	6.58/[.259]	60.90/[2.398]		2		
C 439151420	14	71.41/[2.811]	60.00/[2.362]	8.30/[.327]	6.58/[.259]	70.90/[2.791]	1.57/[.062]	2		
E 439151421	10	51.41/[2.024]	40.00/[1.575]	3.50/[.137]	2.60/[.102]	50.90/[2.004]		2		
439151101	6	31.41/[1.237]	20.00/[.787]	3.50/[.137]	1.80/[.071]	30.90/[1.217]		1		
439151102	8	41.41/[1.630]	30.00/[1.181]	3.50/[.137]	1.80/[.071]	40.90/[1.610]		2		
B 439151103	10	51.41/[2.024]	40.00/[1.575]	3.50/[.137]	1.80/[.071]	50.90/[2.004]	2.36/[.093]	2		
439151104	12	61.41/[2.418]	50.00/[1.969]	3.50/[.137]	1.80/[.071]	60.90/[2.398]		2		
439151105	14	71.41/[2.811]	60.00/[2.362]	3.50/[.137]	1.80/[.071]	70.90/[2.791]		2		
439151106	6	31.41/[1.237]	20.00/[.787]	5.10/[.201]	2.60/[.102]	30.90/[1.217]		1		
A 439151107	8	41.41/[1.630]	30.00/[1.181]	5.10/[.201]	2.60/[.102]	40.90/[1.610]	3.18/[.125]	2		
439151108	10	51.41/[2.024]	40.00/[1.575]	5.10/[.201]	2.60/[.102]	50.90/[2.004]		2		
439151109	12	61.41/[2.418]	50.00/[1.969]	5.10/[.201]	2.60/[.102]	60.90/[2.398]		2		
439151110	14	71.41/[2.811]	60.00/[2.362]	5.10/[.201]	2.60/[.102]	70.90/[2.791]		2		
Z 439151111	6	31.41/[1.237]	20.00/[.787]	5.10/[.201]	3.40/[.134]	30.90/[1.217]	6.35/[.250]	1		
439151112	8	41.41/[1.630]	30.00/[1.181]	5.10/[.201]	3.40/[.134]	40.90/[1.610]		2		
439151113	10	51.41/[2.024]	40.00/[1.575]	5.10/[.201]	3.40/[.134]	50.90/[2.004]		2		
439151114	12	61.41/[2.418]	50.00/[1.969]	5.10/[.201]	3.40/[.134]	60.90/[2.398]		2		
Y 439151115	14	71.41/[2.811]	60.00/[2.362]	5.10/[.201]	3.40/[.134]	70.90/[2.791]	1.57/[.062]	2		
439151116	6	31.41/[1.237]	20.00/[.787]	8.30/[.327]	6.58/[.259]	30.90/[1.217]		1		
439151117	8	41.41/[1.630]	30.00/[1.181]	8.30/[.327]	6.58/[.259]	40.90/[1.610]		2		
439151118	10	51.41/[2.024]	40.00/[1.575]	8.30/[.327]	6.58/[.259]	50.90/[2.004]		2		
X 439151119	12	61.41/[2.418]	50.00/[1.969]	8.30/[.327]	6.58/[.259]	60.90/[2.398]	2.36/[.093]	2		
439151120	14	71.41/[2.811]	60.00/[2.362]	8.30/[.327]	6.58/[.259]	70.90/[2.791]		2		
439151121	10	51.41/[2.024]	40.00/[1.575]	3.50/[.137]	2.60/[.102]	50.90/[2.004]		2		
439151905	14	71.41/[2.811]	60.00/[2.362]	3.50/[.137]	1.80/[.071]	70.90/[2.791]		1.57/[.062]	2	

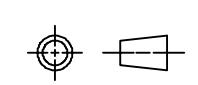
THIS DRAWING CONTAINS INFORMATION THAT IS PROPRIETARY TO MOLEX ELECTRONIC TECHNOLOGIES, LLC AND SHOULD NOT BE USED WITHOUT WRITTEN PERMISSION															
DIMENSION UNITS		SCALE		CURRENT REV DESC: MIGRATED TO ECTR											
MM/IN		1:1		 VERTICAL HEADER DUAL ROW, 6-14 CIRCUIT MINI-FIT SR.											
GENERAL TOLERANCES (UNLESS SPECIFIED)										EC NO: 611033		DRWN: ME		2018/11/14	
4 PLACES ±		±								CHK'D: MKAMATHMARAK		2019/01/25		2019/02/08	
2 PLACES ±		0.2 ±								APPR: ISHWARG		2019/02/08		PRODUCT CUSTOMER DRAWING	
1 PLACE ±		±		INITIAL REVISION:											
0 PLACES ±		±		DRWN: COMERCI		1997/08/21		DOCUMENT NUMBER							
ANGULAR TOL ±		0.5 °		APPR: KPRASAD		2009/02/09		DOC TYPE DOC PART REVISION							
DRAFT WHERE APPLICABLE MUST REMAIN WITHIN DIMENSIONS				THIRD ANGLE PROJECTION		DRAWING		SERIES							
						D-SIZE		43915							
						MATERIAL NUMBER		CUSTOMER							
						SEE CHART		GENERAL MARKET							
								SHEET NUMBER							
								2 OF 2							