



Is Now Part of



ON Semiconductor®

To learn more about ON Semiconductor, please visit our website at
www.onsemi.com

ON Semiconductor and the ON Semiconductor logo are trademarks of Semiconductor Components Industries, LLC dba ON Semiconductor or its subsidiaries in the United States and/or other countries. ON Semiconductor owns the rights to a number of patents, trademarks, copyrights, trade secrets, and other intellectual property. A listing of ON Semiconductor's product/patent coverage may be accessed at www.onsemi.com/site/pdf/Patent-Marking.pdf. ON Semiconductor reserves the right to make changes without further notice to any products herein. ON Semiconductor makes no warranty, representation or guarantee regarding the suitability of its products for any particular purpose, nor does ON Semiconductor assume any liability arising out of the application or use of any product or circuit, and specifically disclaims any and all liability, including without limitation special, consequential or incidental damages. Buyer is responsible for its products and applications using ON Semiconductor products, including compliance with all laws, regulations and safety requirements or standards, regardless of any support or applications information provided by ON Semiconductor. "Typical" parameters which may be provided in ON Semiconductor data sheets and/or specifications can and do vary in different applications and actual performance may vary over time. All operating parameters, including "Typicals" must be validated for each customer application by customer's technical experts. ON Semiconductor does not convey any license under its patent rights nor the rights of others. ON Semiconductor products are not designed, intended, or authorized for use as a critical component in life support systems or any FDA Class 3 medical devices or medical devices with a same or similar classification in a foreign jurisdiction or any devices intended for implantation in the human body. Should Buyer purchase or use ON Semiconductor products for any such unintended or unauthorized application, Buyer shall indemnify and hold ON Semiconductor and its officers, employees, subsidiaries, affiliates, and distributors harmless against all claims, costs, damages, and expenses, and reasonable attorney fees arising out of, directly or indirectly, any claim of personal injury or death associated with such unintended or unauthorized use, even if such claim alleges that ON Semiconductor was negligent regarding the design or manufacture of the part. ON Semiconductor is an Equal Opportunity/Affirmative Action Employer. This literature is subject to all applicable copyright laws and is not for resale in any manner.



FSB127AH

mWSaver™ Fairchild Power Switch (FPS™)

Features

mWSaver™ Technology

- Achieves Low No-Load Power Consumption: < 40 mW at 230 V_{AC} (EMI Filter Loss Included)
- Meets 2013 ErP Standby Power Regulation (< 0.5 W Consumption with 0.25 W Load) for ATX Power and LCD TV Power
- Eliminates X-Cap Discharge Resistor Loss with Ax-CAP® Technology
- Linearly Decreases Switching Frequency at Light-Load Condition and Advanced Burst Mode Operation at No-Load Condition
- 700 V High-Voltage JFET Startup Circuit Eliminates Startup Resistor Loss

Highly Integrated with Rich Features

- Internal Avalanche-Rugged 700 V SenseFET
- Built-in 5 ms Soft-Start
- Peak-Current-Mode Control
- Cycle-by-Cycle Current Limiting
- Leading-Edge Blanking (LEB)
- Synchronized Slope Compensation
- Proprietary Asynchronous Jitter to Reduce EMI

Advanced Protection

- Internal Overload / Open-Loop Protection (OLP)
- V_{DD} Under-Voltage Lockout (UVLO)
- V_{DD} Over-Voltage Protection (OVP)
- Constant Power Limit (Full AC Input Range)
- Internal Auto-Restart Circuit (OLP, V_{DD} OVP, OTP)
- Internal OTP Sensor with Hysteresis
- Adjustable Peak Current Limit

Description

The FSB127AH next-generation, Green-Mode, Fairchild Power Switch (FPS™) incorporates Fairchild's innovative mWSaver™ technology, which dramatically reduces standby and no-load power consumption, enabling conformance to all worldwide Standby Mode efficiency guidelines. It integrates an advanced current-mode Pulse Width Modulator (PWM) and an avalanche-rugged 700 V SenseFET in a single package, allowing auxiliary power designs with higher standby energy efficiency, reduced size, improved reliability, and lower system cost than previous solutions.

Fairchild Semiconductor's mWSaver™ technology offers best-in-class minimum no-load and light-load power consumption. An innovative Ax-CAP® method, one of the five proprietary mWSaver™ technologies, minimizes losses in the EMI filter stage by eliminating the X-Cap discharge resistors while still meeting IEC61010-1 safety requirements. mWSaver™ Green Mode gradually decreases switching frequency as load decreases to minimize switching losses.

A new proprietary asynchronous jitter decreases EMI emission. Built-in synchronized slope compensation allows stable peak-current-mode control over a wide range of input voltage. The proprietary internal line compensation ensures constant-output power limit over the entire universal line voltage range.

Requiring minimum external components, FSB127AH provides a solid platform for cost-effective flyback converter design with low standby power consumption.

Applications

General-purpose switched-mode power supplies (SMPS) and flyback power converters, including:

- Auxiliary Power Supply for PC, Server, LCD TV, and Game Console
- SMPS for VCR, SVR, STB, DVD, and DVCD Player, Printer, Facsimile, and Scanner
- General Adapter
- LCD Monitor Power / Open-Frame SMPS

Ordering Information

Part Number	SenseFET	Operating Temperature Range	Package	Packing Method
FSB127AHN	2 A 700 V	-40°C to +105°C	8-Pin, Dual Inline Package (DIP)	Tube

Pin Configuration

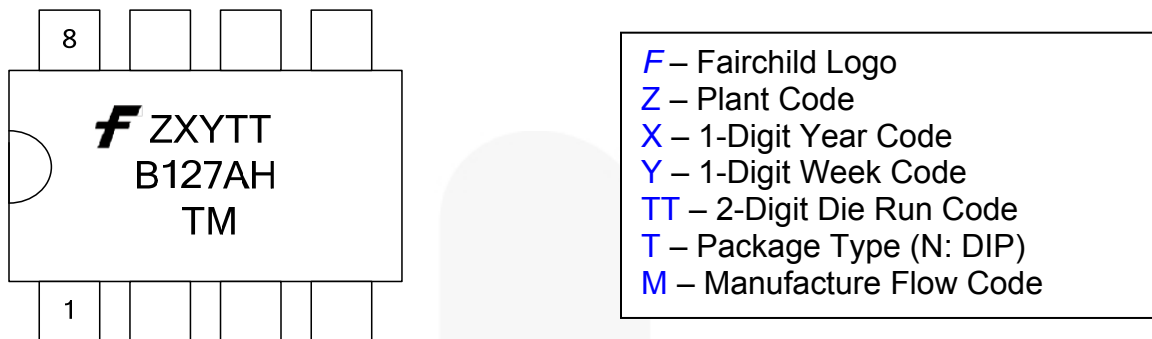

Figure 3. Pin Configuration

Pin Definitions

Pin #	Name	Description
1	GND	Ground. This pin internally connects to the SenseFET source and the signal ground of the PWM controller.
2	VDD	Supply Voltage of the IC. Typically the hold-up capacitor connects from this pin to ground. A rectifier diode in series with the transformer auxiliary winding connects to this pin to supply bias during normal operation.
3	FB	Feedback. The signal from the external compensation circuit connects to this pin. The PWM duty cycle is determined by comparing the signal on this pin and the internal current-sense signal.
4	IPK	Adjust Peak Current. Typically a resistor connects from this pin to the GND pin to program the current-limit level. The internal current source (50 μ A) introduces voltage drop across the resistor, which determines the current-limit level of pulse-by-pulse current limit.
5	HV	Startup. Typically, resistors in series with diodes from the AC line connect to this pin to supply internal bias and to charge the external capacitor connected between the VDD pin and the GND pin during startup. This pin is also used to sense the line voltage for brownout protection and AC line disconnection detection.
6	Drain	SenseFET Drain. This pin is designed to directly drive the transformer.
7		
8		

Absolute Maximum Ratings

Stresses exceeding the absolute maximum ratings may damage the device. The device may not function or be operable above the recommended operating conditions and stressing the parts to these levels is not recommended. In addition, extended exposure to stresses above the recommended operating conditions may affect device reliability. The absolute maximum ratings are stress ratings only.

Symbol	Parameter	Min.	Max.	Unit
V _{DRAIN}	Drain Pin Voltage ^(5,6)		700	V
I _{DM}	Drain Current Pulsed ⁽⁷⁾		8	A
E _{AS}	Single Pulsed Avalanche Energy ⁽⁸⁾		140	mJ
V _{DD}	DC Supply Voltage		30	V
V _{FB}	FB Pin Input Voltage	-0.3	7.0	V
V _{IPK}	IPK Pin Input Voltage	-0.3	7.0	V
V _{HV}	HV Pin Input Voltage		700	V
P _D	Power Dissipation (T _A < 50°C)		1.5	W
T _J	Operating Junction Temperature	-40	Internally Limited ⁽⁹⁾	°C
T _{STG}	Storage Temperature Range	-55	+150	°C
T _L	Lead Soldering Temperature (Wave Soldering or IR, 10 Seconds)		+260	°C
ESD	Electrostatic Discharge Capability, All Pins Except HV Pin	Human Body Model: JESD22-A114	5.50	kV
		Charged Device Model: JESD22-C101	2.00	
	Electrostatic Discharge Capability, All Pins Including HV Pin	Human Body Model: JESD22-A114	3.00	
		Charged Device Model: JESD22-C101	1.25	

Notes:

- All voltage values, except differential voltages, are given with respect to the network ground terminal.
- Stresses beyond those listed under Absolute Maximum Ratings may cause permanent damage to the device.
- Non-repetitive rating; pulse width is limited by the maximum junction temperature.
- L = 51 mH, starting T_J = 25°C.
- Internally limited by Over-Temperature Protection (OTP) (refer to T_{OTP}).

Recommended Operating Conditions

The Recommended Operating Conditions table defines the conditions for actual device operation. Recommended operating conditions are specified to ensure optimal performance to the datasheet specifications. Fairchild does not recommend exceeding them or designing to Absolute Maximum Ratings.

Symbol	Parameter	Min.	Max.	Unit
R _{HV}	Resistor Connect to HV Pin for Full Range Input Detection	150	250	kΩ

Thermal Resistance Table

Symbol	Parameter	Typ.	Unit
θ _{JA}	Junction-to-Air Thermal Resistance	86	°C/W
ψ _{JT}	Junction-to-Package Thermal Resistance ⁽¹⁰⁾	20	°C/W

Note:

- Measured on the package top surface.

Electrical Characteristics

$V_{DD}=15\text{ V}$ and $T_A=25^\circ\text{C}$ unless otherwise specified.

Symbol	Parameter	Condition	Min.	Typ.	Max.	Unit
SenseFET Section⁽¹¹⁾						
BV_{DSS}	Drain-Source Breakdown Voltage	$V_{DS} = 700\text{ V}, V_{GS} = 0\text{ V}$	700			V
I_{DSS}	Zero-Gate-Voltage Drain Current	$V_{DS} = 700\text{ V}, V_{GS} = 0\text{ V}$			50	μA
		$V_{DS} = 560\text{ V}, V_{GS} = 0\text{ V}, T_C = 125^\circ\text{C}$			200	
$R_{DS(ON)}$	Drain-Source On-State Resistance ⁽¹¹⁾	$V_{GS} = 10\text{ V}, I_D = 0.5\text{ A}$		6.0	7.2	Ω
C_{ISS}	Input Capacitance	$V_{GS} = 0\text{ V}, V_{DS} = 25\text{ V}, f = 1\text{ MHz}$		550	715	pF
C_{OSS}	Output Capacitance	$V_{GS} = 0\text{ V}, V_{DS} = 25\text{ V}, f = 1\text{ MHz}$		38	50	pF
C_{RSS}	Reverse Transfer Capacitance	$V_{GS} = 0\text{ V}, V_{DS} = 25\text{ V}, f = 1\text{ MHz}$		17	26	pF
$t_{d(on)}$	Turn-On Delay	$V_{DS} = 350\text{ V}, I_D = 1.0\text{ A}$		20	50	ns
t_r	Rise Time	$V_{DS} = 350\text{ V}, I_D = 1.0\text{ A}$		15	40	ns
$t_{d(off)}$	Turn-Off Delay	$V_{DS} = 350\text{ V}, I_D = 1.0\text{ A}$		55	120	ns
t_f	Fall Time	$V_{DS} = 350\text{ V}, I_D = 1.0\text{ A}$		25	60	ns
Control Section						
V_{DD} Section						
V_{DD-ON}	UVLO Start Threshold Voltage		11	12	13	V
$V_{DD-OFF1}$	UVLO Stop Threshold Voltage		5	6	7	V
$V_{DD-OFF2}$	I_{DD-OLP} Enable Threshold Voltage		8	9	10	V
V_{DD-OLP}	V_{DD} Voltage Threshold for HV Startup Turn-On at Protection Mode		5	6	7	V
I_{DD-ST}	Startup Supply Current	$V_{DD-ON} - 0.16\text{ V}$			30	μA
I_{DD-OP1}	Operating Supply Current with Normal Switching Operation	$V_{DD}=15\text{ V}, V_{FB}=3\text{ V}$			3.8	mA
I_{DD-OP2}	Operating Supply Current without Switching Operation	$V_{DD}=15\text{ V}, V_{FB}=1\text{ V}$			1.8	mA
I_{DD-OLP}	Internal Sinking Current	$V_{DD-OLP} + 0.1\text{ V}$	30	60	90	μA
V_{DD-OVP}	V_{DD} Over-Voltage Protection		27	28	29	V
$t_{D-VDDOVP}$	V_{DD} Over-Voltage Protection Debounce Time		70	140	210	μs
HV Section						
I_{HV}	Supply Current Drawn from HV Pin	$HV=120\text{ V}_{DC}, V_{DD}=0\text{ V}$ with $10\text{ }\mu\text{F}$	1.5		5.0	mA
I_{HV-LC}	Leakage Current after Startup	$HV=700\text{ V}, V_{DD}=V_{DD-OFF1}+1\text{ V}$			10	μA
V_{AC-ON}	Brown-in Threshold Level (V_{DC})	DC Voltage Applied to HV Pin Through $200\text{ k}\Omega$ Resistor	110	114	118	V
V_{AC-OFF}	Brownout Threshold Level (V_{DC})		93	99	105	V
t_{UVP}	Brownout Protection Time		0.8	1.2	1.6	s

Continued on the following page...

Electrical Characteristics (Continued)

 $V_{DD}=15\text{ V}$ and $T_A=25^\circ\text{C}$ unless otherwise specified.

Symbol	Parameter	Condition	Min.	Typ.	Max.	Unit
Oscillator Section						
f_{OSC}	Frequency in Nominal Mode	Center Frequency	94	100	106	kHz
		Hopping Range	± 4	± 6	± 8	
t_{HOP}	Hopping Period ⁽¹¹⁾			20		ms
f_{OSC-G}	Green-Mode Frequency		20	23	26	kHz
f_{DV}	Frequency Variation vs. V_{DD} Deviation	$V_{DD}=11\text{ V to }22\text{ V}$			5	%
f_{DT}	Frequency Variation vs. Temperature Deviation ⁽¹¹⁾	$T_A=-40\text{ to }105^\circ\text{C}$			5	%
Feedback Input Section						
A_V	Internal Voltage Dividing Factor of FB Pin ⁽¹¹⁾		1/4.5	1/4.0	1/3.5	V/V
Z_{FB}	Pull-Up Impedance of FB Pin		15	21	27	k Ω
$V_{FB-OPEN}$	FB Pin Pull-Up Voltage	FB Pin Open	5.2	5.4	5.6	V
V_{FB-OLP}	FB Voltage Threshold to Trigger Open-Loop Protection		4.3	4.6	4.9	V
t_{D-OLP}	Delay of FB Pin Open-Loop Protection		46	56	66	ms
V_{FB-N}	FB Voltage Threshold to Exit Green Mode	V_{FB} is Rising	2.4	2.6	2.8	V
V_{FB-G}	FB Voltage Threshold to Enter Green Mode	V_{FB} is Falling		$V_{FB-N}-0.2$		V
V_{FB-ZDC}	FB Voltage Threshold to Enter Zero-Duty State	V_{FB} is Falling	1.95	2.05	2.15	V
$V_{FB-ZDCR}$	FB Voltage Threshold to Exit Zero-Duty State	V_{FB} is Rising		$V_{FB-ZDC}+0.1$		V
IPK Pin Section						
$V_{IPK-OPEN}$	IPK Pin Open Voltage		3.0	3.5	4.0	V
V_{IPK-H}	Internal Upper Clamping Voltage of IPK Pin ⁽¹¹⁾				3	V
V_{IPK-L}	Internal Lower Clamping Voltage of IPK Pin ⁽¹¹⁾		1.5			V
I_{PK}	Internal Current Source of IPK Pin	$T_A=-40\text{ to }105^\circ\text{C}$, $V_{IPK}=2.25\text{ V}$	45	50	55	μA
$I_{LMT-FL-H}$	Flat Threshold Level of Current Limit for the Highest IPK Level	$V_{IPK}=3\text{ V}$, Duty>40%	0.90	1.00	1.10	A
$I_{LMT-VA-H}$	Valley Threshold Level of Current Limit for the Highest IPK Level ⁽¹¹⁾	$V_{IPK}=3\text{ V}$, Duty=0%		$I_{LMT-FL-H}-0.25$		A
$I_{LMT-FL-L}$	Flat Threshold Level of Current Limit for the Lowest IPK Level	$V_{IPK}=1.5\text{ V}$, Duty>40%	0.45	0.50	0.55	A
$I_{LMT-VA-L}$	Valley Threshold Level of Current Limit for the Lowest IPK Level ⁽¹¹⁾	$V_{IPK}=1.5\text{ V}$, Duty=0%		$I_{LMT-FL-L}-0.12$		A

Continued on the following page...

Electrical Characteristics (Continued)

$V_{DD}=15\text{ V}$, $T_A=25^\circ\text{C}$ unless otherwise specified.

Symbol	Parameter	Condition	Min.	Typ.	Max.	Unit
Current-Sense Section⁽¹²⁾						
t_{PD}	Current Limit Turn-Off Delay			100	200	ns
t_{LEB}	Leading-Edge Blanking Time		230	280	330	ns
t_{SS}	Soft-Start Time ⁽¹¹⁾			5		ms
GATE Section⁽¹²⁾						
DCY_{MAX}	Maximum Duty Cycle		70			%
Over-Temperature Protection Section (OTP)						
T_{OTP}	Junction Temperature to trigger OTP ⁽¹¹⁾		135	142	150	°C
ΔT_{OTP}	Hysteresis of OTP ⁽¹¹⁾			25		°C

Notes:

- 11. Guaranteed by design; not 100% tested in production.
- 12. Pulse test: pulse width $\leq 300\ \mu\text{s}$, duty $\leq 2\%$.
- 13. These parameters, although guaranteed, are tested in wafer-sort process.

Typical Characteristics

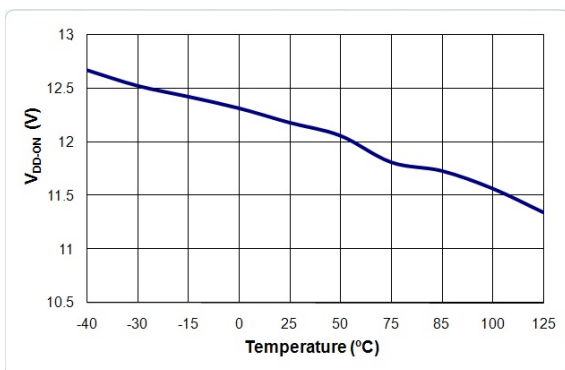

Figure 4. V_{DD-ON} vs. Temperature

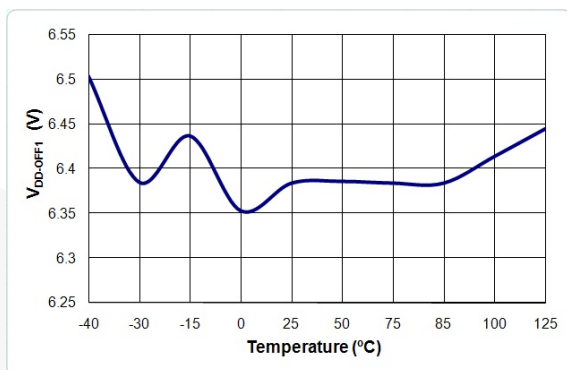

Figure 5. V_{DD-OFF1} vs. Temperature

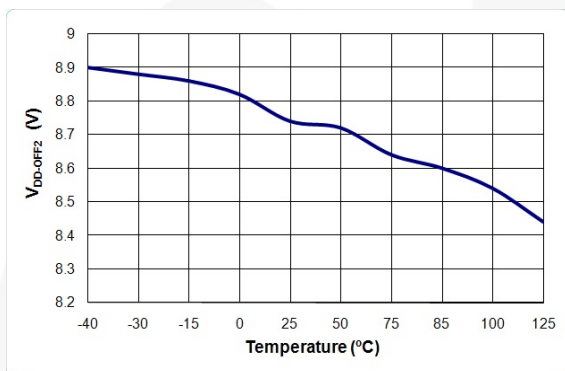

Figure 6. V_{DD-OFF2} vs. Temperature

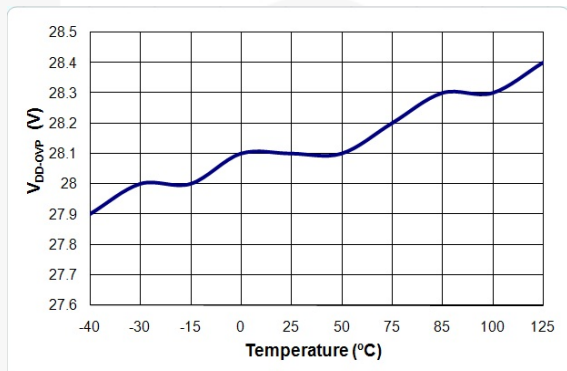

Figure 7. V_{DD-OVP} vs. Temperature

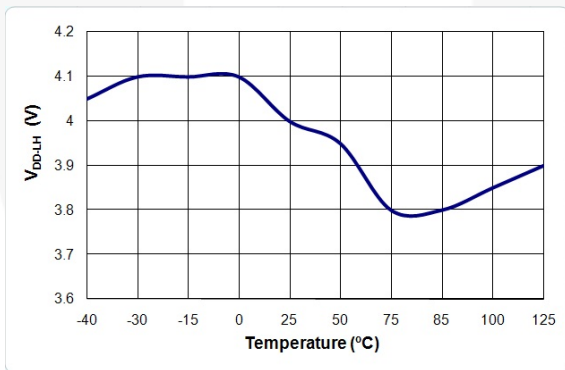

Figure 8. V_{DD-LH} vs. Temperature

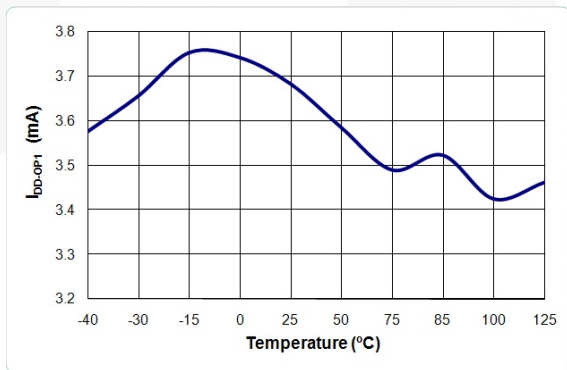

Figure 9. I_{DD-OP1} vs. Temperature

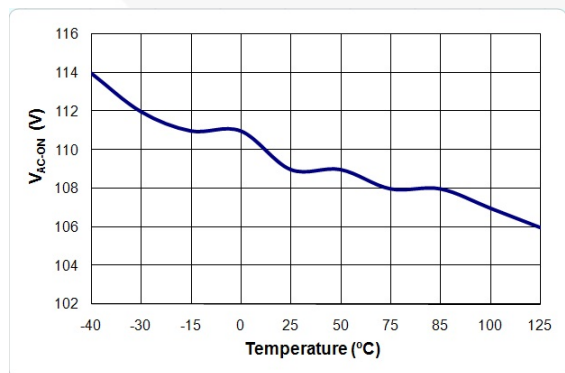

Figure 10. V_{AC-ON} vs. Temperature

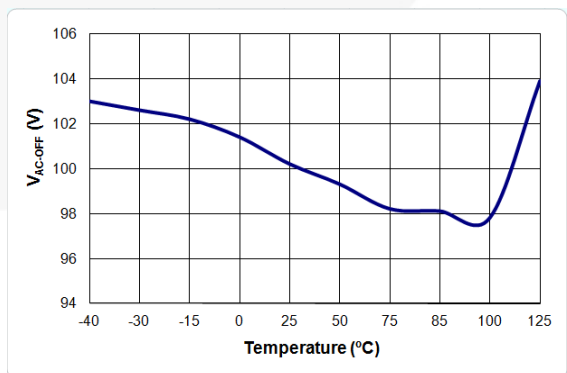

Figure 11. V_{AC-OFF} vs. Temperature

Typical Characteristics

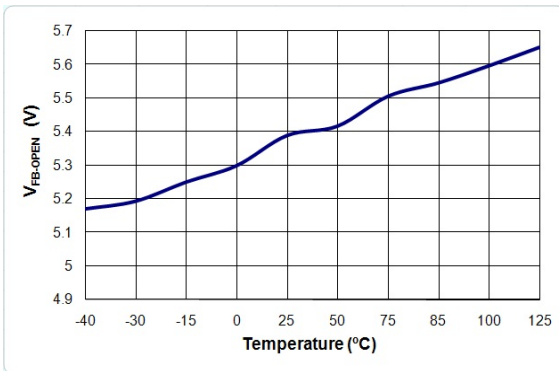

Figure 12. V_{FB-OPEN} vs. Temperature

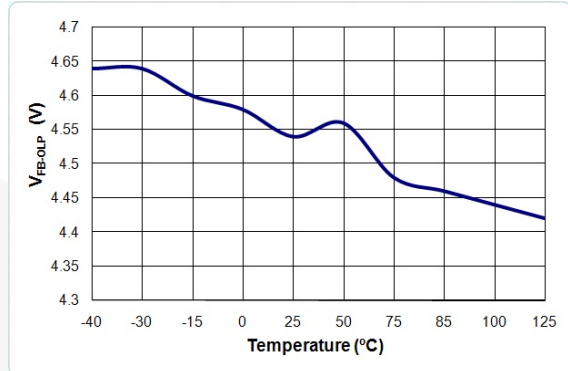

Figure 13. V_{FB-OLP} vs. Temperature

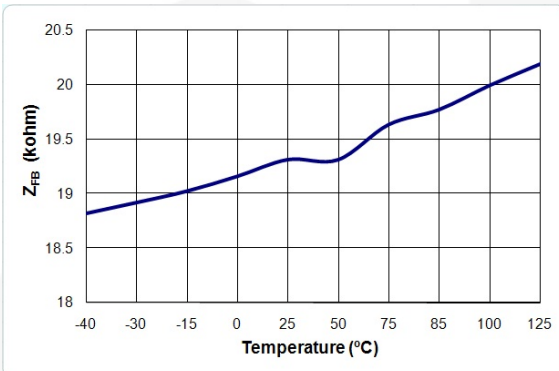

Figure 14. Z_{FB} vs. Temperature

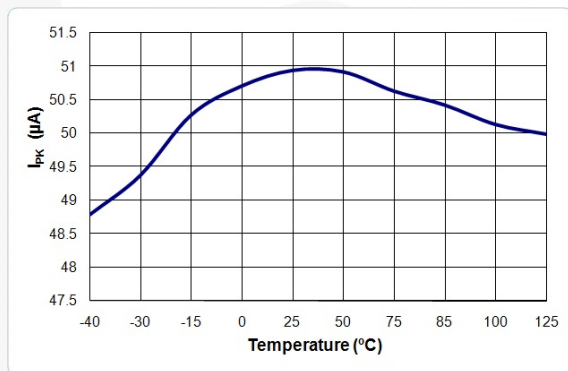

Figure 15. I_{PK} vs. Temperature

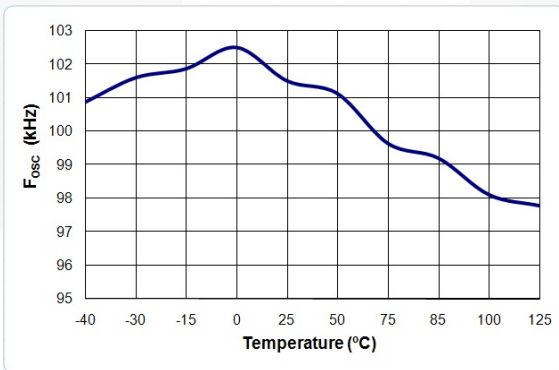

Figure 16. f_{osc} vs. Temperature

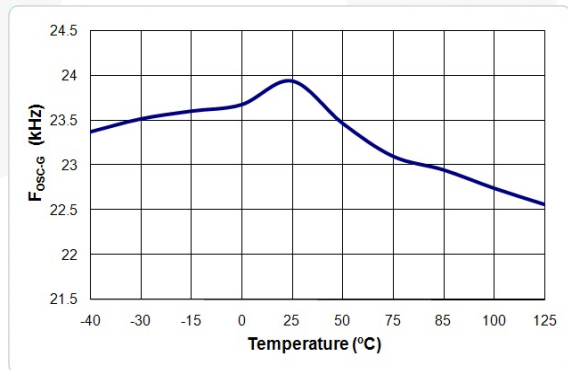

Figure 17. f_{osc-G} vs. Temperature

Functional Description

Startup Operation

The HV pin is typically connected to the AC line input through two external diodes and one resistor (R_{HV}), as shown in Figure 18. When the AC line voltage is applied, the V_{DD} hold-up capacitor is charged by the line voltage through the diodes and resistor. After V_{DD} voltage reaches the turn-on threshold voltage (V_{DD-ON}), the startup circuit charging the V_{DD} capacitor is switched off and V_{DD} is supplied by the auxiliary winding of the transformer. Once the FSB127AH starts, it continues operation until V_{DD} drops below 6 V ($V_{DD-OFF1}$). The IC startup time with a given AC line input voltage is:

$$t_{STARTUP} = R_{HV} \cdot C_{DD} \cdot \ln \frac{V_{AC-IN} \cdot \frac{2\sqrt{2}}{\pi}}{V_{AC-IN} \cdot \frac{2\sqrt{2}}{\pi} - V_{DD-ON}} \quad (1)$$

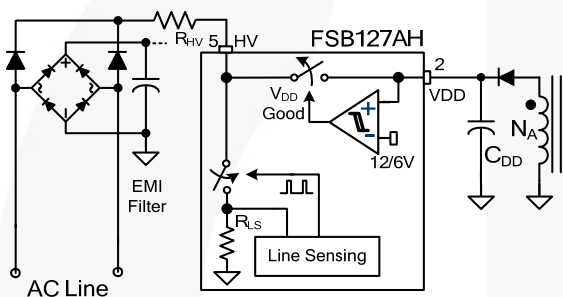

Figure 18. Startup Circuit

Brown-in/out Function

The HV pin can detect the AC line voltage using a switched voltage divider that consists of external resistor (R_{HV}) and internal resistor (R_{LS}), as shown in Figure 18. The internal line-sensing circuit detects the real RMS value of the line voltage using a sampling circuit and peak-detection circuit. Because the voltage divider causes power consumption when it is switched on, the switching is driven by a signal with a very narrow pulse width to minimize power loss. The sampling frequency is adaptively changed according to the load condition to minimize power consumption in light-load condition.

Based on the detected line voltage, brown-in and brownout thresholds are determined. Since the internal resistor (R_{LS}) of the voltage divider is much smaller than R_{HV} , the thresholds are given as:

$$V_{BROWN-IN}(RMS) = \frac{R_{HV}}{200k} \cdot \frac{V_{AC-ON}}{\sqrt{2}} \quad (2)$$

$$V_{BROWN-OUT}(RMS) = \frac{R_{HV}}{200k} \cdot \frac{V_{AC-OFF}}{\sqrt{2}} \quad (3)$$

PWM Control

The FSB127AH employs current-mode control, as shown in Figure 19. An opto-coupler (such as the H11A817A) and shunt regulator (such as the KA431) are typically used to implement the feedback network. Comparing the feedback voltage with the voltage across the R_{SENSE} resistor makes it possible to control the switching duty cycle. A synchronized positive slope is added to the SenseFET current information to guarantee stable current-mode control over a wide range of input voltage. The built-in slope compensation stabilizes the current loop and prevents sub-harmonic oscillation.

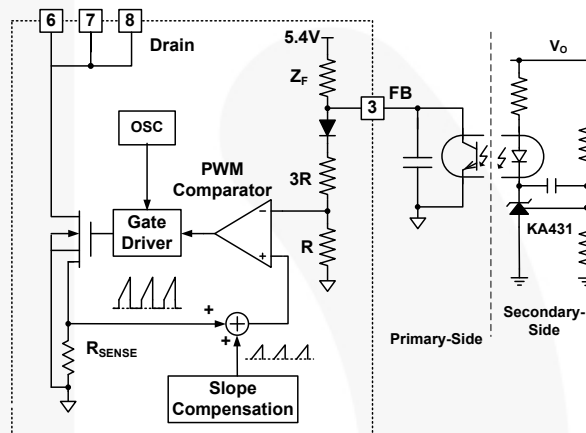

Figure 19. Current Mode Control

Soft-Start

The internal soft-start circuit progressively increases the pulse-by-pulse current limit level of MOSFET during startup to establish the correct working conditions for transformers and capacitors, as shown in Figure 20. The current limit levels have nine steps, as shown in Figure 21. This prevents transformer saturation and reduces stress on the secondary diode during startup.

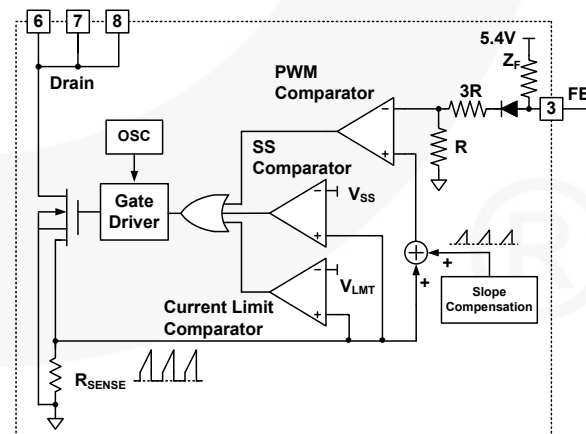

Figure 20. Soft-Start and Current-Limit Circuit

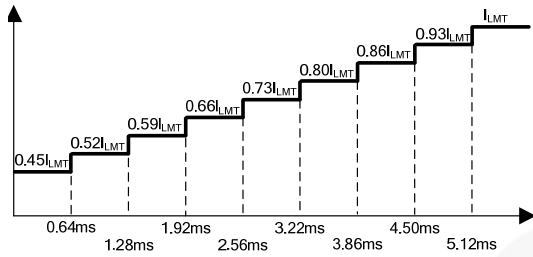

Figure 21. Current Limit Variation During Soft-Start

Adjustable Peak Current Limit & H/L Line Compensation for Constant Power Limit

To make the limited output power constant, regardless of the line voltage condition, a special current-limit profile with sample and hold is used (as shown in Figure 22). The current-limit level is sampled and held at the falling edge of the gate drive signal, as shown in Figure 23. Then, the sampled current-limit level is used for the next switching cycle. The sample-and-hold prevents sub-harmonic oscillation in current-mode control.

The current-limit level increases as the duty cycle increases, which reduces the current limit as duty cycle decreases. This allows a lower current-limit level for high-line voltage condition where the duty cycle is smaller than that of low line. Therefore, the limited maximum output power can remain constant even for a wide input voltage range.

The peak current limit is programmable using a resistor on the IPK pin. The internal 50 μ A current source for the IPK pin generates voltage drop across the resistor. The voltage of the IPK pin determines the current-limit level. Since the upper and lower clamping voltages of the IPK pin are 3 V and 1.5 V, respectively; the suggested resistor value is from 30 k Ω to 60 k Ω .

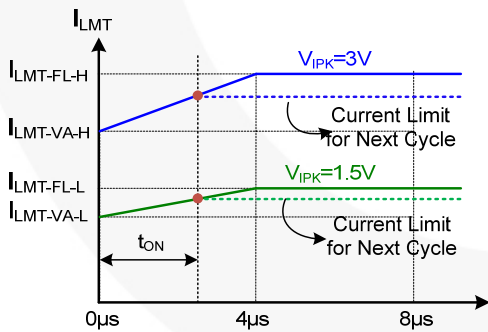

Figure 22. I_{LMT} vs. PWM Turn-On Time

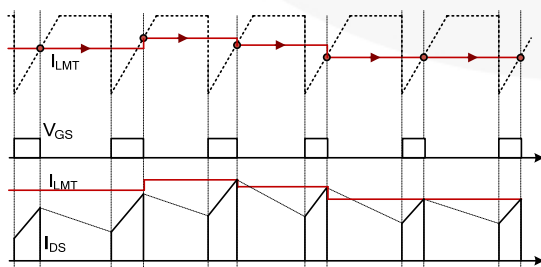

Figure 23. Current Limit Variation with Duty Cycle

mWSaver™ Technology

Ax-CAP® Elimination of X-Cap Discharge Resistors

The EMI filter in the front end of the switched-mode power supply (SMPS) typically includes a capacitor across the AC line connector, as shown in Figure 24. Most of the safety regulations, such as UL 1950 and IEC61010-1, require the capacitor be discharged to a safe level within a given time after being unplugged from the power outlet. Typically a discharge resistor across the capacitor is used to ensure the capacitor is discharged naturally, which introduces power loss. As power level increases, the EMI filter capacitor tends to increase, requiring a smaller discharge resistor to maintain the same discharge time. This typically results in more power dissipation in high-power applications. The innovative Ax-CAP technology intelligently discharges the filter capacitor only when the power supply is unplugged from the power outlet. Since the Ax-CAP® discharge circuit is disabled in normal operation, the power loss in the EMI filter can be virtually removed.

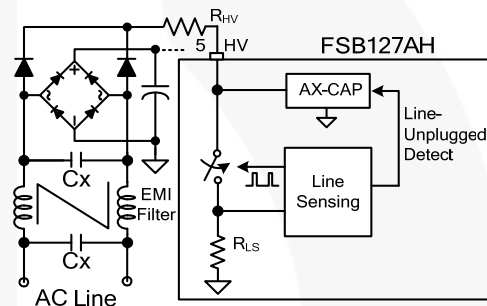

Figure 24. Ax-CAP® Circuit

Green Mode

The FSB127AH modulates the PWM frequency as a function of FB voltage, as shown in Figure 25. Since the output power is proportional to the FB voltage in current-mode control, the switching frequency decreases as load decreases. In heavy-load conditions, the switching frequency is 100 kHz. Once V_{FB} decreases below V_{FB-N} (2.6 V), the PWM frequency linearly decreases from 100 kHz to 23 kHz to reduce switching losses at light-load condition. As V_{FB} decreases to V_{FB-G} (2.4 V), the switching frequency is fixed at 23 kHz.

As V_{FB} falls below V_{FB-ZDC} (2.1 V), the FSB127AH enters Burst Mode, where PWM switching is disabled. Then the output voltage starts to drop, causing the feedback voltage to rise. Once V_{FB} rises above $V_{FB-ZDCR}$, switching resumes. Burst Mode alternately enables and disables switching, thereby reducing switching loss to reduce power consumption, as shown in Figure 26.

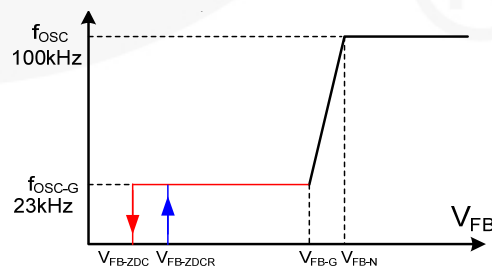

Figure 25. PWM Frequency

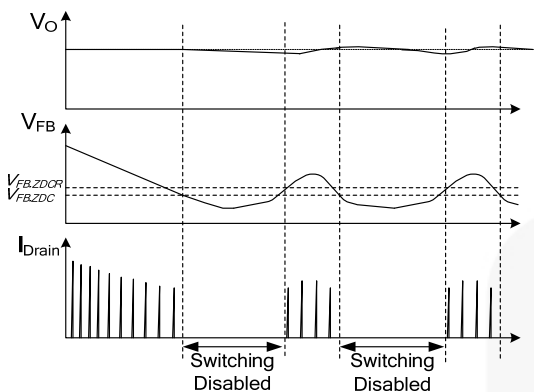

Figure 26. Burst-Mode Operation

Protections

Protection functions include Overload / Open-Loop Protection (OLP), Over-Voltage Protection (OVP), and Over-Temperature Protection (OTP). All the protections are implemented as Auto-Restart Mode. Once the fault condition is detected, switching is terminated and the SenseFET remains off. This causes V_{DD} to fall. When V_{DD} falls to 6 V, the protection is reset and HV startup circuit charges V_{DD} up to 12 V voltage, allowing restart.

Open-Loop / Overload Protection (OLP)

Because of the pulse-by-pulse current-limit capability, the maximum peak current through the SenseFET is limited and maximum input power is limited. If the output consumes more than the limited maximum power, the output voltage (V_o) drops below the set voltage. Then the current through the opto-coupler LED and the transistor become virtually zero and FB voltage is pulled HIGH, as shown in Figure 27. If feedback voltage is above 4.6 V for longer than 56 ms, OLP is triggered. This protection is also triggered when the feedback loop is open due to a soldering defect.

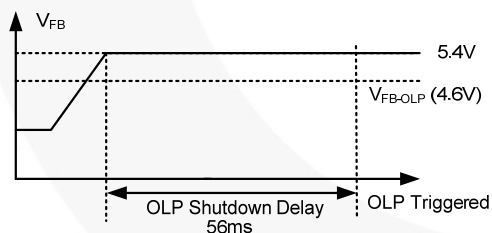

Figure 27. OLP Operation

V_{DD} Over-Voltage Protection (OVP)

If the secondary-side feedback circuit malfunctions or a solder defect causes an opening in the feedback path, the current through the opto-coupler transistor becomes virtually zero. Then feedback voltage climbs up in a similar manner to the overload situation, forcing the preset maximum current to be supplied to the SMPS until the overload protection triggers. Because more energy than required is provided to the output, the output voltage may exceed the rated voltage before the overload protection triggers, resulting in the breakdown of the devices in the secondary side. To prevent this situation, an OVP circuit is employed. Since V_{DD} voltage is proportional to the output voltage by the transformer

coupling, the over voltage of output is indirectly detected using V_{DD} voltage. The OVP is triggered when V_{DD} voltage reaches 28 V. Debounce time (typically 150 μ s) is applied to prevent false triggering by switching noise.

Over-Temperature Protection (OTP)

The SenseFET and the control IC are integrated in one package. This makes it easier for the control IC to detect the abnormal over temperature of the SenseFET. If the temperature exceeds approximately 140°C, the OTP is triggered and the MOSFET remains off. When the junction temperature drops by 25°C from OTP temperature, normal operation resumes.

Two-Level UVLO

Since all the protections are auto-restart, the power supply repeats shutdown and restart until the fault condition is removed. Two-level UVLO is enabled when protection is triggered to delay the re-startup by slowing down V_{DD} discharge. This effectively reduces the input power of the power supply during the fault condition, minimizing the voltage/current stress of the switching devices. Figure 28 shows the normal UVLO operation and two-step UVLO operation. When V_{DD} drops to 6 V without triggering the protection, the PWM stops switching and V_{DD} is charged by the HV startup circuit. Meanwhile, when the protection is triggered, the FSB127AH has a different V_{DD} discharge profile. Once the protection is triggered, the IC stops switching and V_{DD} drops. When V_{DD} drops to 9 V, the operating current becomes very small and V_{DD} is slowly discharged. When V_{DD} is naturally discharged down to 6 V, the protection is reset and V_{DD} is charged by the HV startup circuit. Once V_{DD} reaches 12 V, the IC resumes switching operation.

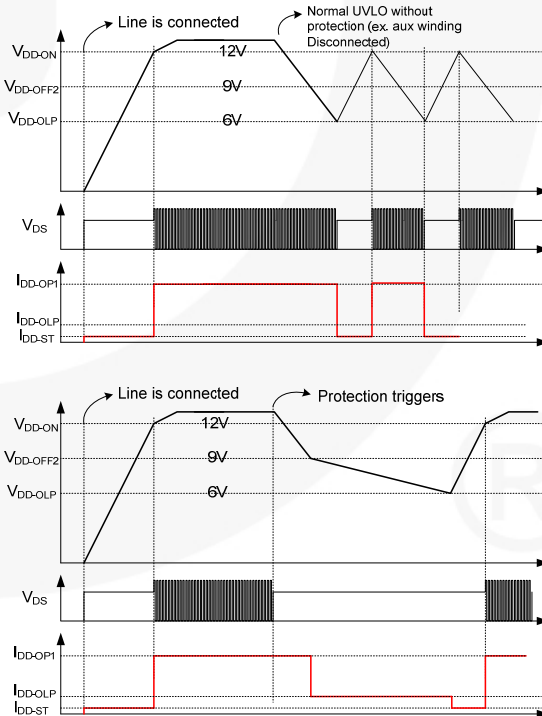

Figure 28. Normal and Two-Level UVLO

Typical Application Circuit

Application	Fairchild Device	Input Voltage Range	Output
Standby Auxiliary Power	FSB127AH	85 V _{AC} ~ 265 V _{AC}	5 V / 3.2 A

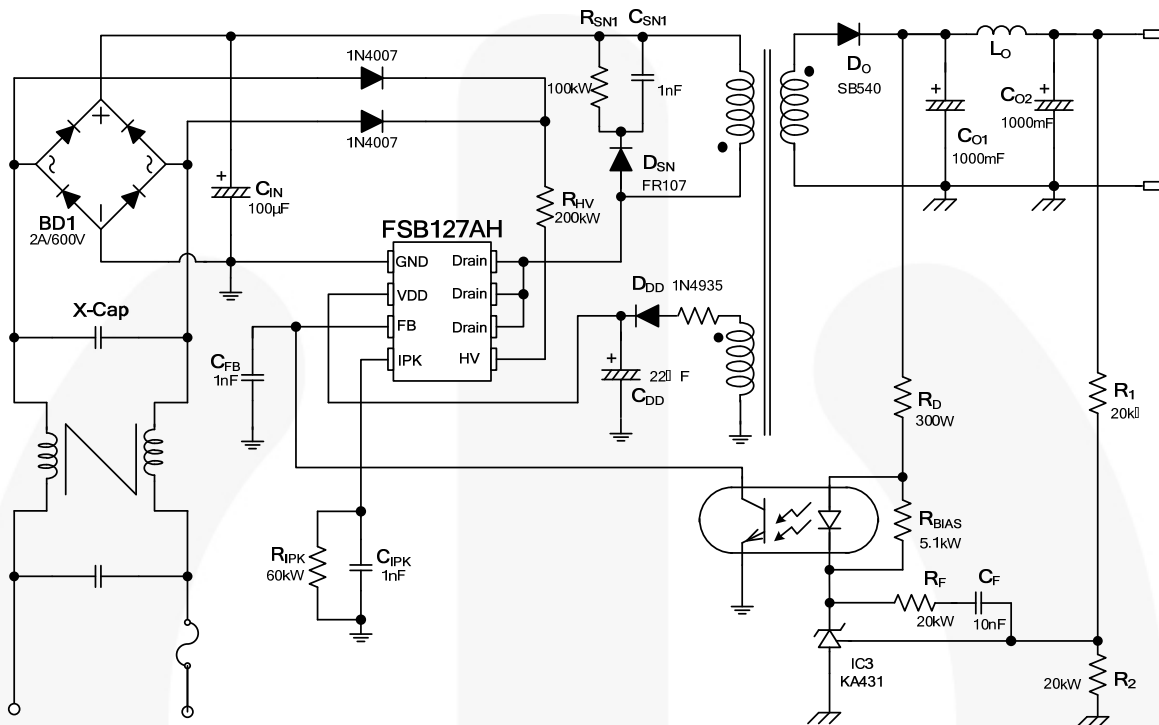

Figure 29. Schematic of Typical Application Circuit

Transformer Specification

- Core: EI 22
- Bobbin: EI 22

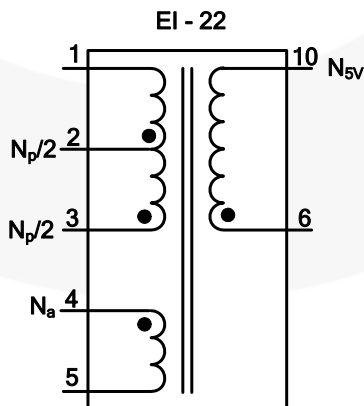

Figure 30. Transformer Specification

Typical Application Circuit (Continued)

	Pin (S → F)	Wire	Turns	Winding Method
N_a	4 → 5	0.15φ×1	12	Solenoid Winding
Insulation: Polyester Tape t = 0.025 mm, 1-Layer				
$N_{p/2}$	3 → 2	0.27φ×1	31	Solenoid Winding
Insulation: Polyester Tape t = 0.025 mm, 2-Layer				
N_{5V}	6 → 10	0.55φ×2	5	Solenoid Winding
Insulation: Polyester Tape t = 0.025 mm, 2-Layer				
$N_{p/2}$	2 → 1	0.27φ×1	31	Solenoid Winding
Insulation: Polyester Tape t = 0.025 mm, 2-Layer				

	Pin	Specification	Remark
Primary-Side Inductance	1 – 3	900 μH ±10%	100 kHz, 1 V
Primary-Side Effective Leakage	1 – 3	< 30 μH Maximum	Short All Other Pins

ON Semiconductor and  are trademarks of Semiconductor Components Industries, LLC dba ON Semiconductor or its subsidiaries in the United States and/or other countries. ON Semiconductor owns the rights to a number of patents, trademarks, copyrights, trade secrets, and other intellectual property. A listing of ON Semiconductor's product/patent coverage may be accessed at www.onsemi.com/site/pdf/Patent-Marking.pdf. ON Semiconductor reserves the right to make changes without further notice to any products herein. ON Semiconductor makes no warranty, representation or guarantee regarding the suitability of its products for any particular purpose, nor does ON Semiconductor assume any liability arising out of the application or use of any product or circuit, and specifically disclaims any and all liability, including without limitation special, consequential or incidental damages. Buyer is responsible for its products and applications using ON Semiconductor products, including compliance with all laws, regulations and safety requirements or standards, regardless of any support or applications information provided by ON Semiconductor. "Typical" parameters which may be provided in ON Semiconductor data sheets and/or specifications can and do vary in different applications and actual performance may vary over time. All operating parameters, including "Typicals" must be validated for each customer application by customer's technical experts. ON Semiconductor does not convey any license under its patent rights nor the rights of others. ON Semiconductor products are not designed, intended, or authorized for use as a critical component in life support systems or any FDA Class 3 medical devices or medical devices with a same or similar classification in a foreign jurisdiction or any devices intended for implantation in the human body. Should Buyer purchase or use ON Semiconductor products for any such unintended or unauthorized application, Buyer shall indemnify and hold ON Semiconductor and its officers, employees, subsidiaries, affiliates, and distributors harmless against all claims, costs, damages, and expenses, and reasonable attorney fees arising out of, directly or indirectly, any claim of personal injury or death associated with such unintended or unauthorized use, even if such claim alleges that ON Semiconductor was negligent regarding the design or manufacture of the part. ON Semiconductor is an Equal Opportunity/Affirmative Action Employer. This literature is subject to all applicable copyright laws and is not for resale in any manner.

PUBLICATION ORDERING INFORMATION

LITERATURE FULFILLMENT:

Literature Distribution Center for ON Semiconductor
19521 E. 32nd Pkwy, Aurora, Colorado 80011 USA
Phone: 303-675-2175 or 800-344-3860 Toll Free USA/Canada
Fax: 303-675-2176 or 800-344-3867 Toll Free USA/Canada
Email: orderlit@onsemi.com

N. American Technical Support: 800-282-9855 Toll Free
USA/Canada
Europe, Middle East and Africa Technical Support:
Phone: 421 33 790 2910
Japan Customer Focus Center
Phone: 81-3-5817-1050

ON Semiconductor Website: www.onsemi.com
Order Literature: <http://www.onsemi.com/orderlit>
For additional information, please contact your local
Sales Representative