

1 2 3 4 5 6

A

B

C

D

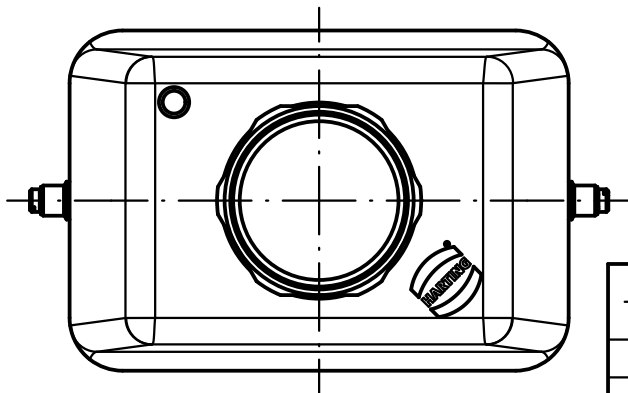
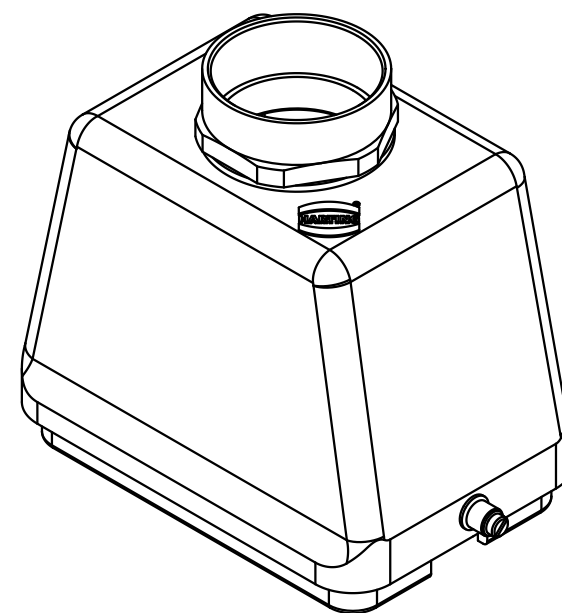
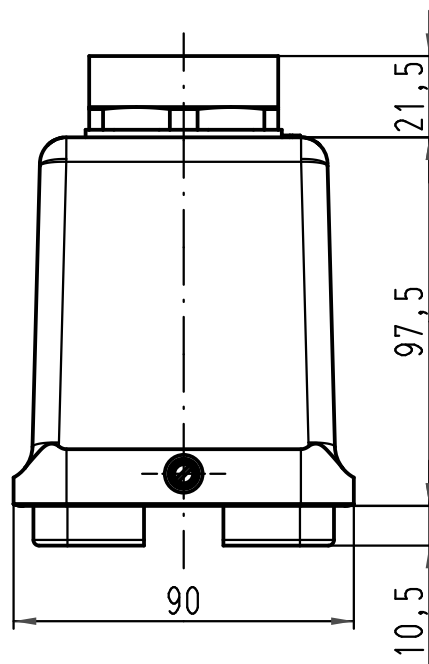
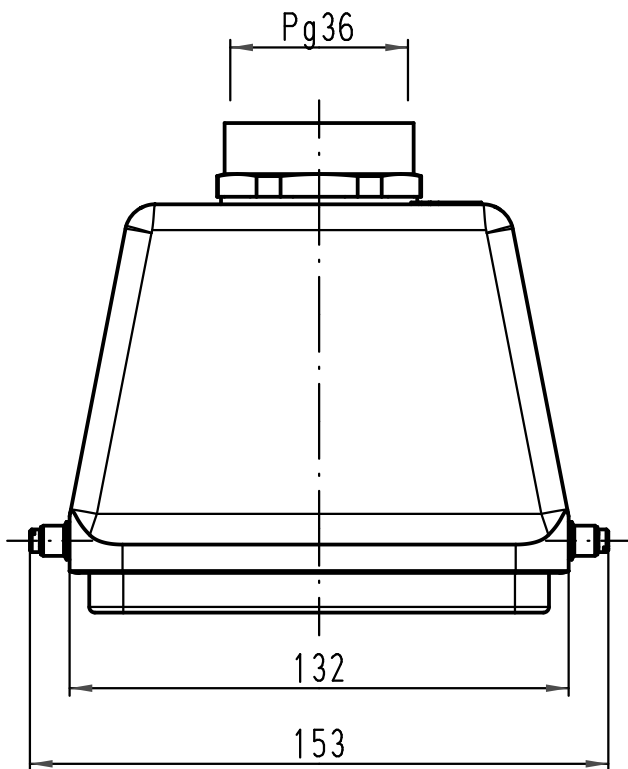

ALL Dimensions in mm Original Size DIN A 4		Techn. Character.			Nicht tolerierte Maße/Free size tolerances	
			Dat.	Name	Maßstab/Scale 1:2	Han 48B-gg-R-36 Gehäuse hood
		Detail.	23.01.09	Bor		
		Insp.		Be		
		Stand.				
A		HARTING Electric GmbH & Co. KG				TB 09 30 048 0441
Mod.	Dat.	Name	D-32339 Espelkamp			
					Sub. TB 09 30 048 0441 v. 07.12.99	
						Blatt/page