

TRIPLE LDO

NO. EA-099-140530

OUTLINE

The R5324x Series are CMOS-based multi positive voltage regulator ICs with high output voltage accuracy, low supply current, low noise, low dropout and high ripple rejection. The R5324x Series contain three voltage regulators. Each of these voltage regulators in the R5324x Series consists of a voltage reference unit, an error amplifier, resistors for setting output voltage, a short current limit circuit, a chip enable circuit, and so on.

The chip enable function contributes to prolong battery life. Further, regulators in the R5324x Series are with low dropout voltage, excellent load transient response and line transient response, thus the R5324x series are very suitable for the power supply for hand-held communication equipment.

Since the packages for these ICs are SON-8 and DFN(PL)2527-10, high density mounting of the ICs on boards is possible.

FEATURES

- Supply Current Typ. 90 μ A (VR1, VR2, VR3)
- Standby Current Typ. 0.1 μ A
- Output Current Min. 200mA (VR1), 150mA (VR2), 100mA (VR3)
- Dropout Voltage Typ. 0.23V (VR1) ($I_{OUT}=200mA$, $V_{OUT}=2.8V$)
Typ. 0.22V (VR2) ($I_{OUT}=150mA$, $V_{OUT}=2.8V$)
Typ. 0.15V (VR3) ($I_{OUT}=100mA$, $V_{OUT}=2.8V$)
- Ripple Rejection Typ. 70dB (f=1kHz), Typ. 65dB (f=10kHz)
- Input Voltage Range 2.0V to 6.0V
- Output Voltage Range 1.5V to 4.0V (0.1V steps)
(For details, please refer to MARK INFORMATION.S.)
- Output Voltage Accuracy $\pm 2.0\%$
- Temperature-Drift Coefficient of Output Voltage Typ. $\pm 100ppm/^{\circ}C$
- Line Regulation Typ. 0.02%/V
- Packages DFN(PL)2527-10, SON-8
- Built-in fold-back protection circuit Typ. 50mA (VR1), Typ. 40mA (VR2, VR3)
(Current at short mode)
- Ceramic capacitors are recommended to be used with this IC 1.0 μ F or more

APPLICATIONS

- Power source for cellular phones and portable communication equipment.
- Power source for electrical appliances such as cameras, VCRs.
- Power source for battery-powered equipment.

* R5324D (SON-8) is the discontinued product. As of March in 2015.

R5324x

BLOCK DIAGRAMS

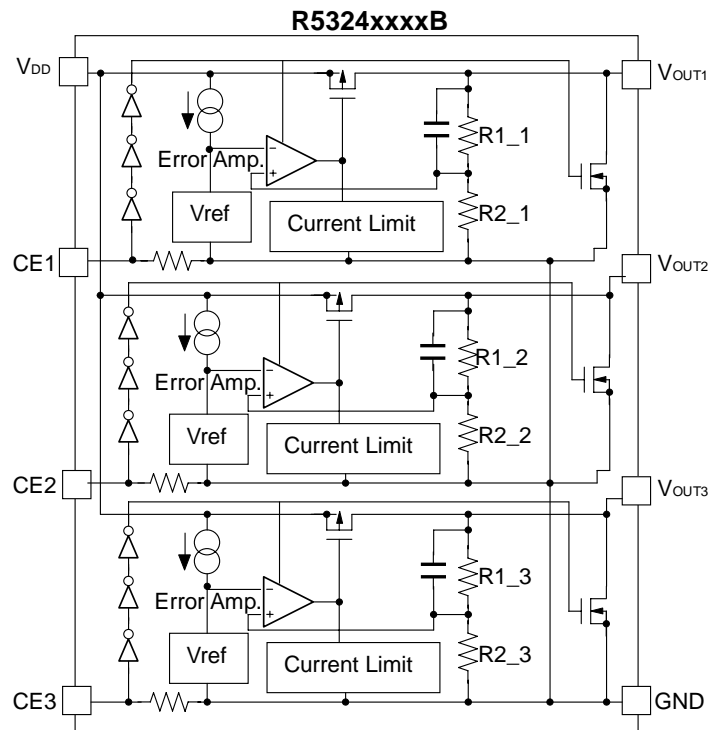
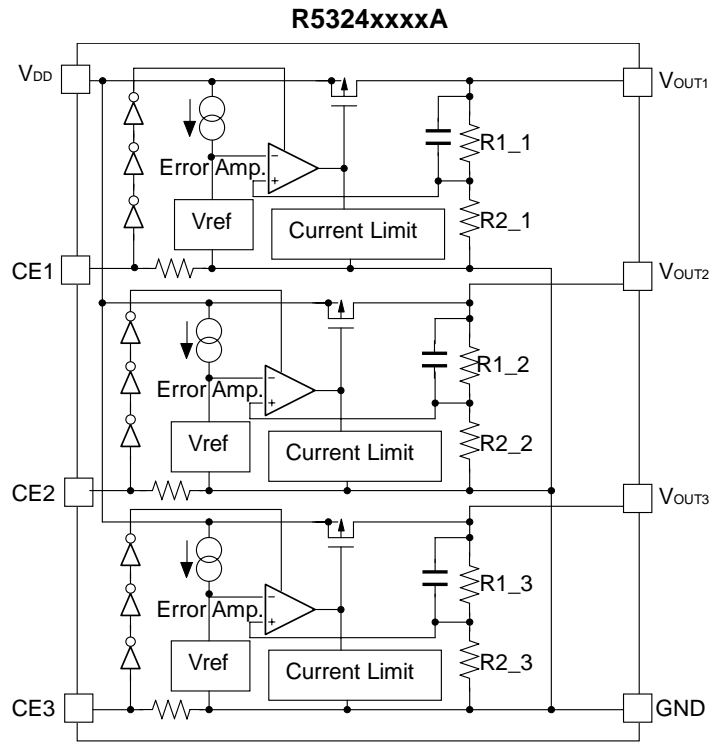

* R5324D (SON-8) is the discontinued product. As of March in 2015.

R5324x

SELECTION GUIDE

The output voltage, auto discharge function, package, etc. for the ICs can be selected at the user's request.

Product Name	Package	Quantity per Reel	Pb Free	Halogen Free
R5324Kxxx*-TR	DFN(PL)2527-10	5,000 pcs	Yes	Yes
R5324Dxxx*-TR-F	SON-8	3,000 pcs	Yes	No

xxx : The combination of output voltage for each channel can be designated by serial numbers. (from 001)
The output voltage for each channel can be set in the range from 1.5V to 4.0V in 0.1V steps.
(For details, please refer to MARK INFORMATIONS.)

* : The auto discharge function at off state are options as follows.
(A) without auto discharge function at off state
(B) with auto discharge function at off state

* R5324D (SON-8) is the discontinued product. As of March in 2015.

R5324x

PIN CONFIGURATIONS

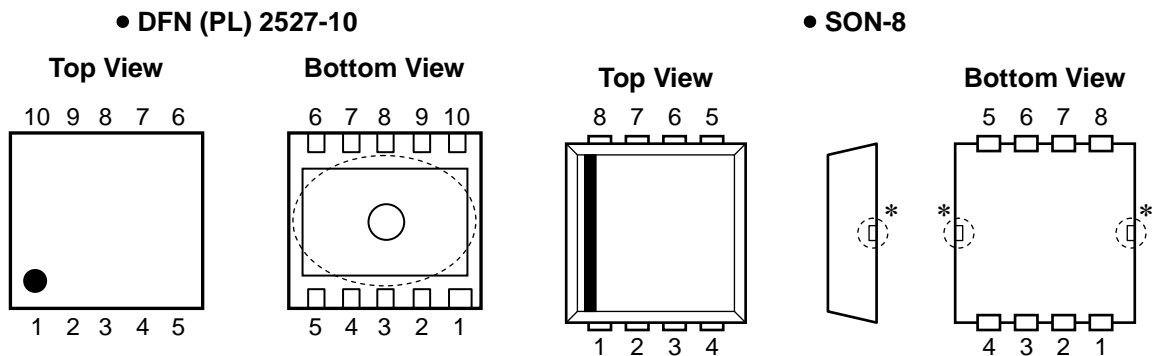

PIN DESCRIPTIONS

• DFN(PL)2527-10

Pin No	Symbol	Pin Description
1	V _{DD}	Input Pin
2	V _{DD}	Input Pin
3	CE1	Chip Enable Pin 1 ("H" Active)
4	CE2	Chip Enable Pin 2 ("H" Active)
5	CE3	Chip Enable Pin 3 ("H" Active)
6	GND	Ground Pin
7	NC	No Connection
8	V _{OUT3}	Output Pin 3
9	V _{OUT2}	Output Pin 2
10	V _{OUT1}	Output Pin 1

*) Tab is GND level. (They are connected to the reverse side of this IC.)
 The tab is better to be connected to the GND, but leaving it open is also acceptable.
 The V_{DD} pin must be wired together when it is mounted on board.

• SON-8

Pin No	Symbol	Pin Description
1	V _{DD}	Input Pin
2	CE1	Chip Enable Pin 1 ("H" Active)
3	CE2	Chip Enable Pin 2 ("H" Active)
4	CE3	Chip Enable Pin 3 ("H" Active)
5	GND	Ground Pin
6	V _{OUT3}	Output Pin 3
7	V _{OUT2}	Output Pin 2
8	V _{OUT1}	Output Pin 1

*) Tab suspension leads are GND level. (They are connected to the reverse side of this IC.)
 The tab suspension leads should be open and do not connect to other wires or land patterns.

* R5324D (SON-8) is the discontinued product. As of March in 2015.

R5324x

ABSOLUTE MAXIMUM RATINGS

Symbol	Item	Rating	Unit
V _{IN}	Input Voltage	6.5	V
CE	Input Voltage (CE Pin)	-0.3 to 6.5	V
V _{OUT}	Output Voltage	-0.3 to V _{IN} +0.3	V
I _{OUT1}	Output Current (V _{OUT1})	230	mA
I _{OUT2}	Output Current (V _{OUT2})	180	mA
I _{OUT3}	Output Current (V _{OUT3})	180	mA
P _D	Power Dissipation (DFN(PL)2527-10)*	910	mW
	Power Dissipation (SON-8)*	480	
T _{opt}	Operating Temperature Range	-40 to 85	°C
T _{stg}	Storage Temperature Range	-55 to 125	°C

*) For Power Dissipation, please refer to PACKAGE INFORMATION.

ABSOLUTE MAXIMUM RATINGS

Electronic and mechanical stress momentarily exceeded absolute maximum ratings may cause the permanent damages and may degrade the life time and safety for both device and system using the device in the field.

The functional operation at or over these absolute maximum ratings is not assured.

RECOMMENDED OPERATING CONDITIONS (ELECTRICAL CHARACTERISTICS)

All of electronic equipment should be designed that the mounted semiconductor devices operate within the recommended operating conditions. The semiconductor devices cannot operate normally over the recommended operating conditions, even if when they are used over such conditions by momentary electronic noise or surge. And the semiconductor devices may receive serious damage when they continue to operate over the recommended operating conditions.

* R5324D (SON-8) is the discontinued product. As of March in 2015.

R5324x

ELECTRICAL CHARACTERISTICS

• R5324xxxxA/B

VR1

T_{opt}=25°C

Symbol	Item	Conditions	Min.	Typ.	Max.	Unit	
V _{OUT}	Output Voltage	V _{IN} -V _{OUT} =1.0V 1mA ≤ I _{OUT} ≤ 30mA	×0.98		×1.02	V	
I _{OUT}	Output Current	V _{IN} -V _{OUT} =1.0V	200			mA	
ΔV _{OUT} /ΔI _{OUT}	Load Regulation	V _{IN} -V _{OUT} =1.0V, 1mA ≤ I _{OUT} ≤ 200mA		25	50	mV	
V _{DIF}	Dropout Voltage	I _{OUT} =200mA	V _{OUT} =1.5V		0.36	0.65	V
			V _{OUT} =1.6V		0.34	0.58	
			V _{OUT} =1.7V		0.33	0.56	
			1.8V ≤ V _{OUT} ≤ 2.0V		0.31	0.53	
			2.1V ≤ V _{OUT} ≤ 2.7V		0.28	0.46	
			2.8V ≤ V _{OUT} ≤ 4.0V		0.23	0.35	
I _{SS}	Supply Current	V _{IN} -V _{OUT} =1.0V		90	140	μA	
I _{standby}	Standby Current	V _{IN} -V _{OUT} =1.0V, V _{CE} =GND		0.1	1.0	μA	
ΔV _{OUT} /ΔV _{IN}	Line Regulation	I _{OUT} =30mA, V _{OUT} +0.5V ≤ V _{IN} ≤ 6.0V (V _{OUT} ≤ 1.6V: 2.2V ≤ V _{IN} ≤ 6.0V)		0.02	0.10	%/V	
RR	Ripple Rejection	sinusoidal Ripple 0.5Vp-p V _{IN} -V _{OUT} =1.0V, I _{OUT} =30mA *V _{OUT} ≤ 1.7V, V _{IN} -V _{OUT} =1.2V, I _{OUT} =30mA	f=1kHz		70	dB	
			f=10kHz		65		
			f=10kHz (V _{OUT} ≥ 2.5V)		60		
V _{IN}	Input Voltage		2		6	V	
ΔV _{OUT} /ΔT _{opt}	Output Voltage Temperature Coefficient	I _{OUT} =30mA -40°C ≤ T _{opt} ≤ 85°C		±100		ppm /°C	
I _{SC}	Short Current Limit	V _{OUT} =0V		50		mA	
R _{PD}	CE Pull-down Resistance		0.7	2.0	5.0	MΩ	
V _{CEH}	CE Input Voltage "H"		1.5		6.0	V	
V _{CEL}	CE Input Voltage "L"		0		0.3	V	
en	Output Noise	BW=10Hz to 100kHz		30		μVrms	
R _{LOW}	On Resistance of Nch Tr. for Auto-discharge (Applied to B version)	V _{CE} =0V		50		Ω	

* R5324D (SON-8) is the discontinued product. As of March in 2015.

R5324x

VR2

T_{opt}=25°C

Symbol	Item	Conditions	Min.	Typ.	Max.	Unit	
V _{OUT}	Output Voltage	V _{IN} -V _{OUT} =1.0V 1mA ≤ I _{OUT} ≤ 30mA	×0.98		×1.02	V	
I _{OUT}	Output Current	V _{IN} -V _{OUT} =1.0V	150			mA	
ΔV _{OUT} /ΔI _{OUT}	Load Regulation	V _{IN} -V _{OUT} =1.0V 1mA ≤ I _{OUT} ≤ 150mA		15	40	mV	
V _{DIF}	Dropout Voltage	I _{OUT} =150mA	V _{OUT} =1.5V		0.34	0.60	V
			V _{OUT} =1.6V		0.32	0.56	
			V _{OUT} =1.7V		0.31	0.53	
			1.8V ≤ V _{OUT} ≤ 2.0V		0.29	0.50	
			2.1V ≤ V _{OUT} ≤ 2.7V		0.26	0.44	
			2.8V ≤ V _{OUT} ≤ 4.0V		0.22	0.33	
I _{SS}	Supply Current	V _{IN} -V _{OUT} =1.0V		90	120	μA	
I _{standby}	Standby Current	V _{IN} -V _{OUT} =1.0V, V _{CE} =GND		0.1	1.0	μA	
ΔV _{OUT} /ΔV _{IN}	Line Regulation	I _{OUT} =30mA, V _{OUT} +0.5V ≤ V _{IN} ≤ 6.0V (V _{OUT} ≤ 1.6V: 2.2V ≤ V _{IN} ≤ 6.0V)		0.02	0.10	%/V	
RR	Ripple Rejection	sinusoidal Ripple 0.5Vp-p V _{IN} -V _{OUT} =1.0V, I _{OUT} =30mA *V _{OUT} ≤ 1.7V, V _{IN} -V _{OUT} =1.2V, I _{OUT} =30mA	f=1kHz		70		dB
			f=10kHz		65		
			f=10kHz (V _{OUT} ≥ 2.5V)		60		
V _{IN}	Input Voltage		2		6	V	
ΔV _{OUT} /ΔT _{opt}	Output Voltage Temperature Coefficient	I _{OUT} =30mA -40°C ≤ T _{opt} ≤ 85°C		±100		ppm /°C	
I _{SC}	Short Current Limit	V _{OUT} =0V		40		mA	
R _{PD}	CE Pull-down Resistance		0.7	2.0	5.0	MΩ	
V _{CEH}	CE Input Voltage "H"		1.5		6.0	V	
V _{CEL}	CE Input Voltage "L"		0		0.3	V	
en	Output Noise	BW=10Hz to 100kHz		30		μVrms	
R _{LOW}	On Resistance of Nch Tr. for Auto-discharge (Applied to B version)	V _{CE} =0V		50		Ω	

* R5324D (SON-8) is the discontinued product. As of March in 2015.

R5324x

VR3

T_{opt}=25°C

Symbol	Item	Conditions	Min.	Typ.	Max.	Unit	
V _{OUT}	Output Voltage	V _{IN} -V _{OUT} =1.0V 1mA ≤ I _{OUT} ≤ 30mA	×0.98		×1.02	V	
I _{OUT}	Output Current	V _{IN} -V _{OUT} =1.0V	100			mA	
ΔV _{OUT} /ΔI _{OUT}	Load Regulation	V _{IN} -V _{OUT} =1.0V 1mA ≤ I _{OUT} ≤ 100mA		8	20	mV	
V _{DIF}	Dropout Voltage	I _{OUT} =100mA	V _{OUT} =1.5V		0.24	0.44	V
			V _{OUT} =1.6V		0.22	0.40	
			V _{OUT} =1.7V		0.21	0.38	
			1.8V ≤ V _{OUT} ≤ 2.0V		0.20	0.37	
			2.1V ≤ V _{OUT} ≤ 2.7V		0.18	0.33	
			2.8V ≤ V _{OUT} ≤ 4.0V		0.15	0.25	
I _{SS}	Supply Current	V _{IN} -V _{OUT} =1.0V		90	120	μA	
I _{standby}	Standby Current	V _{IN} -V _{OUT} =1.0V, V _{CE} =GND		0.1	1.0	μA	
ΔV _{OUT} /ΔV _{IN}	Line Regulation	I _{OUT} =30mA, V _{OUT} +0.5V ≤ V _{IN} ≤ 6.0V (V _{OUT} ≤ 1.6V: 2.2V ≤ V _{IN} ≤ 6.0V)		0.02	0.10	%/V	
RR	Ripple Rejection	sinusoidal Ripple 0.5Vp-p V _{IN} -V _{OUT} =1.0V, I _{OUT} =30mA *V _{OUT} ≤ 1.7V, V _{IN} -V _{OUT} =1.2V, I _{OUT} =30mA	f=1kHz		70		dB
			f=10kHz		65		
			f=10kHz (V _{OUT} ≥ 2.5V)		60		
V _{IN}	Input Voltage		2		6	V	
ΔV _{OUT} /ΔT _{opt}	Output Voltage Temperature Coefficient	I _{OUT} =30mA -40°C ≤ T _{opt} ≤ 85°C		±100		ppm /°C	
I _{SC}	Short Current Limit	V _{OUT} =0V		40		mA	
R _{PD}	CE Pull-down Resistance		0.7	2.0	5.0	MΩ	
V _{CEH}	CE Input Voltage "H"		1.5		6.0	V	
V _{CEL}	CE Input Voltage "L"		0		0.3	V	
en	Output Noise	BW=10Hz to 100kHz		30		μVrms	
R _{LOW}	On Resistance of Nch Tr. for Auto-discharge (Applied to B version)	V _{CE} =0V		50		Ω	

OPERATION

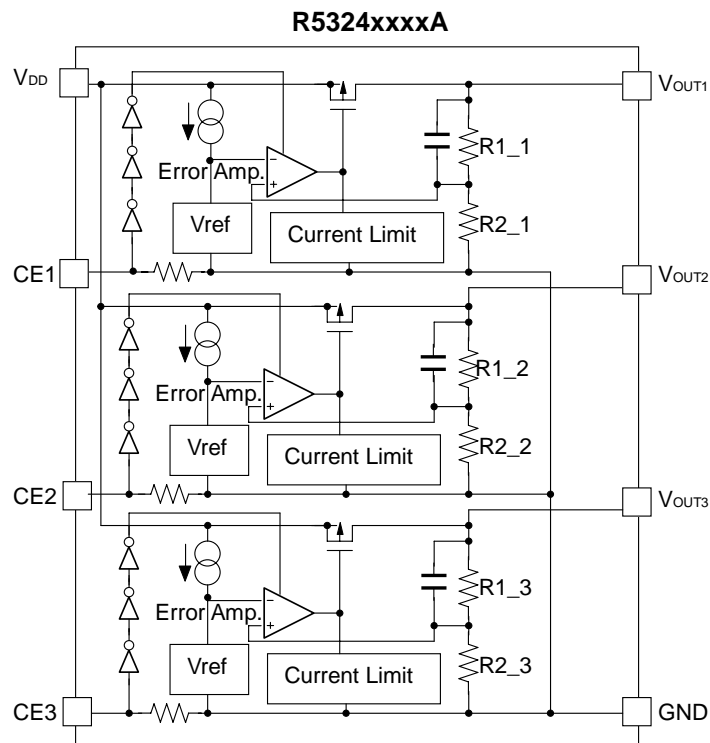

Fluctuation of each regulator's output voltage, or V_{OUT1} , V_{OUT2} , V_{OUT3} is detected individually. Then it is put back to an error amplifier through feedback resistors, or $R1_1$, $R2_1$, $R1_2$, $R2_2$, $R1_3$, $R2_3$ and compared with a reference voltage and compensated for the result and make a constant voltage.

In each regulator, short protection is made with a current limit circuit and stand-by mode is available by a chip enable circuit.

R5324x

TYPICAL APPLICATION

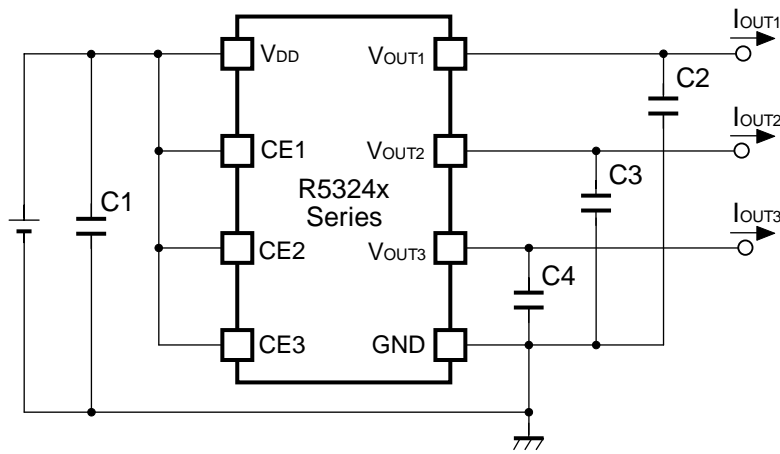

(External Components)

Output Capacitor : Ceramic 1.0 μ F or more

TECHNICAL NOTES

When using these ICs, consider the following points:

Phase Compensation

In these ICs, phase compensation is made for securing stable operation even if the load current is varied. For this purpose, use a capacitor C2, C3 and C4 with 1.0 μ F or more.

If a tantalum capacitor is used, and its ESR (Equivalent Series Resistance) of C2, C3 and C4 is large, the loop oscillation may result. Because of this, select C2, C3 and C4 carefully considering its frequency characteristics.

PCB Layout

Make V_{DD} and GND lines sufficient. If their impedance is high, noise pickup or unstable operation may result. Connect a capacitor C1 with a capacitance value as much as 1.0 μ F or more between V_{DD} and GND pin, and as close as possible to the pins.

Set external components, especially the output capacitor C2, C3 and C4 as close as possible to the ICs, and make wiring as short as possible.

TEST CIRCUIT

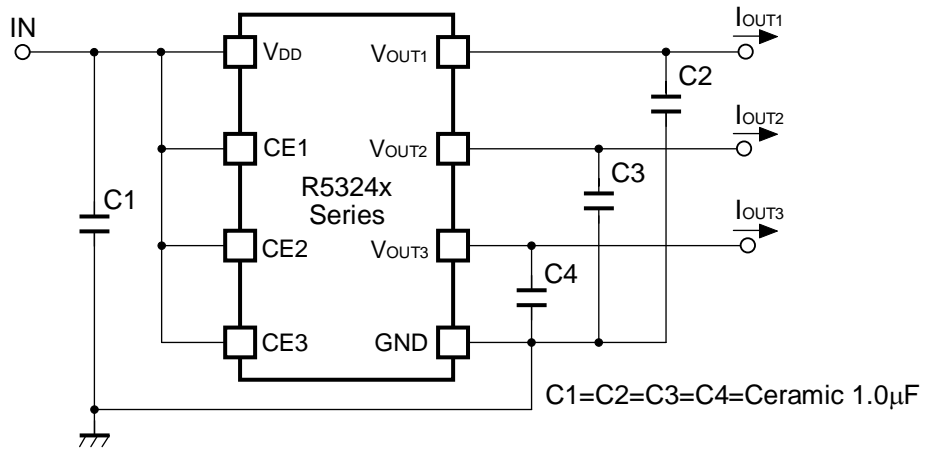

Basic Test Circuit

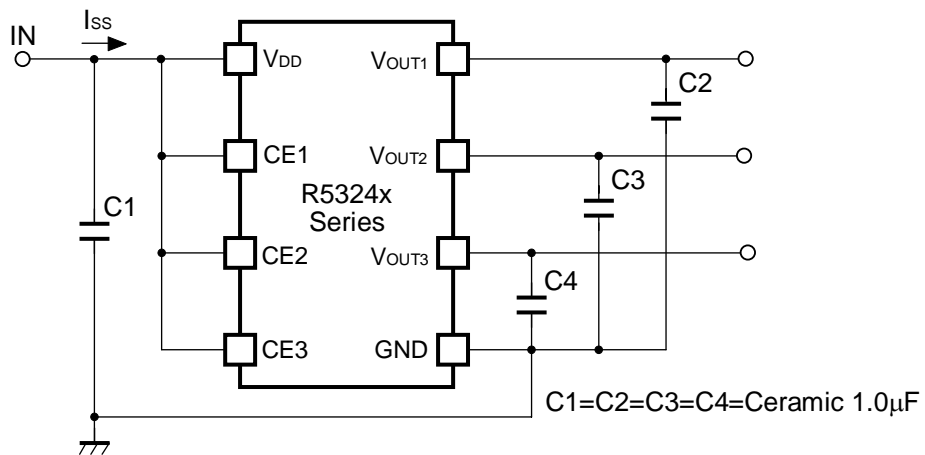

Test Circuit for Supply Current

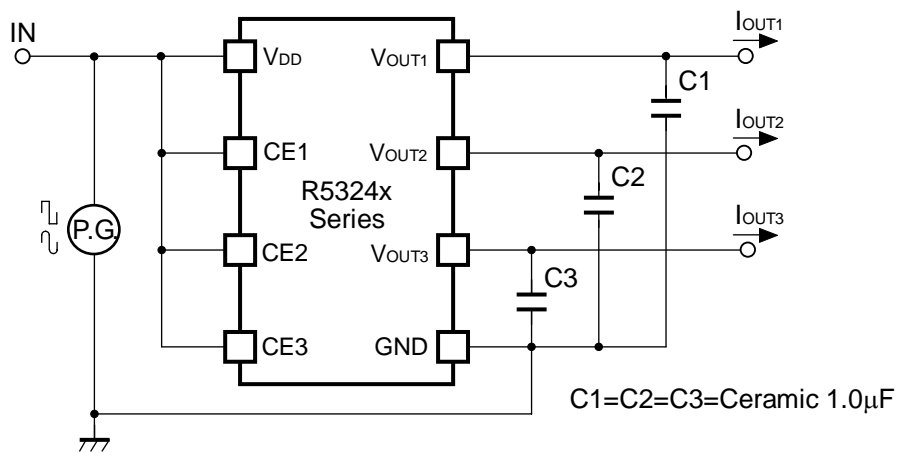

Test Circuit for Ripple Rejection, Input Transient Response

* R5324D (SON-8) is the discontinued product. As of March in 2015.

R5324x

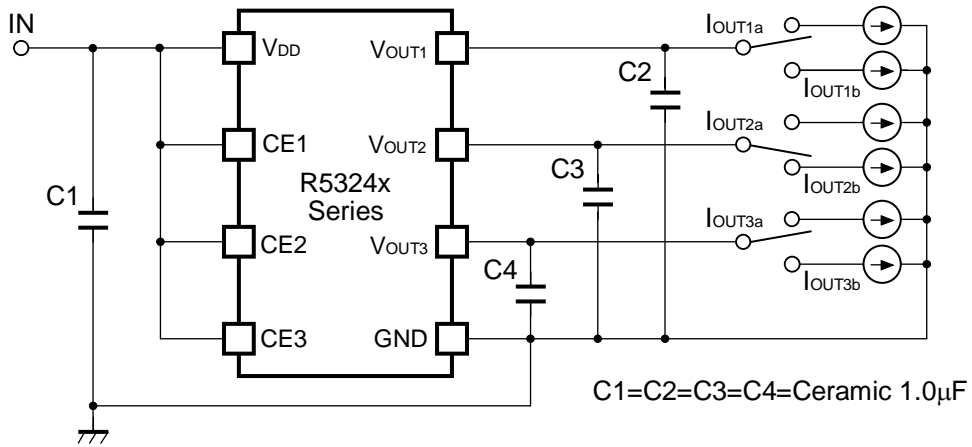

Test Circuit for Load Transient Response

TYPICAL CHARACTERISTICS

1) Output Voltage vs. Output Current (Topt=25°C)

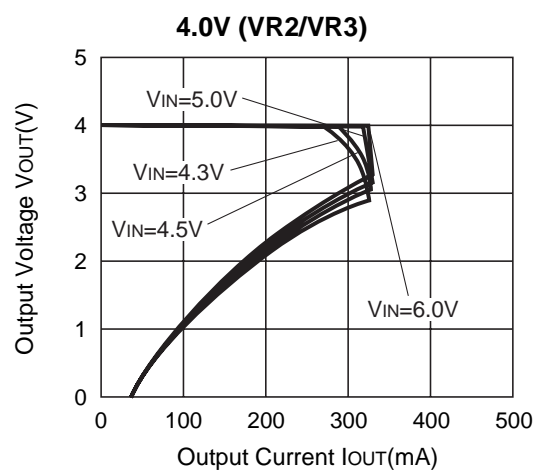
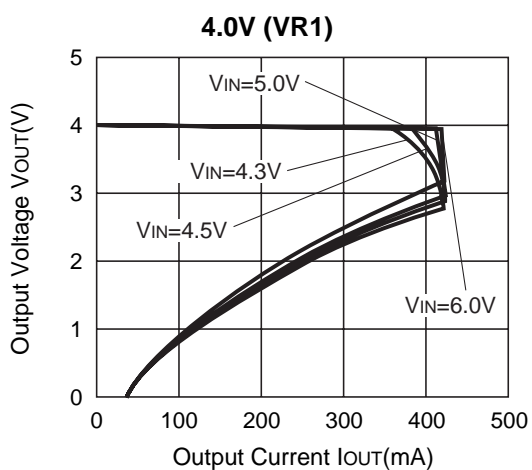
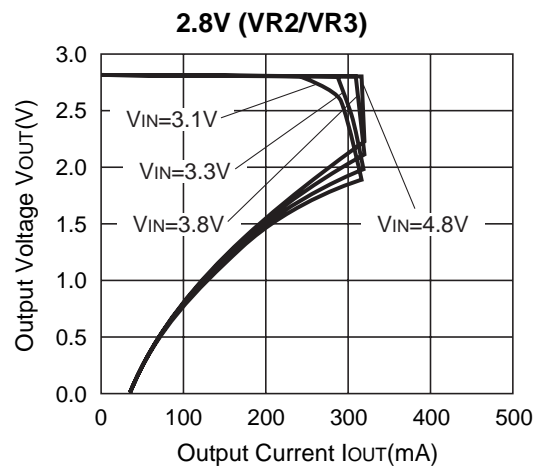
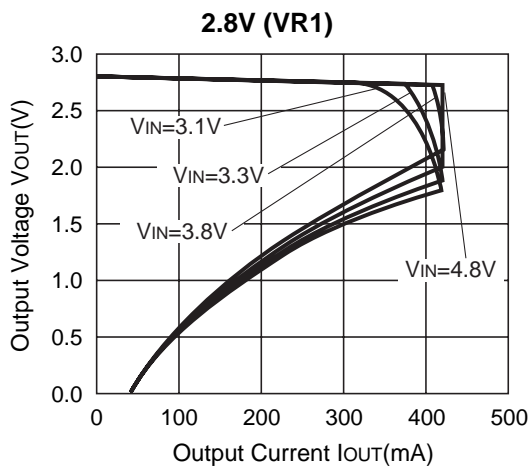
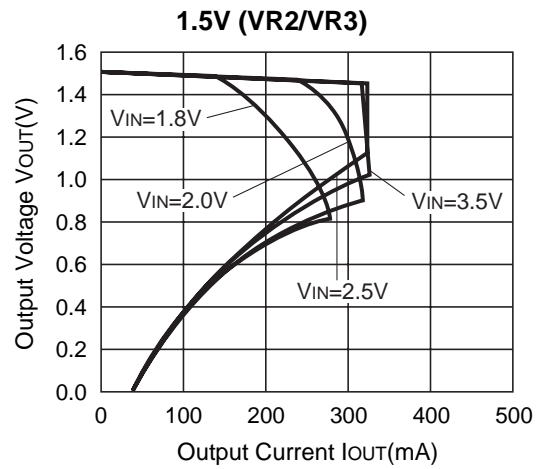
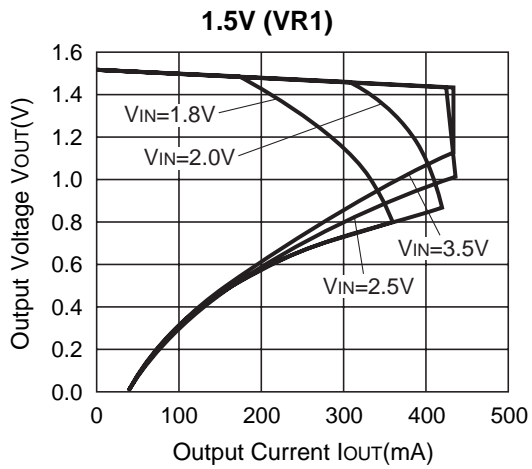

* R5324D (SON-8) is the discontinued product. As of March in 2015.

R5324x

2) Output Voltage vs. Input Voltage ($T_{opt}=25^{\circ}\text{C}$)

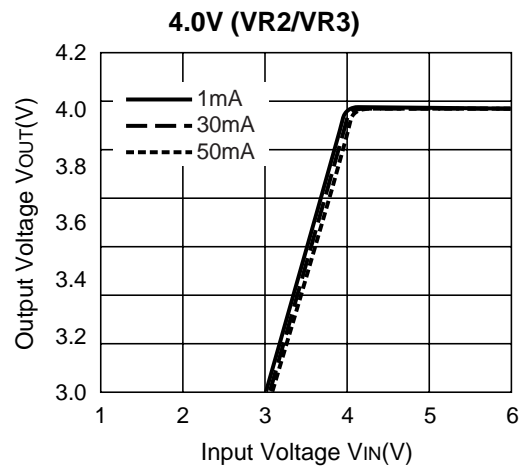
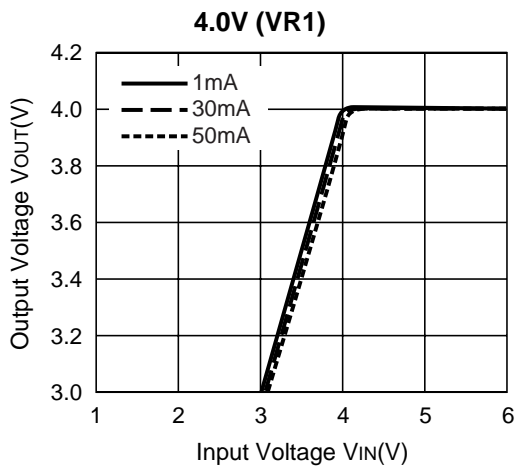
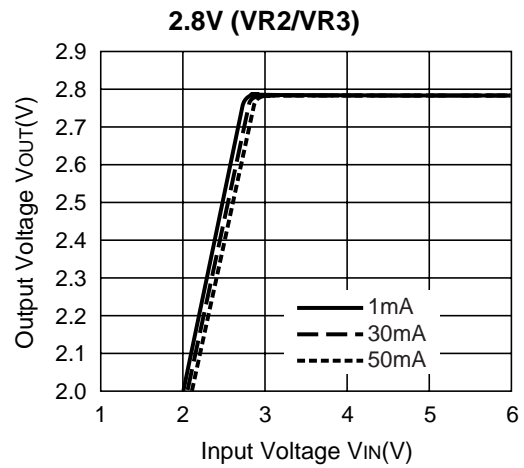
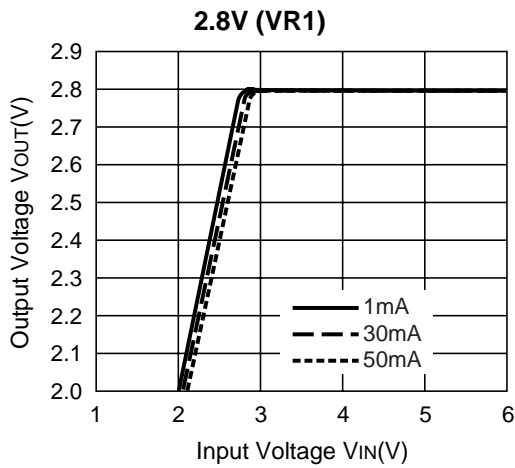
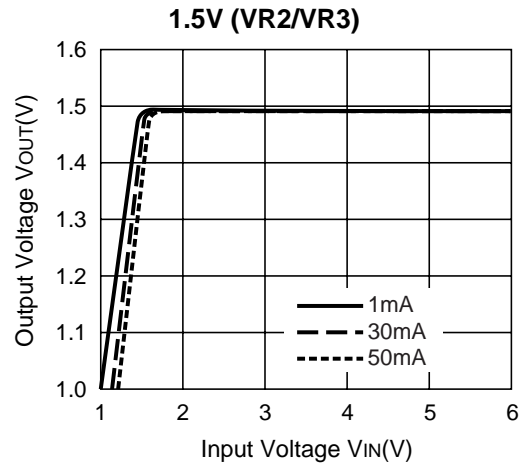
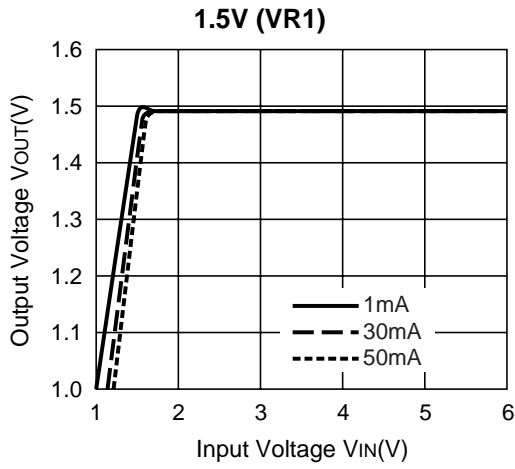

3) Dropout Voltage vs. Output Current

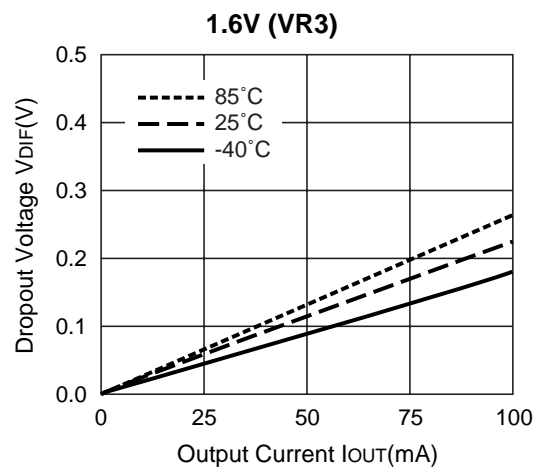
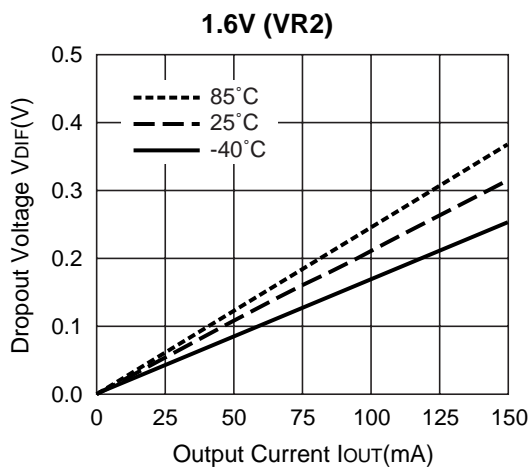
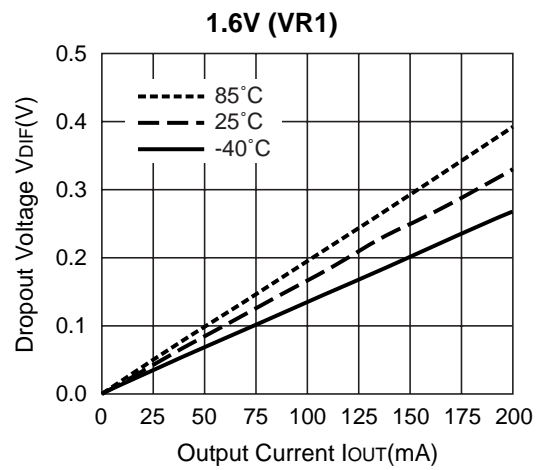
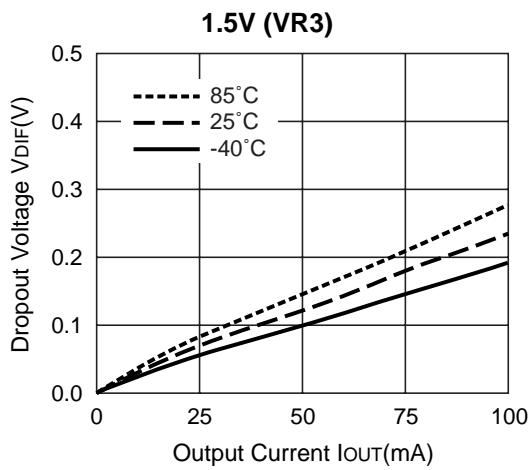
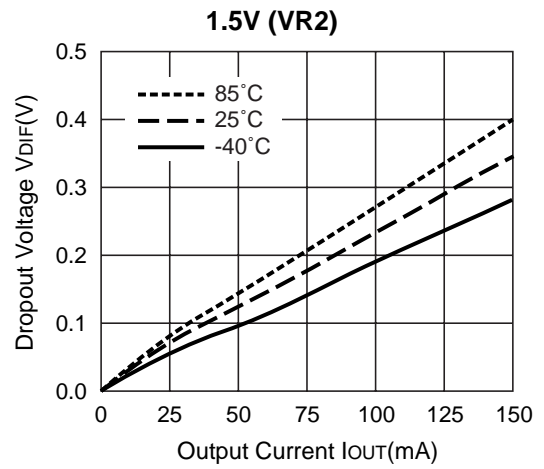
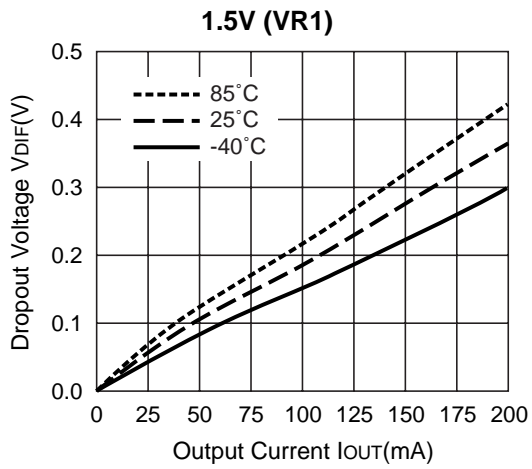

* R5324D (SON-8) is the discontinued product. As of March in 2015.

R5324x

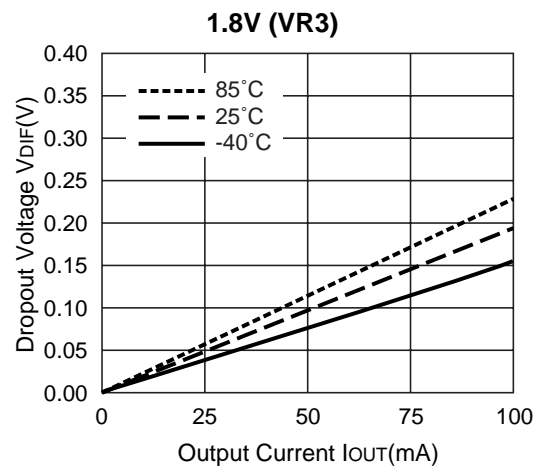
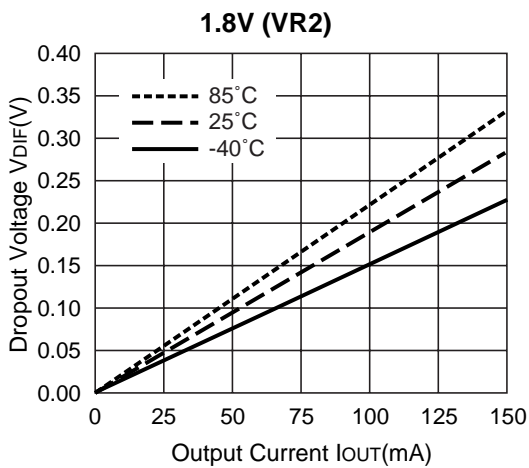
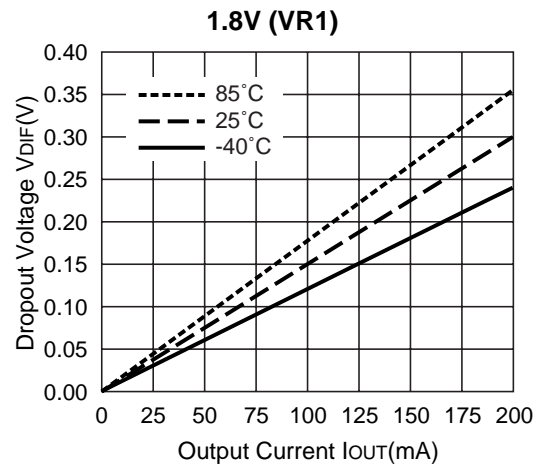
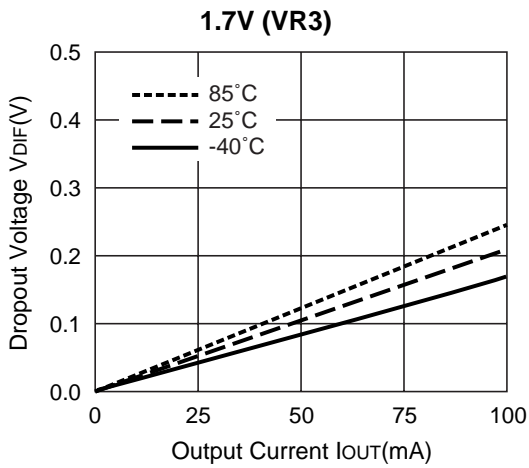
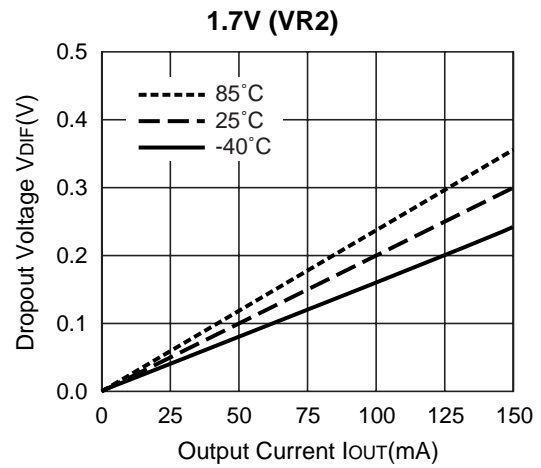
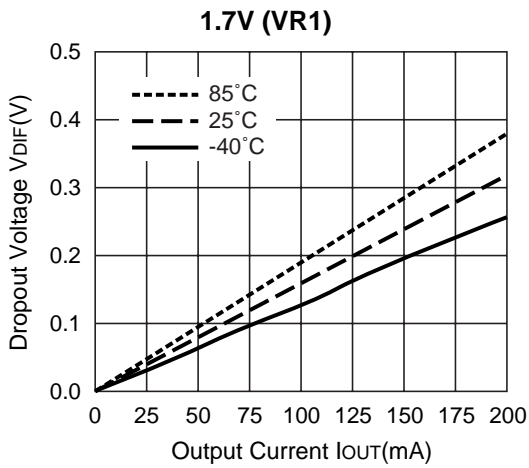

* R5324D (SON-8) is the discontinued product. As of March in 2015.

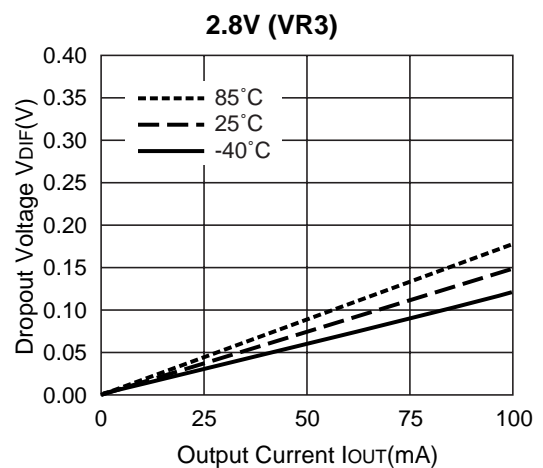
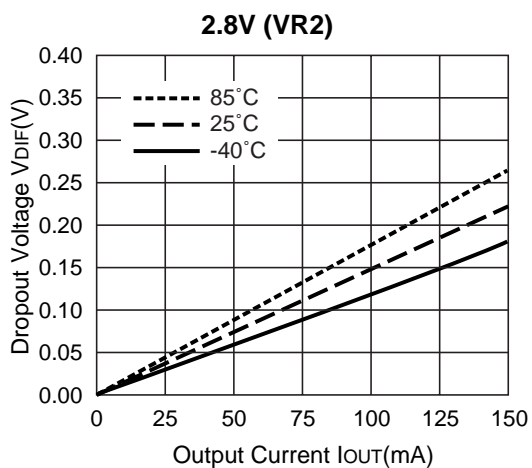
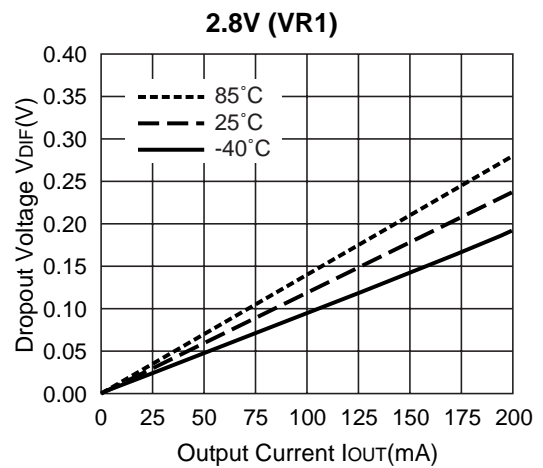
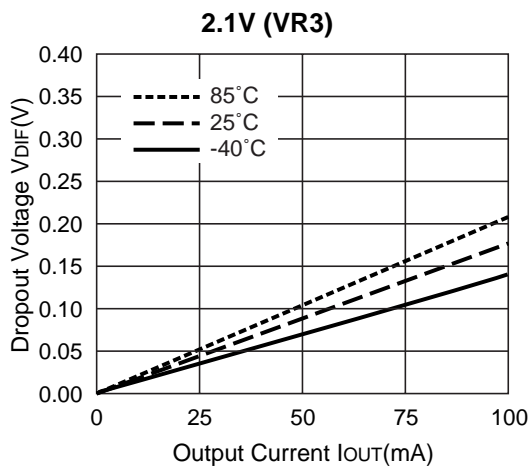
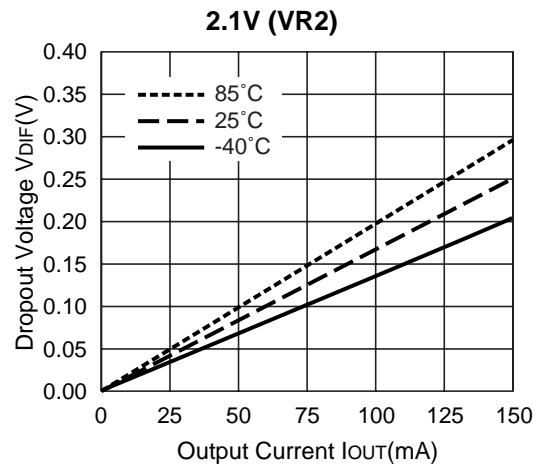
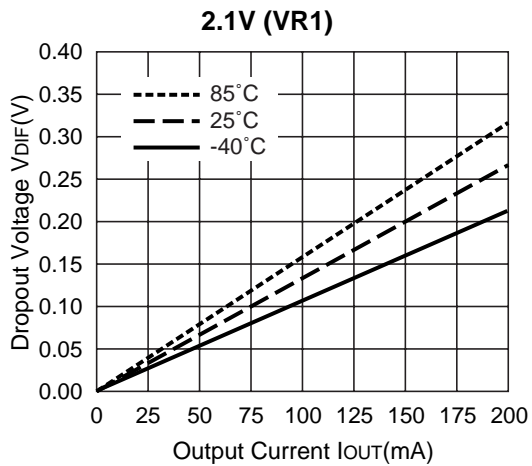

* R5324D (SON-8) is the discontinued product. As of March in 2015.

R5324x

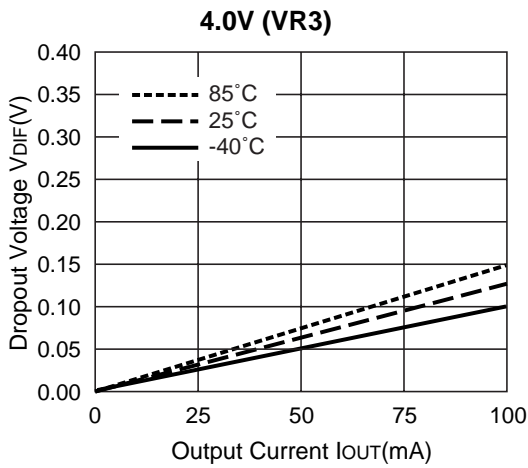
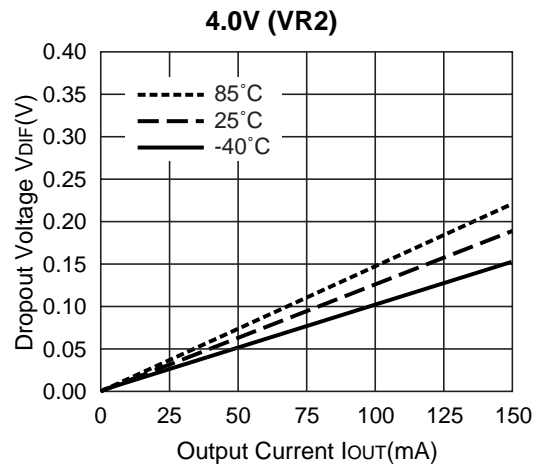
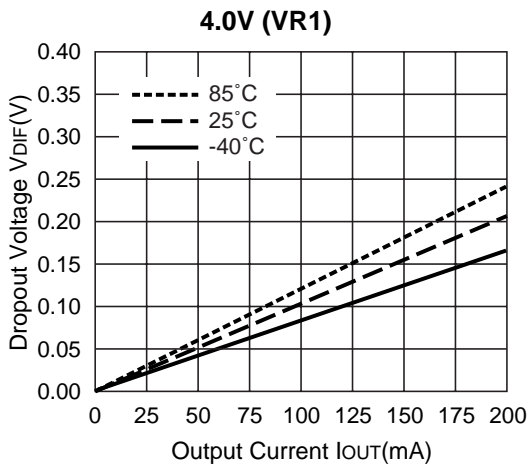

4) Output Voltage vs. Temperature ($I_{OUT}=30mA$)

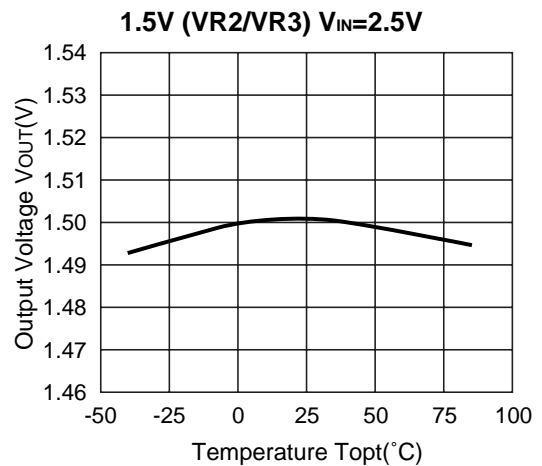
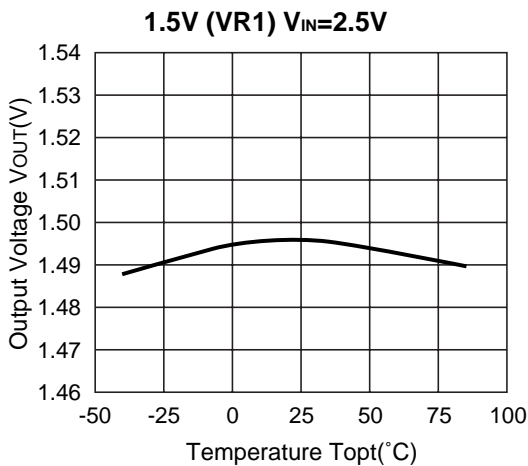

* R5324D (SON-8) is the discontinued product. As of March in 2015.

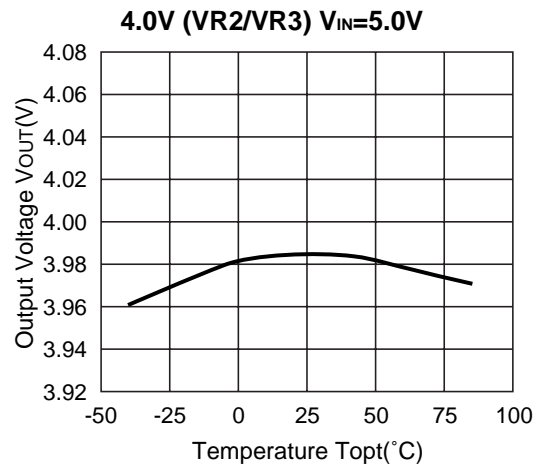
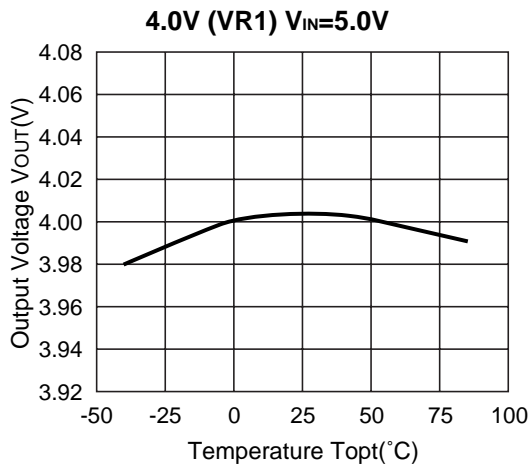
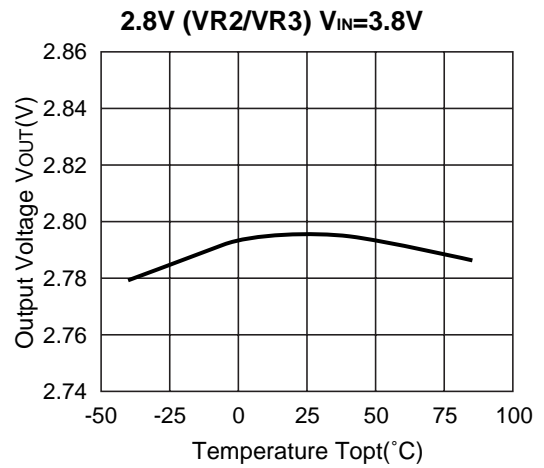
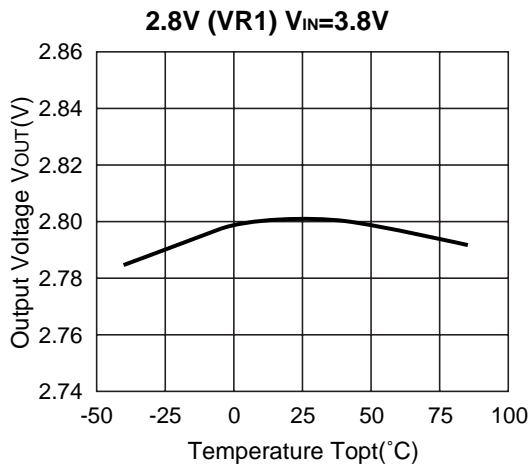

5) Supply Current vs. Input Voltage ($T_{opt}=25^{\circ}C$)

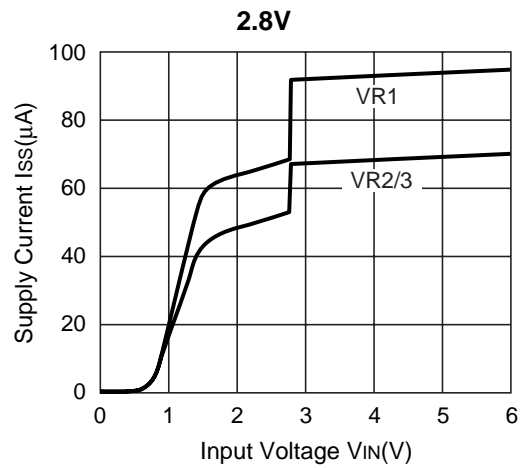
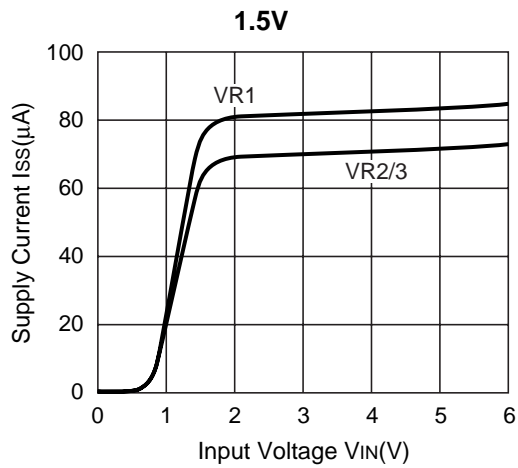

* R5324D (SON-8) is the discontinued product. As of March in 2015.

R5324x

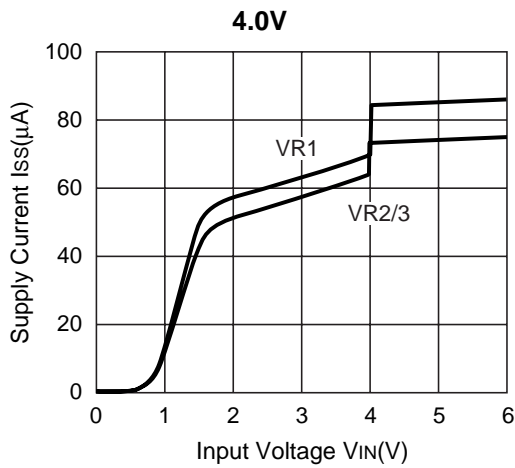

6) Supply Current vs. Temperature

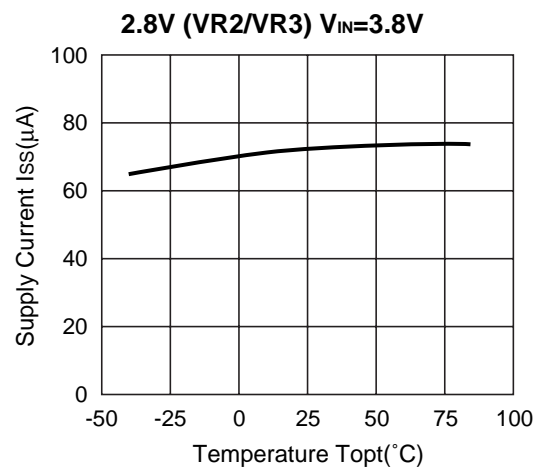
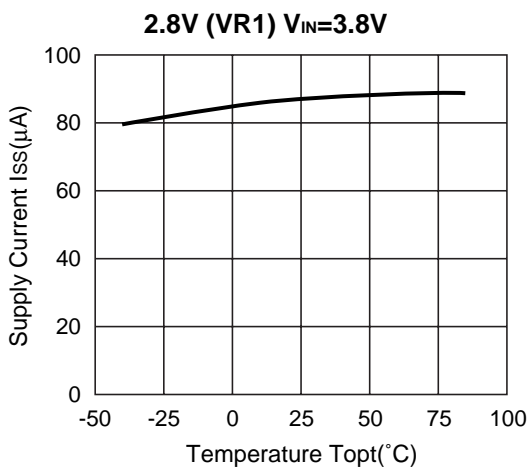
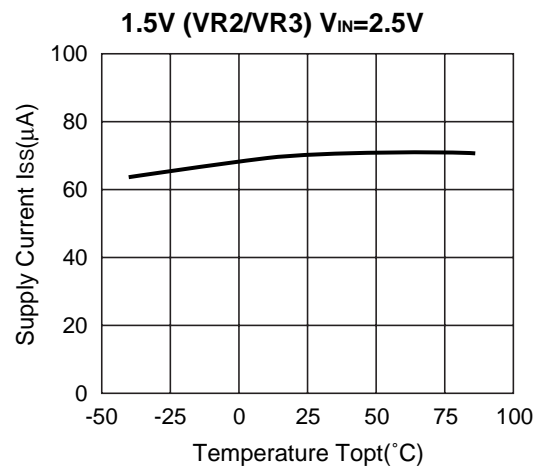
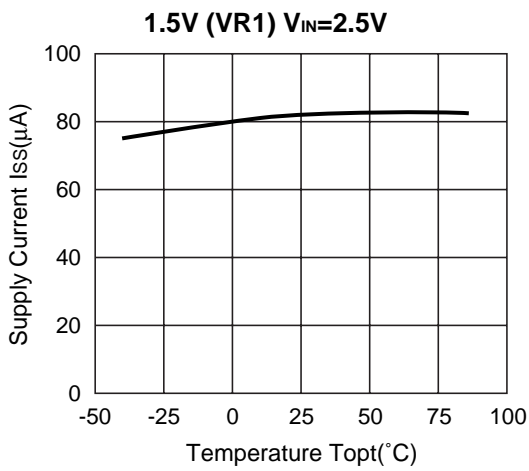

* R5324D (SON-8) is the discontinued product. As of March in 2015.

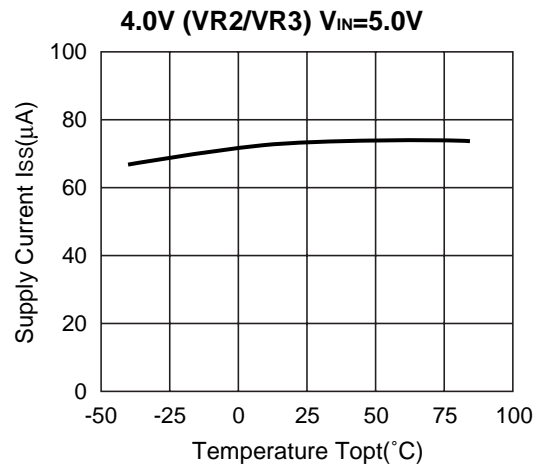
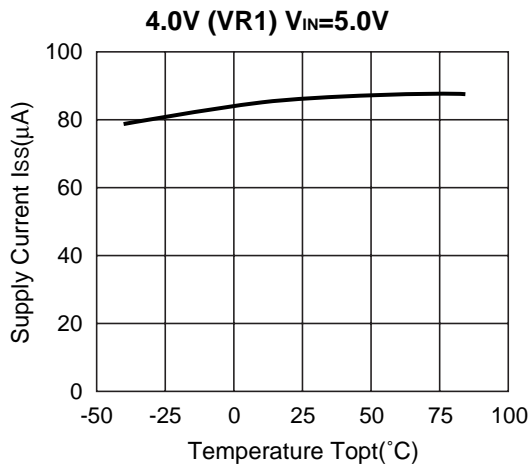

7) Dropout Voltage vs. Set Output Voltage ($T_{opt}=25^{\circ}C$)

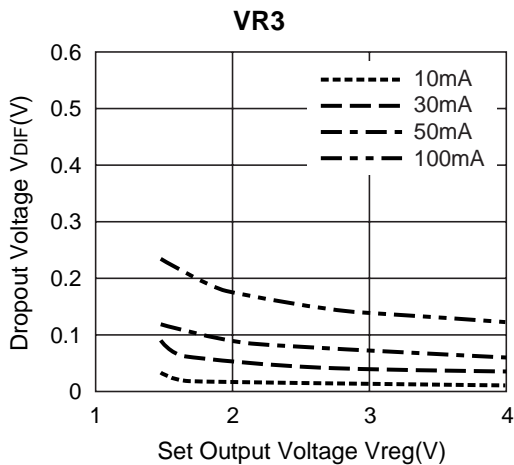
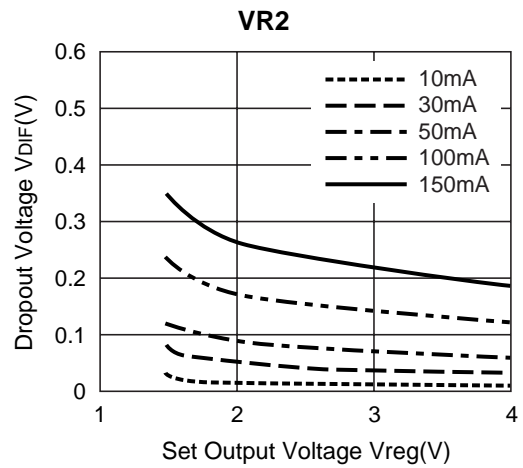
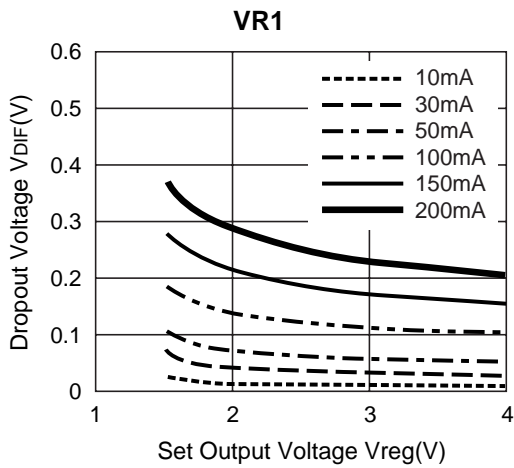

R5324x

8) Ripple Rejection vs. Frequency (Topt=25°C, COUT=Ceramic 1.0μF)

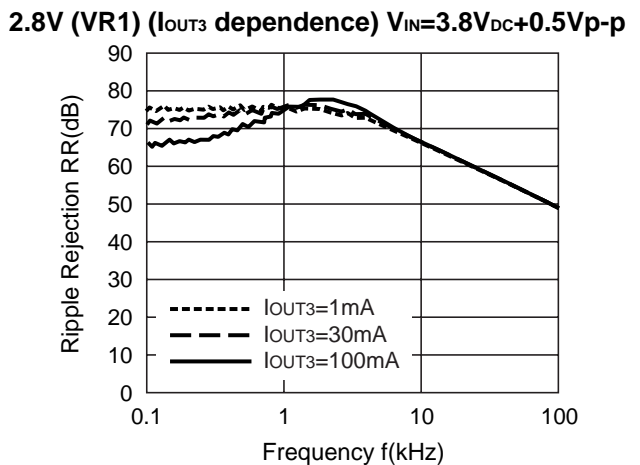
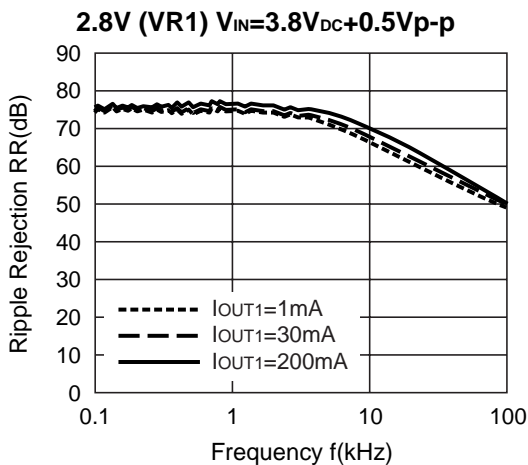
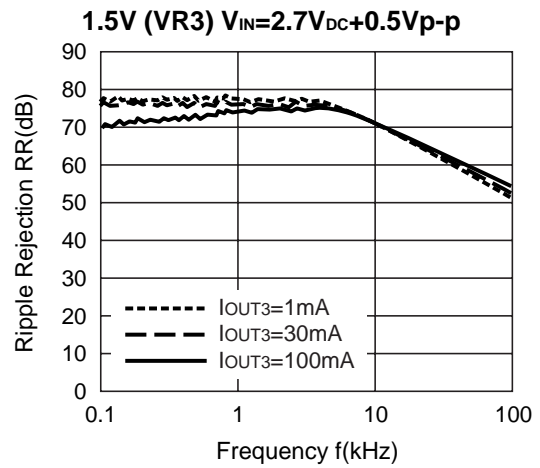
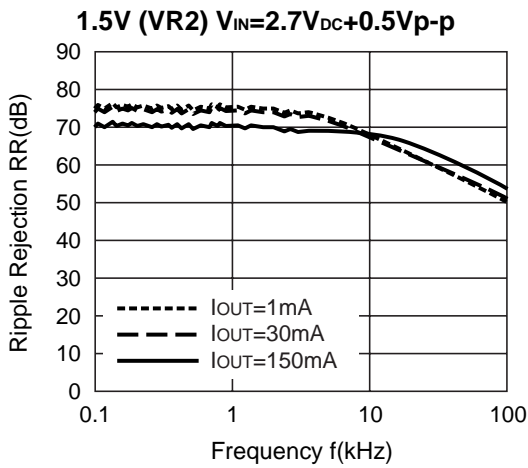
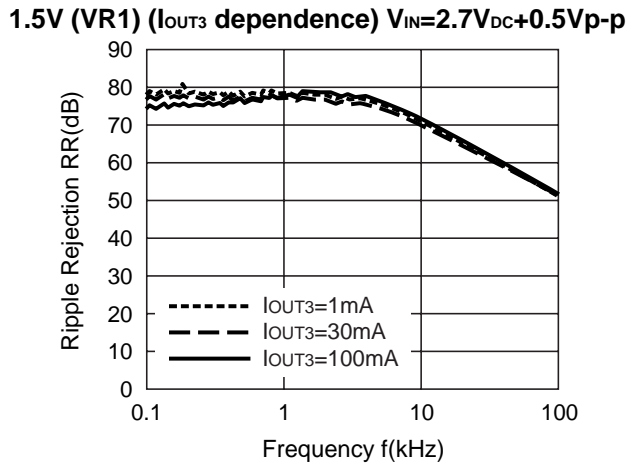
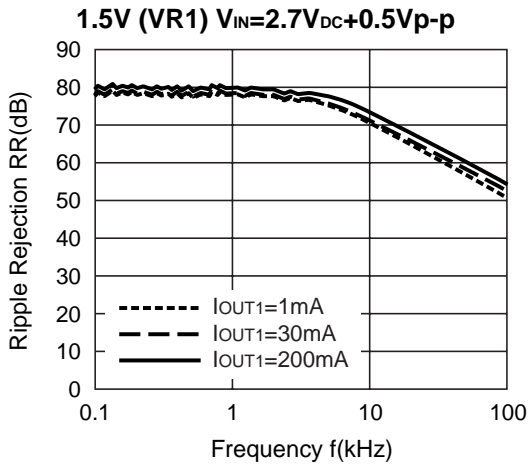

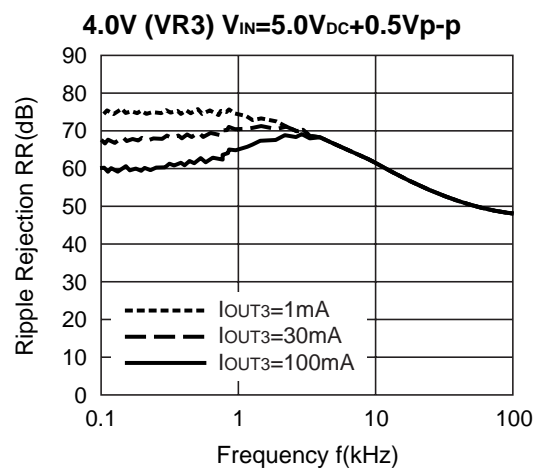
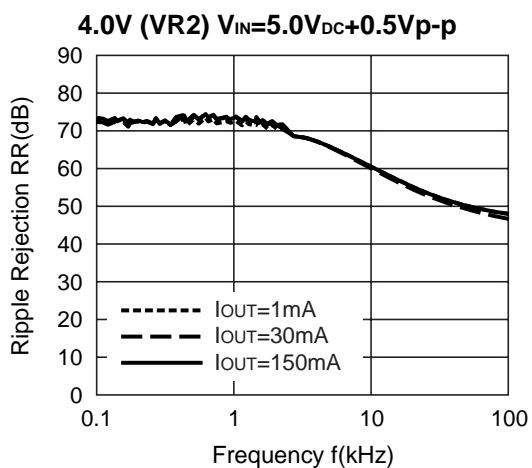
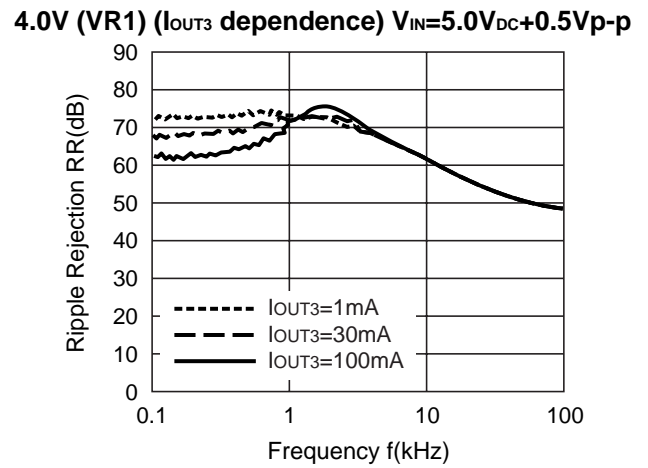
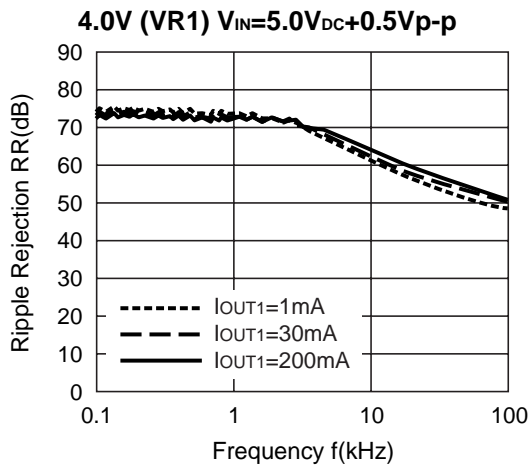
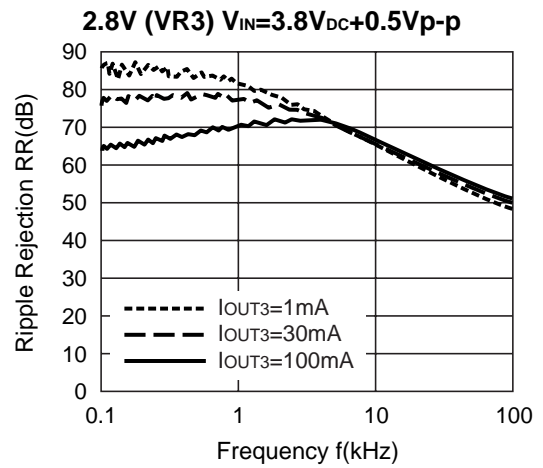
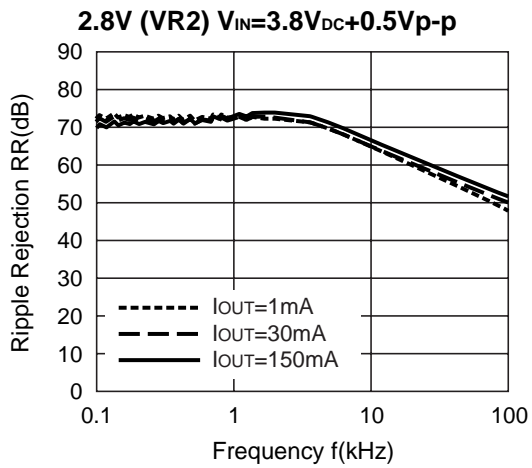

R5324x

9) Ripple Rejection vs. DC Input Bias (T_{opt}=25°C, C_{OUT}=1.0μF)

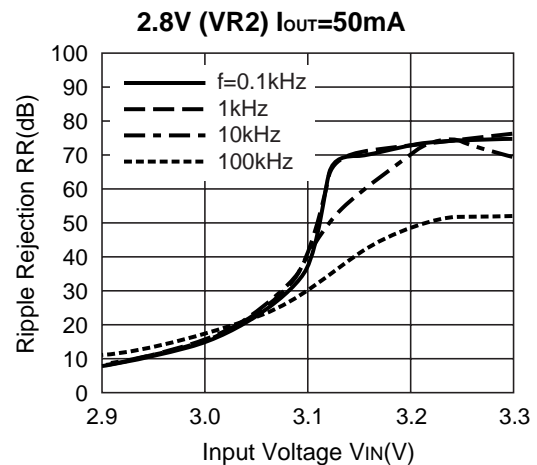
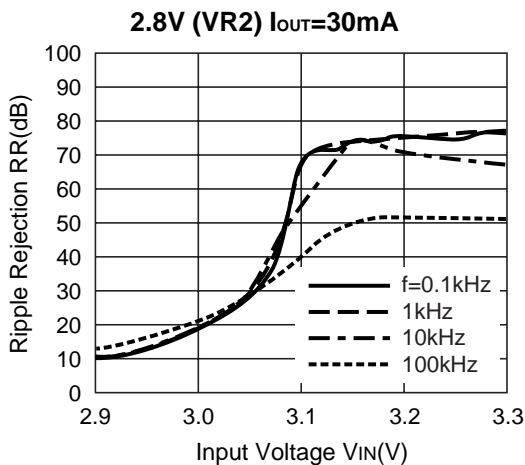
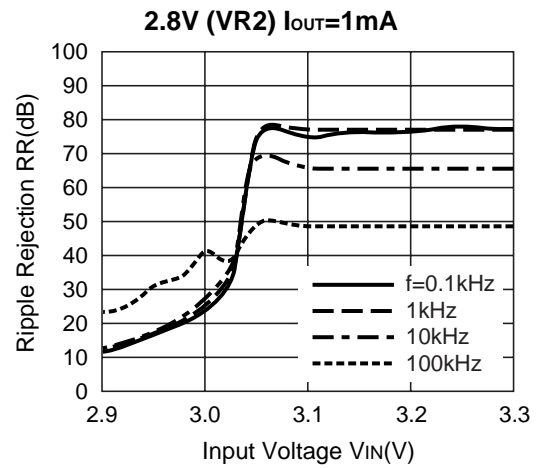
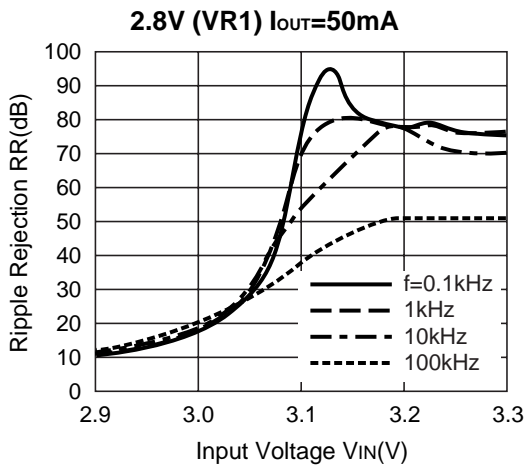
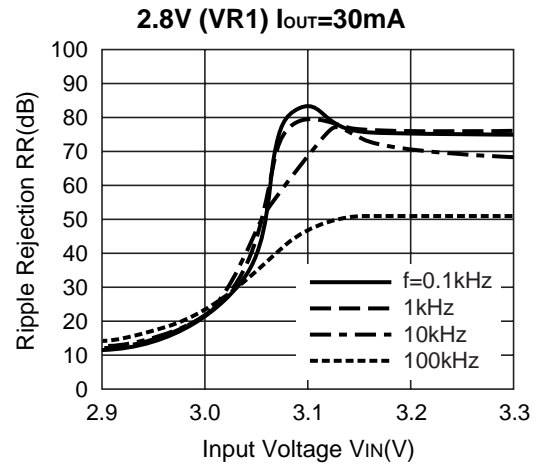
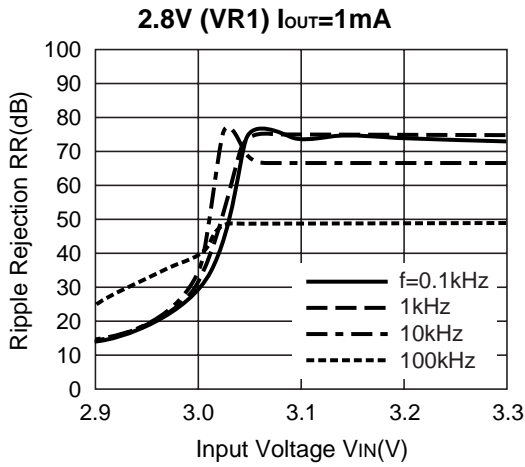

* R5324D (SON-8) is the discontinued product. As of March in 2015.

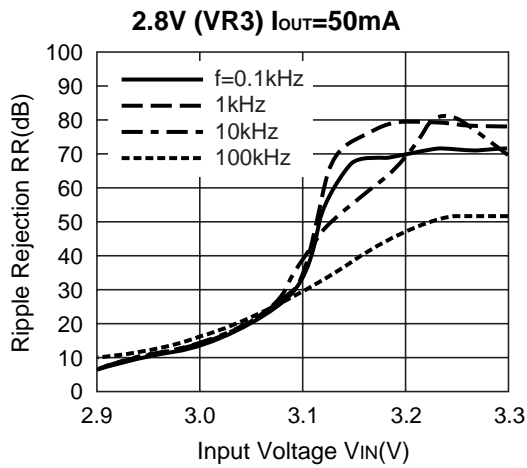
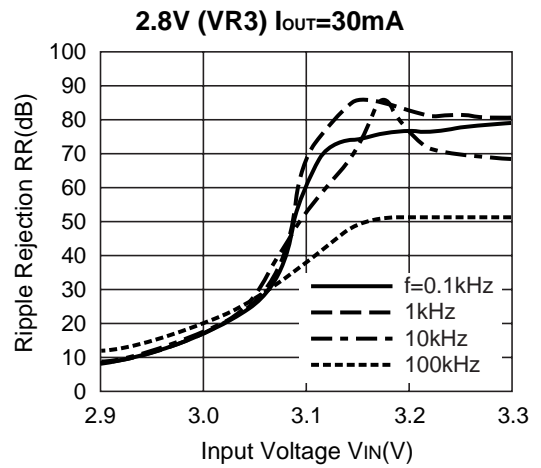
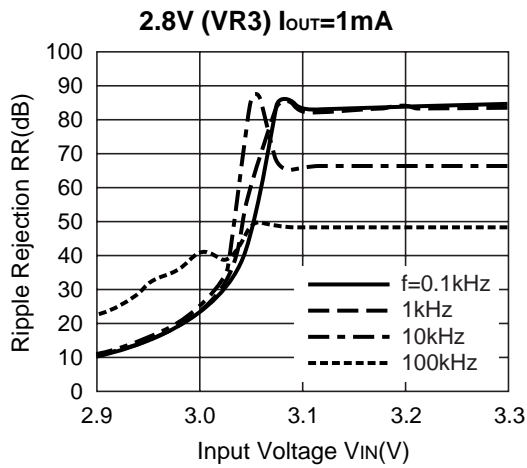

* R5324D (SON-8) is the discontinued product. As of March in 2015.

R5324x

10) Line Transient Response ($I_{OUT}=30mA$, $C_{IN}=none$, $t_r=t_f=5\mu s$, $C_{OUT}=Ceramic\ 1\mu F$)

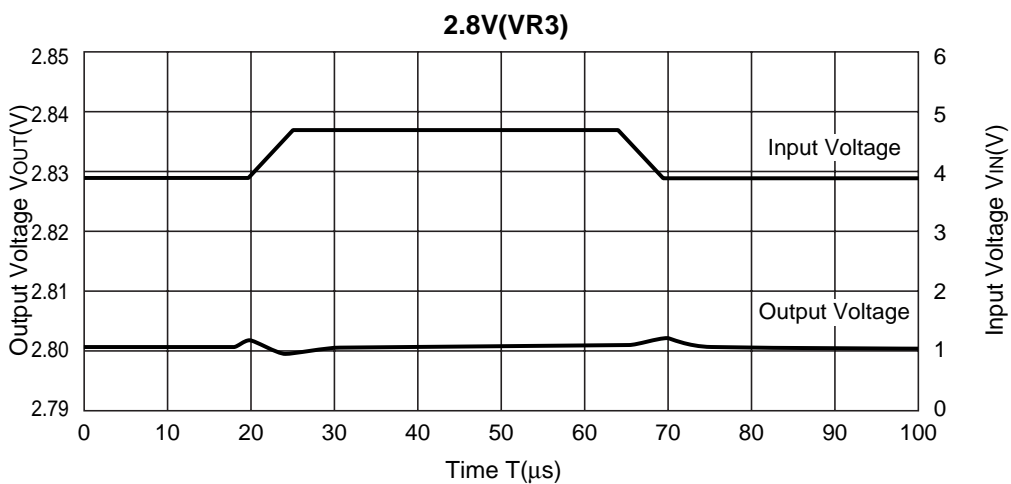
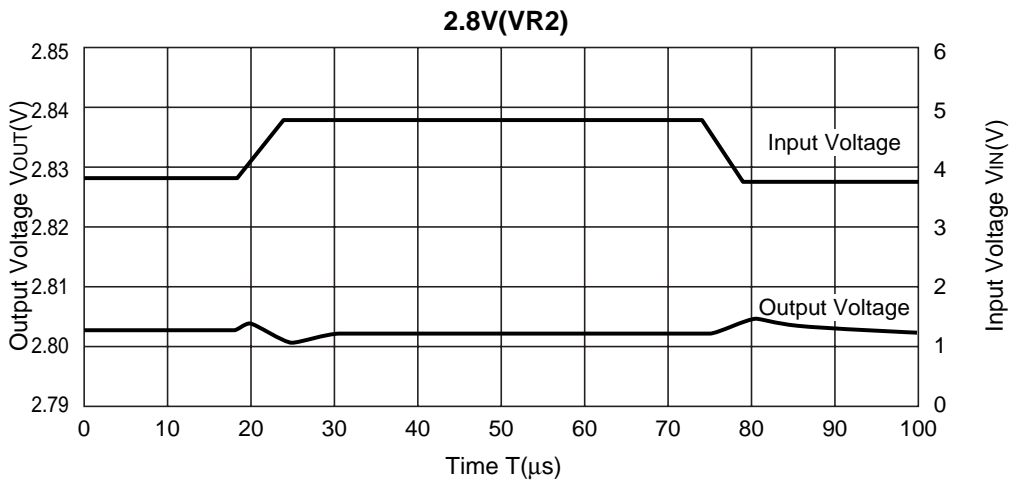
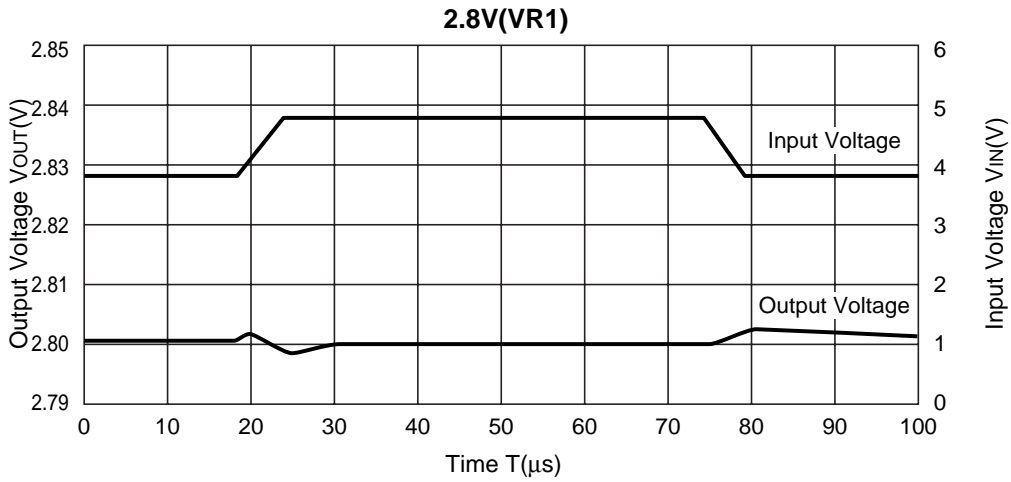

* R5324D (SON-8) is the discontinued product. As of March in 2015.

11) Load Transient Response (C_{IN} =Ceramic $1.0\mu\text{F}$, C_{OUT} =Ceramic $1.0\mu\text{F}$)

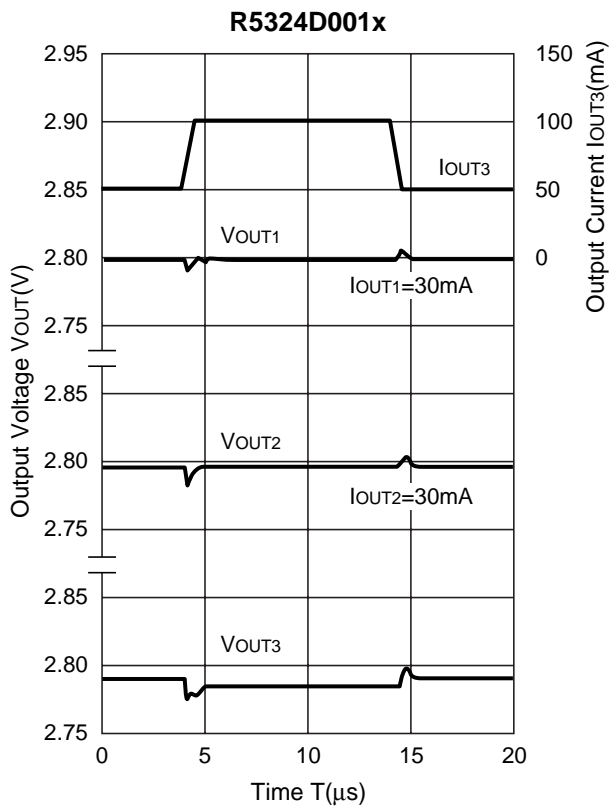
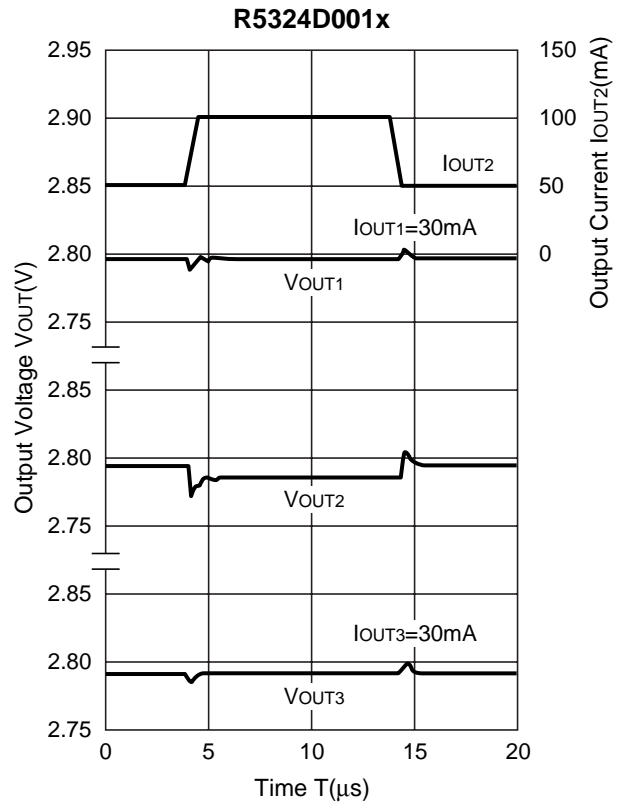
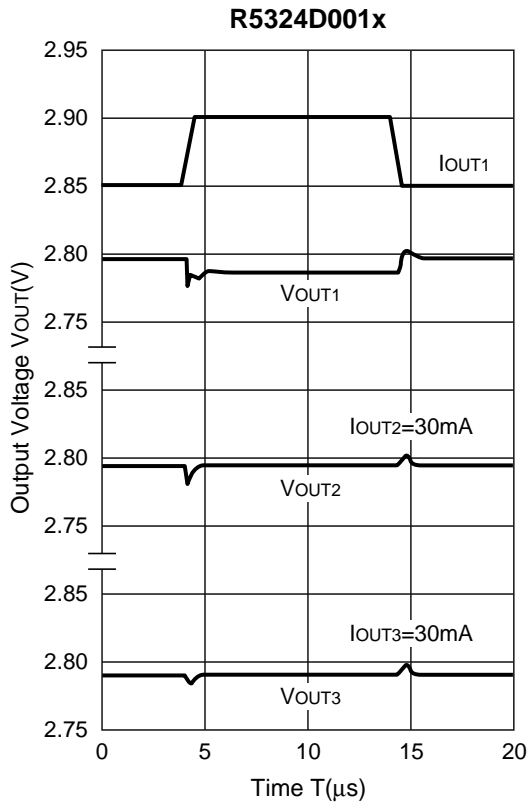

R5324x

ESR vs. Output Current

When using these ICs, consider the following points:

The relations between I_{OUT} (Output Current) and ESR of an output capacitor are shown below.

The conditions when the white noise level is under $40\mu V$ (Avg.) are marked as the hatched area in the graph.

Measurement conditions

Frequency Band : 10Hz to 2MHz

Temperature : $-40^{\circ}C$ to $85^{\circ}C$

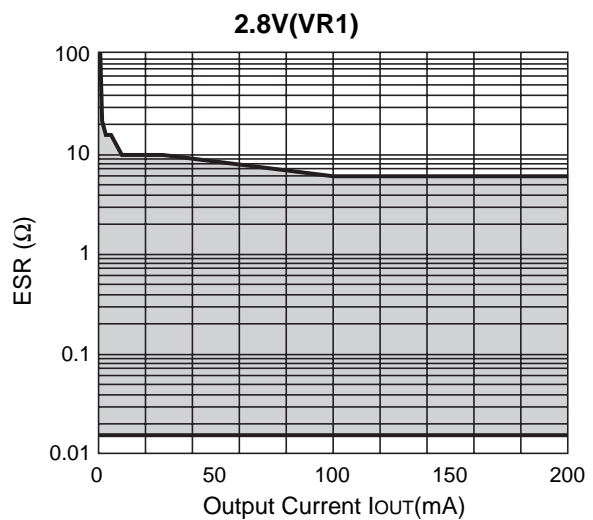
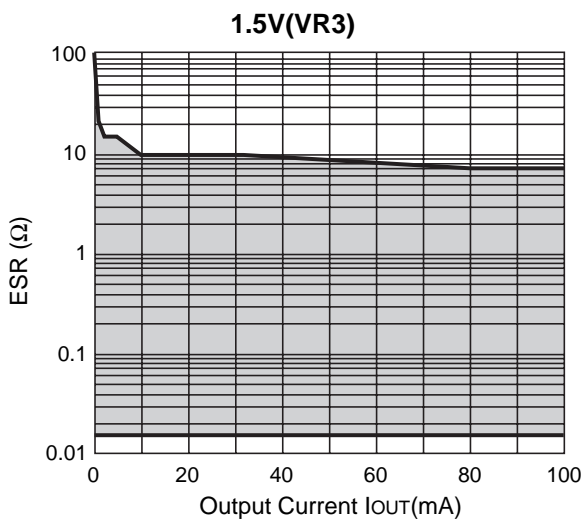
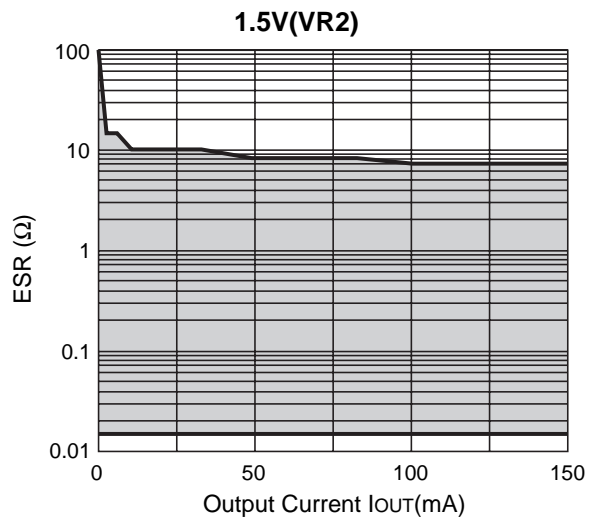
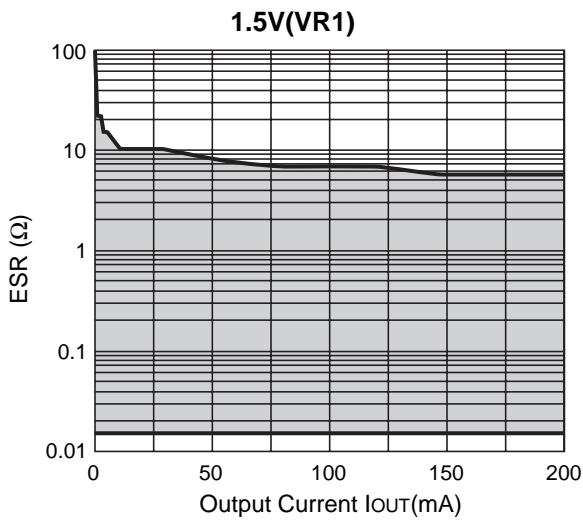

* R5324D (SON-8) is the discontinued product. As of March in 2015.

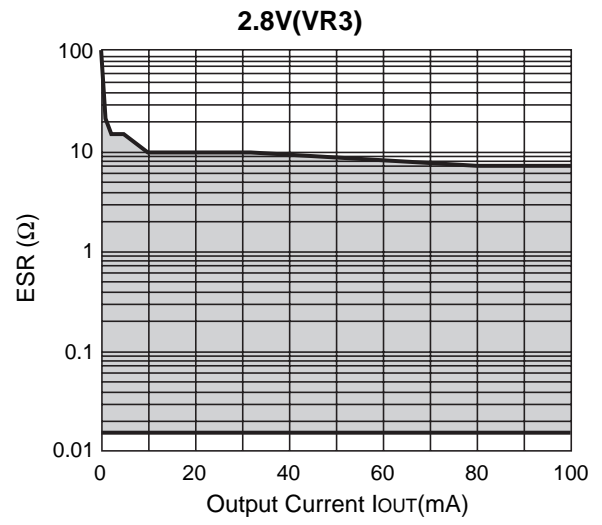
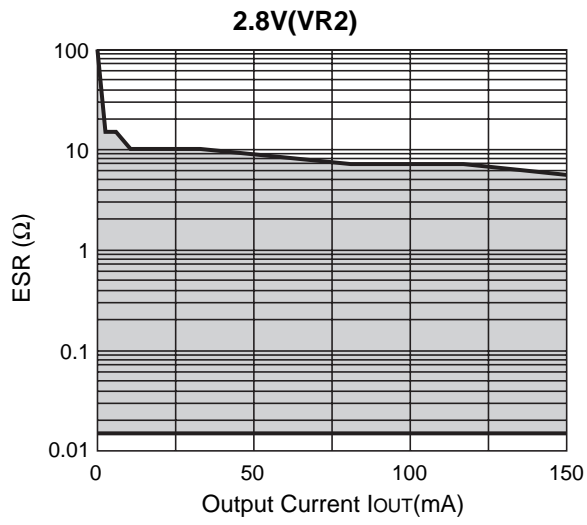



1. The products and the product specifications described in this document are subject to change or discontinuation of production without notice for reasons such as improvement. Therefore, before deciding to use the products, please refer to our sales representatives for the latest information thereon.
2. The materials in this document may not be copied or otherwise reproduced in whole or in part without prior written consent of our company.
3. Please be sure to take any necessary formalities under relevant laws or regulations before exporting or otherwise taking out of your country the products or the technical information described herein.
4. The technical information described in this document shows typical characteristics of and example application circuits for the products. The release of such information is not to be construed as a warranty of or a grant of license under our company's or any third party's intellectual property rights or any other rights.
5. The products listed in this document are intended and designed for use as general electronic components in standard applications (office equipment, telecommunication equipment, measuring instruments, consumer electronic products, amusement equipment etc.). Those customers intending to use a product in an application requiring extreme quality and reliability, for example, in a highly specific application where the failure or misoperation of the product could result in human injury or death (aircraft, spacevehicle, nuclear reactor control system, traffic control system, automotive and transportation equipment, combustion equipment, safety devices, life support system etc.) should first contact us.
6. We are making our continuous effort to improve the quality and reliability of our products, but semiconductor products are likely to fail with certain probability. In order to prevent any injury to persons or damages to property resulting from such failure, customers should be careful enough to incorporate safety measures in their design, such as redundancy feature, fire containment feature and fail-safe feature. We do not assume any liability or responsibility for any loss or damage arising from misuse or inappropriate use of the products.
7. Anti-radiation design is not implemented in the products described in this document.
8. The X-ray exposure can influence functions and characteristics of the products. Confirm the product functions and characteristics in the evaluation stage.
9. WLCSP products should be used in light shielded environments. The light exposure can influence functions and characteristics of the products under operation or storage.
10. There can be variation in the marking when different AOI (Automated Optical Inspection) equipment is used. In the case of recognizing the marking characteristic with AOI, please contact our sales or our distributor before attempting to use AOI.
11. Please contact our sales representatives should you have any questions or comments concerning the products or the technical information.



Nisshinbo Micro Devices Inc.

Official website

<https://www.nisshinbo-microdevices.co.jp/en/>

Purchase information

<https://www.nisshinbo-microdevices.co.jp/en/buy/>

