

THIS DOCUMENT IS THE PROPERTY OF
KEYSTONE ELECTRONICS CORP. AND
SHALL NOT BE REPRODUCED, DISTRIBUTED
OR USED AS A BASIS FOR MANUFACTURE
WITHOUT PRIOR WRITTEN PERMISSION
FROM KEYSTONE ELECTRONICS CORP.

ACTUAL SIZE

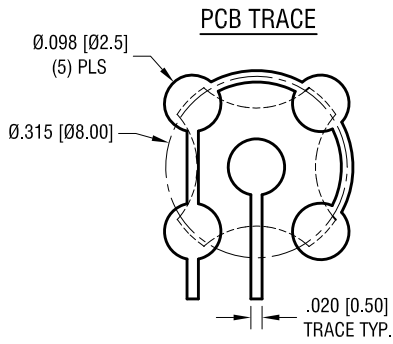

KEYPAD DOMES ARE DESIGNED
TO BE PLACED ON PCB, NOT SOLDERED

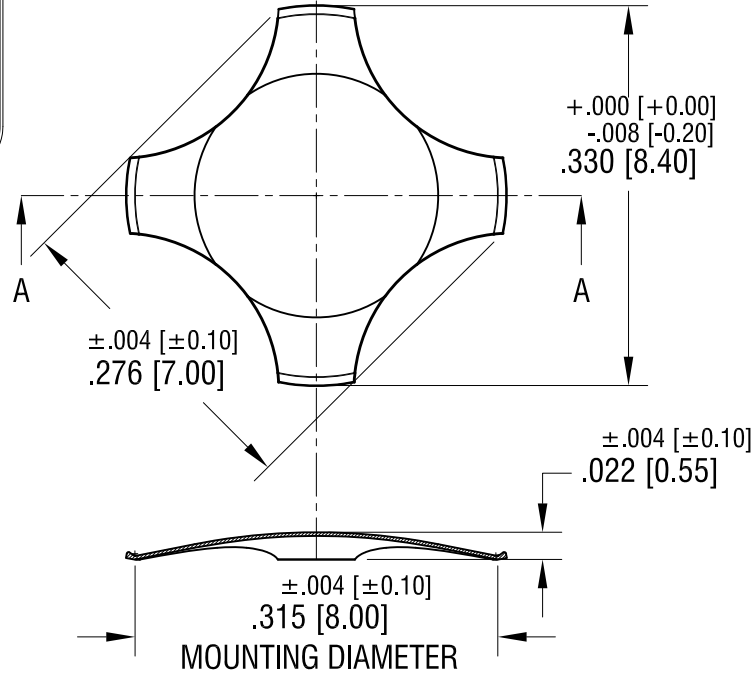

SECTION A-A

NOTE:

1. VOLTAGE/CURRENT MAXIMUM: 12mA@ 24 Volts DC
2. OPERATING TEMPERATURE: -40°F [-40°C] TO 220°F [105°C]
3. STORAGE TEMPERATURE: -65°F [-55°C] TO 250°F [125°C]
4. TRIP FORCE: 340g

KEYSTONE ELECTRONICS CORP.

www.keyelco.com • NEW HYDE PARK NY 11040 • Tel (516)328-7500

PART NAME

MINI 4 LEG DOME

MATERIAL

.003 [0.08] TH'K STAINLESS STEEL

FINISH

NICKEL PLATE

DRN BY

NT

DATE

2.15.17

APP'D

RH

SCALE

5X

TOLERANCES

INCH [MM]

DECIMAL ±.005 [±0.13]

ANGULAR ± 1°
UNLESS OTHERWISE SPECIFIED

CODE

C

DWG NO.

5135

6.09.22 SUPPLIED IN BULK WAS SUPPLIED
IN TUBE
CHANGE AS PER ECN 22-086

A

REV.

DATE

DESCRIPTION