

ASA 6W-M Series

6 Watts

DC/DC Converter

Total Power: 6 Watts
Input Voltage: 9 to 18 Vdc
18 to 36 Vdc
36 to 75Vdc
of Outputs: Single /Dual

Special Features

- Reinforced Insulation rated for 300Vac Working Voltage
- I/O-isolation Voltage 4000Vac
- Industrial & Medical Safety Approval
- Wide 2:1 Input Voltage Range
- Fully regulated Output Voltage
- Low Leakage Current
- Operating Temp Range -40 °C to +75 °C
- Input Filter meets EN55022, class A
- Overload Protection
- 3 Years Product Warranty

Safety

cUL/UL 60950-1
CSA C22.2 No.60950-1-03
UL60601-1,CSA C22.2 No.601-1
IEC/EN 60950-1, IEC/EN 60601-1

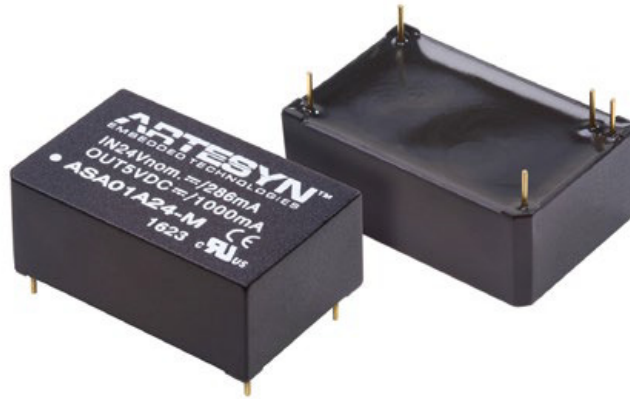

Product Descriptions

The ASA 6W-M series are single and dual output DC/DC converter modules. The ASA 6W-M series DC/DC converters offer an economical solution for demanding applications in industrial and medical instrumentation requesting a certified high supplementary or reinforced insulation system to comply with relative industrial or medical safety standards. All models feature ultra-wide 2:1 input range with excellent output voltage regulation. The ASA 6W-M series can deliver up to 6W output power from the single or dual output module with high 80% typical efficiency and excellent thermal performance over an operating ambient temperature range of -40 °C ~ +75 °C.

The ASA 6W-M series is a range of high performance DC/DC converter modules with a reinforced insulation system. The I/O- isolation voltage is specified for 4000Vac, The product comes in a small DIP-24 package.

Model Numbers

Model	Input Voltage	Output Voltage	Maximum Load	Efficiency
ASA01A12-M	9-18Vdc	5V	1A	75%
ASA001B12-M	9-18Vdc	12V	0.5A	78%
ASA01BB12-M	9-18Vdc	± 12V	±0.25A	78%
ASA01CC12-M	9-18Vdc	± 15V	±0.2A	78%
ASA01A24-M	18-36Vdc	5V	1A	77%
ASA01B24-M	18-36Vdc	12V	0.5A	80%
ASA01BB24-M	18-36Vdc	± 12V	±0.25 A	80%
ASA01CC24-M	18-36Vdc	± 15 V	±0.2 A	80%
ASA01A48-M	36-75 Vdc	5V	1A	77%
ASA01B48-M	36-75 Vdc	12V	0.5A	80%
ASA01BB48-M	36-75 Vdc	± 12V	±0.25A	80%
ASA01CC48-M	36-75 Vdc	± 15V	±0.2A	80%

Electrical Specifications

Absolute Maximum Ratings

Stress in excess of those listed in the “Absolute Maximum Ratings” may cause permanent damage to the power supply. These are stress ratings only and functional operation of the unit is not implied at these or any other conditions above those given in the operational sections of this TRN. Exposure to any absolute maximum rated condition for extended periods may adversely affect the power supply’s reliability.

Table 1. Absolute Maximum Ratings:

Parameter	Model	Symbol	Min	Typ	Max	Unit
Input Voltage Operating -Continuous	12V input Models	$V_{IN,DC}$	9	-	18	Vdc
	24V input Models		18	-	36	
	48V input Models		36	-	75	
Maximum Output Power	All models	$P_{O,max}$	-	-	6	W
Isolation Voltage Input to output	All models		4000	-	-	Vac
Isolation Resistance 500Vdc	All models		10	-	-	Gohm
Isolation Capacitance 100KHz, 1V	All models		-	7	13	pF
Operating Ambient Temperature With Derating Without Derating	All models	T_A	-40	-	+75	°C
	All models		-40	-	+55	°C
Operating Case Temperature	All models	T_{CASE}	-40	-	+95	°C
Storage Temperature	All models	T_{STG}	-50	-	+125	°C
Humidity (non-condensing) Operating Non-operating	All models		-	-	95	%
	All models		-	-	95	%

Input Specifications

Table 2. Input Specifications:

Parameter		Condition	Symbol	Min	Nom	Max	Unit
Operating Input Voltage, DC	12V input Models	All	$V_{IN,DC}$	9	-	18	Vdc
	24V input Models			18	-	36	
	48V input Models			36	-	75	
Input Surge Voltage	12V input Models	1 sec, max	$V_{IN,surge}$	-0.7	-	25	Vdc
	24V input Models			-0.7	-	50	
	48V input Models			-0.7	-	100	
Start-up Threshold Voltage	12V input Models	All	$V_{IN,ON}$	7	8	9	Vdc
	24V Input Models			13	15	18	
	48V Input Models			30	33	36	
Under Voltage Shutdown	12V input Models	All	$V_{IN,OFF}$	-	-	8.5	Vdc
	24V Input Models			-	-	16	
	48V Input Models			-	-	34	
Input reflected ripple current	12V input Models	20MHz, Measure with a inductor 4.7 μ H and Capacitance 220uF	$I_{IN,ripple}$	-	60	-	mA
	24V Input Models			-	30	-	
	48V Input Models			-	15	-	
Input Current	ASA01A12-M	$V_{IN,DC}=V_{IN,nom}$	$I_{IN,full\ load}$	-	570	-	mA
	ASA001B12-M			-	641	-	
	ASA01BB12-M			-	641	-	
	ASA01CC12-M			-	641	-	
	ASA01A24-M			-	278	-	
	ASA01B24-M			-	313	-	
	ASA01BB24-M			-	313	-	
	ASA01CC24-M			-	313	-	
	ASA01A48-M			-	139	-	
	ASA01B48-M			-	156	-	
ASA01BB48-M	-	156	-				
ASA01CC48-M	-	156	-				
No Load Input Current ($V_O=On, I_O=0A$)	ASA01A12-M	$V_{IN,DC}=V_{IN,nom}$	$I_{IN,no-load}$	-	30	-	mA
	ASA001B12-M			-	30	-	
	ASA01BB12-M			-	30	-	
	ASA01CC12-M			-	30	-	
	ASA01A24-M			-	20	-	
	ASA01B24-M			-	20	-	
	ASA01BB24-M			-	20	-	
	ASA01CC24-M			-	20	-	
	ASA01A48-M			-	10	-	
	ASA01B48-M			-	10	-	
ASA01BB48-M	-	10	-				
ASA01CC48-M	-	10	-				

Input Specifications

Table 2. Input Specifications con't:

Parameter		Condition	Symbol	Min	Nom	Max	Unit
Efficiency	ASA01A12-M	$V_{IN,DC} = V_{IN,nom}$ $I_O = I_{O,max}$ $T_A = 25\text{ }^{\circ}\text{C}$	η	-	75	-	%
	ASA001B12-M			-	78	-	
	ASA01BB12-M			-	78	-	
	ASA01CC12-M			-	78	-	
	ASA01A24-M			-	77	-	
	ASA01B24-M			-	80	-	
	ASA01BB24-M			-	80	-	
	ASA01CC24-M			-	80	-	
	ASA01A48-M			-	77	-	
	ASA01B48-M			-	80	-	
	ASA01BB48-M			-	80	-	
ASA01CC48-M	-	80	-				
MTBF	MIL-STD-217F, $T_a = 25^{\circ}\text{C}$	All		1000	-	-	K Hours

Output Specifications

Table 3. Output Specifications:

Parameter		Condition	Symbol	Min	Nom	Max	Unit
Output Voltage Set-Point	ASA01A12-M	$V_{IN,DC}=V_{IN,nom}$ $I_O=I_{O,max}$ $T_A=25\text{ }^{\circ}\text{C}$	V_O	4.95	5	5.05	Vdc
	ASA001B12-M			11.88	12	12.12	
	ASA01BB12-M			± 11.88	± 12	± 12.12	
	ASA01CC12-M			± 14.85	± 15	± 15.15	
	ASA01A24-M			4.95	5	5.05	
	ASA01B24-M			11.88	12	12.12	
	ASA01BB24-M			± 11.88	± 12	± 12.12	
	ASA01CC24-M			± 14.85	± 15	± 15.15	
	ASA01A48-M			4.95	5	5.05	
	ASA01B48-M			11.88	12	12.12	
	ASA01BB48-M			± 11.88	± 12	± 12.12	
	ASA01CC48-M			± 14.85	± 15	± 15.15	
Output Current	ASA01A12-M	Convection cooling	I_O	-	-	1	A
	ASA001B12-M			-	-	0.5	
	ASA01BB12-M			-	-	0.25	
	ASA01CC12-M			-	-	0.2	
	ASA01A24-M			-	-	1	
	ASA01B24-M			-	-	0.5	
	ASA01BB24-M			-	-	0.25	
	ASA01CC24-M			-	-	0.2	
	ASA01A48-M			-	-	1	
	ASA01B48-M			-	-	0.5	
	ASA01BB48-M			-	-	0.25	
	ASA01CC48-M			-	-	0.2	
V_O Load Capacitance	ASA01A12-M	All		-	-	1000	uF
	ASA001B12-M			-	-	470	
	ASA01BB12-M			-	-	220#	
	ASA01CC12-M			-	-	220#	
	ASA01A24-M			-	-	1000	
	ASA01B24-M			-	-	470	
	ASA01BB24-M			-	-	220#	
	ASA01CC24-M			-	-	220#	
	ASA01A48-M			-	-	1000	
	ASA01B48-M			-	-	470	
	ASA01BB48-M			-	-	220#	
	ASA01CC48-M			-	-	220#	

Output Specifications

Table 3. Output Specifications con't:

Parameter	Condition	Symbol	Min	Nom	Max ¹	Unit
Output Ripple, pk-pk 5V Output Models Other Output Models	20MHz bandwidth, measured with a 1uF MLCC and a 10uF Tantalum Capacitor	V_O	-	75	100	mV
		V_o	-	100	150	mV
Line Regulation	$V_{IN,DC} = V_{IN,min}$ to $V_{IN,max}$	$\pm\%V_O$	-	0.3	0.5	%
Load Regulation	$I_O = 25\%I_{O,max}$ to $I_{O,max}$	$\pm\%V_O$	-	0.5	1.0	%
V_O Dynamic Response Peak Deviation Settling Time	25% load change, slew rate = 1A/uS	$\pm\%V_O$	-	3	6	%
		t_s	-	300	500	uSec
Temperature Coefficient	All	$\%/^{\circ}C$	-	0.02	0.05	%
Switching Frequency	All	f_{sw}	-	150	-	KHz
Output Over Current Protection	All		120	150	-	$\%I_{O,max}$
Output Short Circuit Protection	All		Continuous			

ASA01A12-M Performance Curves

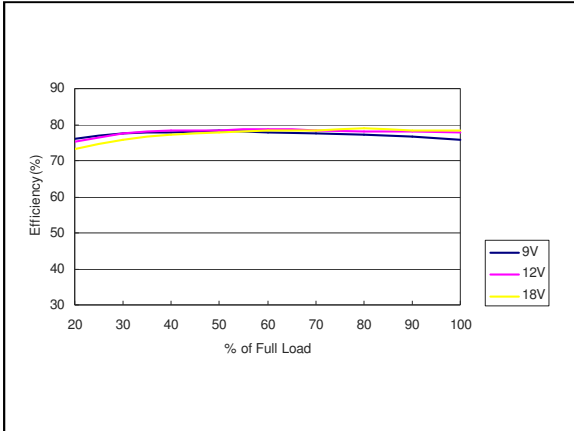

Figure 1: ASA01A12-M Efficiency Versus Output Current Curve
 Vin = 9 to 18Vdc Load: Io = 0 to 1A

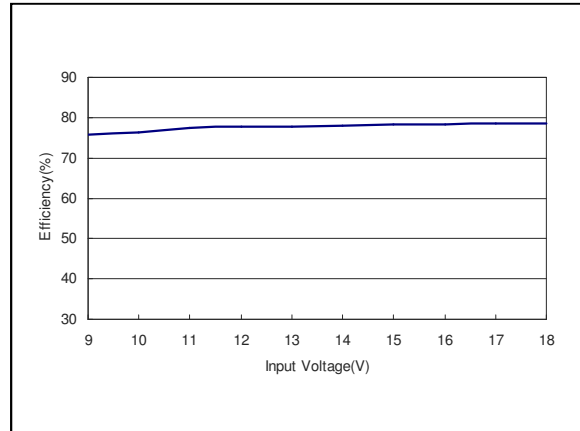

Figure 2: ASA01A12-M Efficiency Versus Input Voltage Curve
 Vin = 9 to 18Vdc Load: Io = 1A

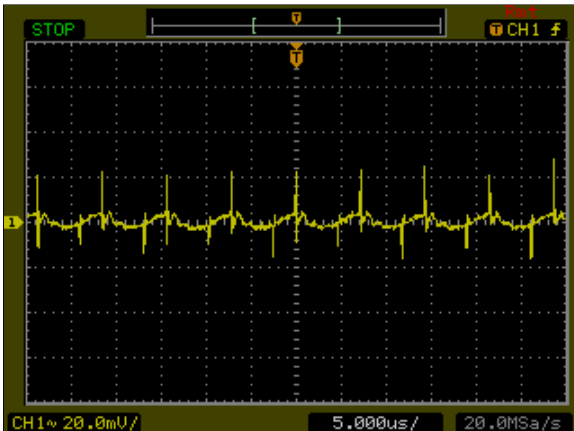

Figure 3: ASA01A12-M Ripple and Noise Measurement
 Vin = 12Vdc Load: Io = 1A
 Ch 1: Vo

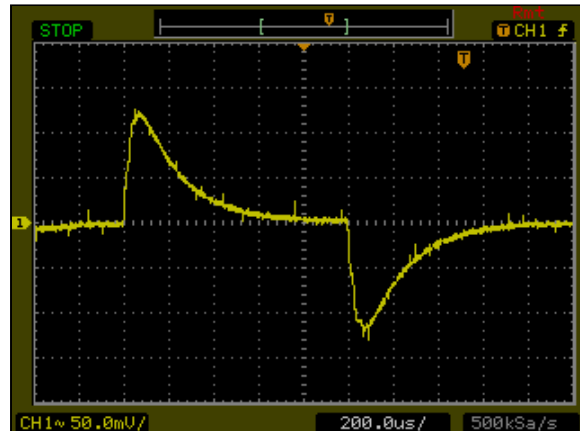

Figure 4: ASA01A12-M Transient Response
 Vin = 12Vdc Load: Io = 100% to 75% load change
 Ch 1: Vo

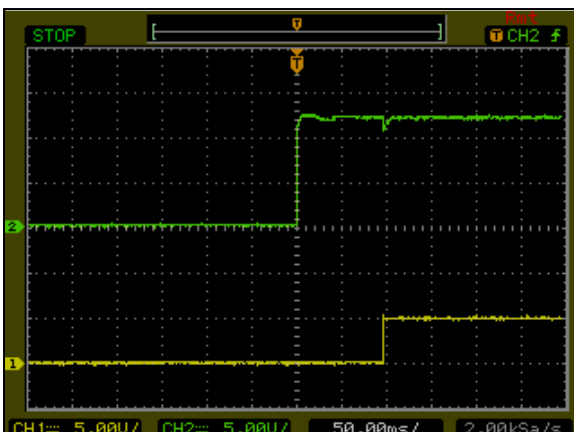

Figure 5: ASA01A12-M Output Voltage Startup Characteristic by Vin
 Vin = 12Vdc Load: Io = 1A
 Ch1: Vin Ch2: Vo

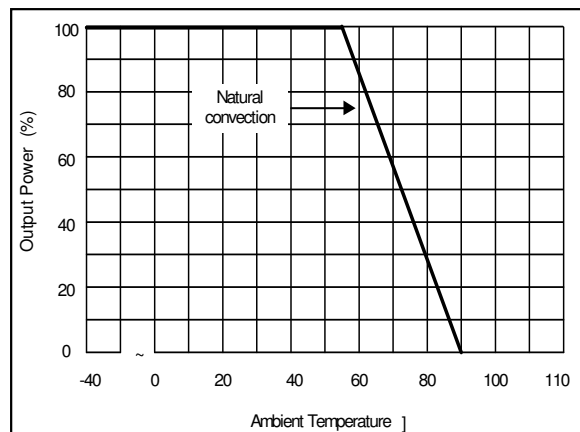

Figure 6: ASA01A12-M Output Current Versus Ambient Temperature
 Vin = 12Vdc Load: Io = 1A

ASA01A12-M Performance Curves

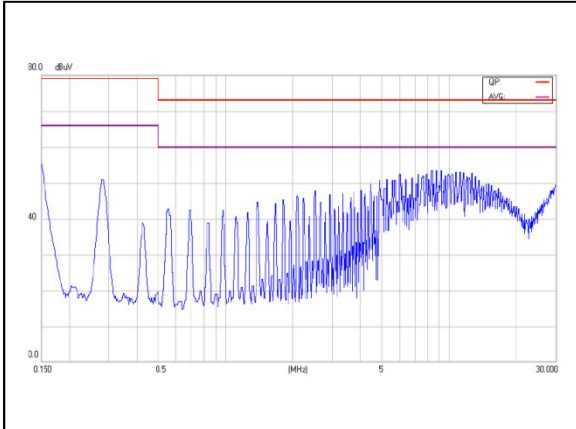

Figure 7: ASA01A12-M Conduction Emission of EN55022 Class A
Vin = 12Vdc Load: Io = 1A

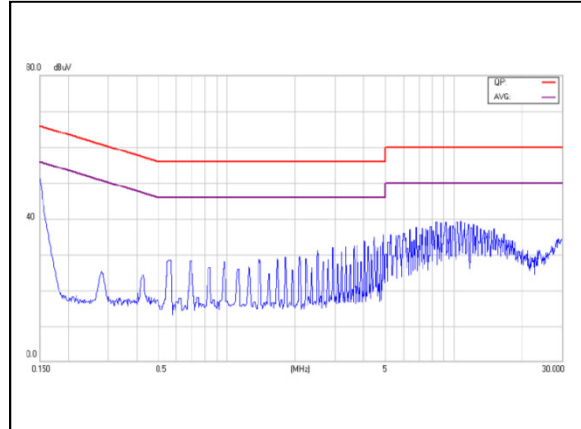

Figure 8: ASA01A12-M Conduction Emission of EN55022 Class B
Vin = 12Vdc Load: Io = 1A

Note - All test conditions are at 25 °C

ASA001B12-M Performance Curves

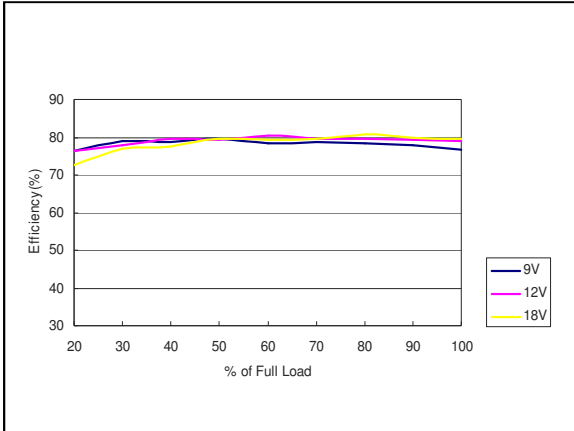

Figure 9: ASA001B12-M Efficiency Versus Output Current Curve
 Vin = 9 to 18Vdc Load: Io = 0 to 0.5A

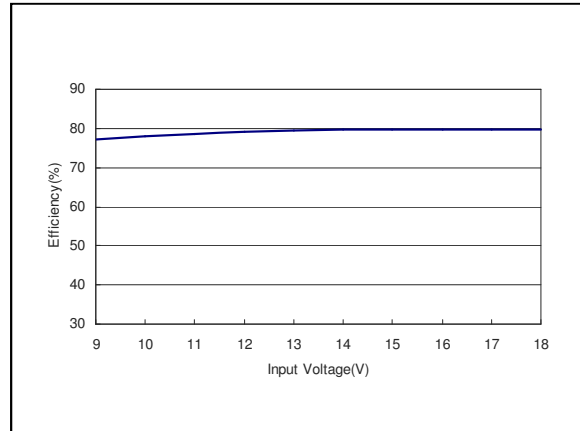

Figure 10: ASA001B12-M Efficiency Versus Input Voltage Curve
 Vin = 9 to 18Vdc Load: Io = 0.5A

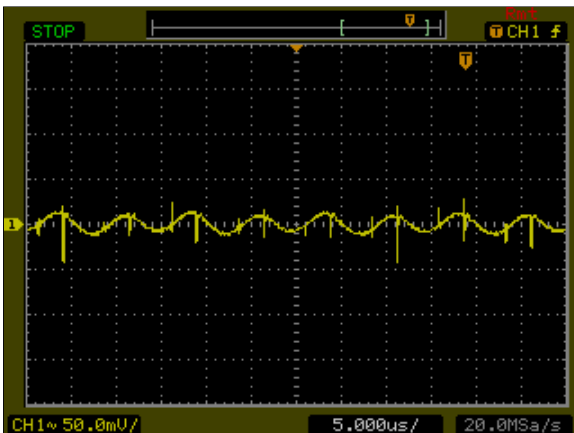

Figure 11: ASA001B12-M Ripple and Noise Measurement
 Vin = 12Vdc Load: Io = 0.5A
 Ch 1: Vo

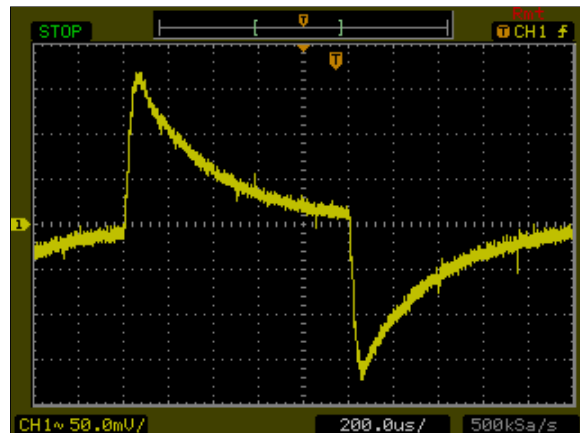

Figure 12: ASA001B12-M Transient Response
 Vin = 12Vdc Load: Io = 100% to 75% load change
 Ch 1: Vo

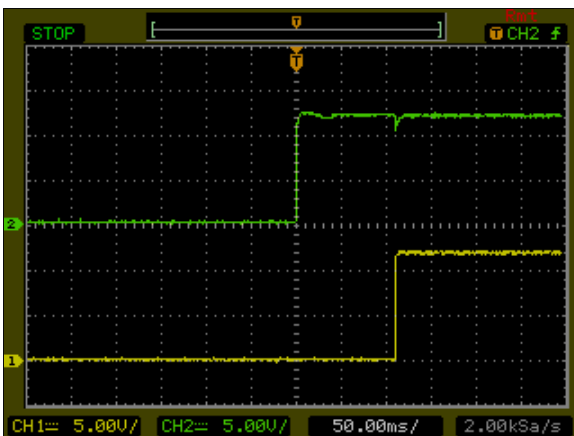

Figure 13: ASA001B12-M Output Voltage Startup Characteristic by Vin
 Vin = 12Vdc Load: Io = 0.5A
 Ch1: Vin Ch2: Vo

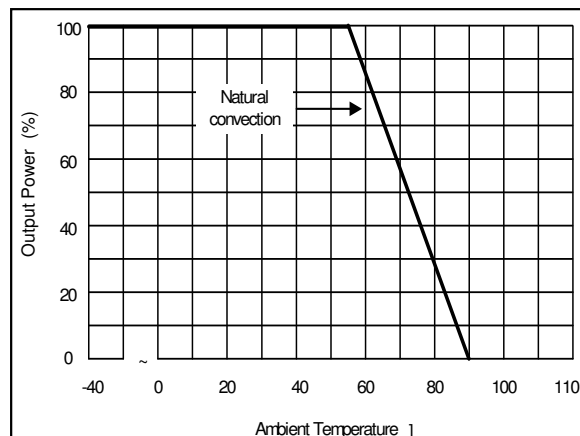

Figure 14: ASA001B12-M Output Current Versus Ambient Temperature
 Vin = 12Vdc Load: Io = 0.5A

ASA001B12-M Performance Curves

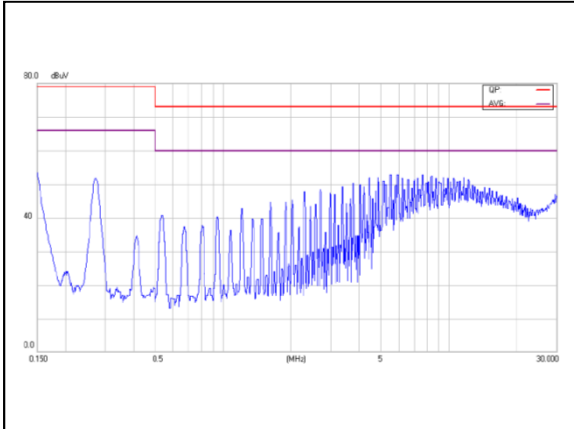

Figure 15: ASA001B12-M Conduction Emission of EN55022 Class A
Vin = 12Vdc Load: Io = 0.5A

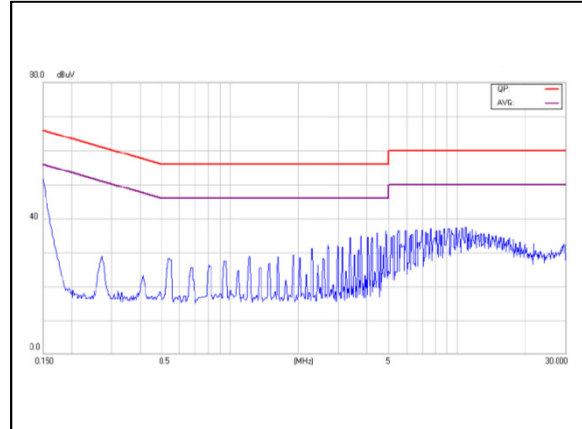

Figure 16: ASA001B12-M Conduction Emission of EN55022 Class B
Vin = 12Vdc Load: Io = 0.5A

Note - All test conditions are at 25 °C

ASA01BB12-M Performance Curves

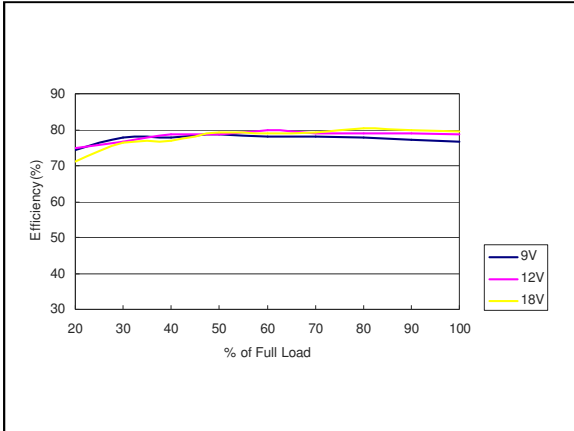

Figure 17: ASA01BB12-M Efficiency Versus Output Current Curve
 Vin = 9 to 18Vdc Load: Io = 0 to ± 0.25A

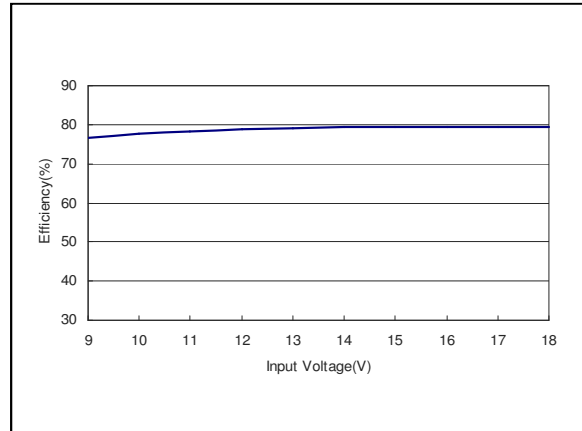

Figure 18: ASA01BB12-M Efficiency Versus Input Voltage Curve
 Vin = 9 to 18Vdc Load: Io = ± 0.25A

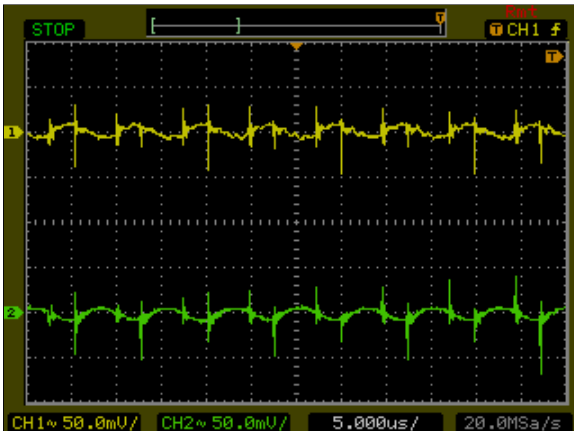

Figure 19: ASA01BB12-M Ripple and Noise Measurement
 Vin = 12Vdc Load: Io = ± 0.25A
 Ch 1: Vout1 Ch 2: Vout2

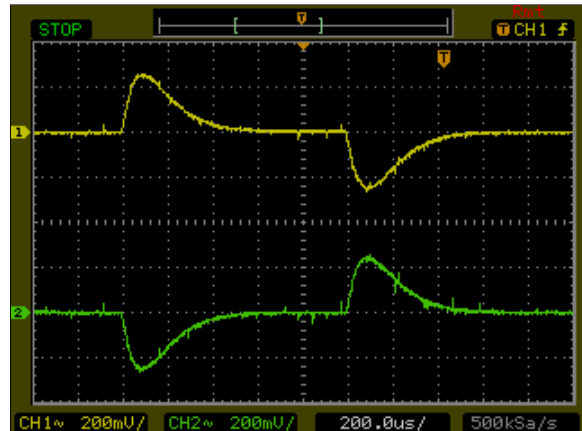

Figure 20: ASA01BB12-M Transient Response
 Vin = 12Vdc Load: Io = 100% to 75% load change
 Ch 1: Vout1 Ch 2: Vout2

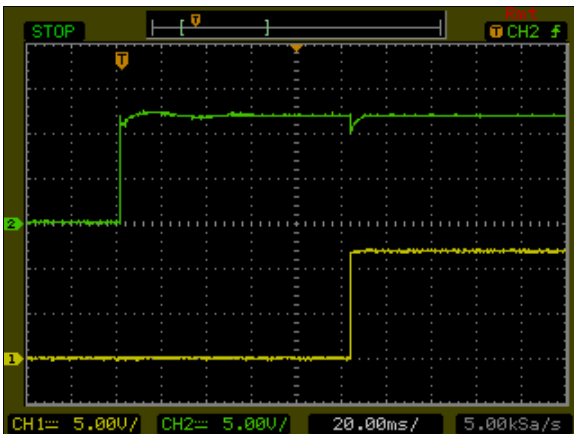

Figure 21: ASA01BB12-M Output Voltage Startup Characteristic by Vin
 Vin = 12Vdc Load: Io = ± 0.25A
 Ch1: Vin Ch2: Vo

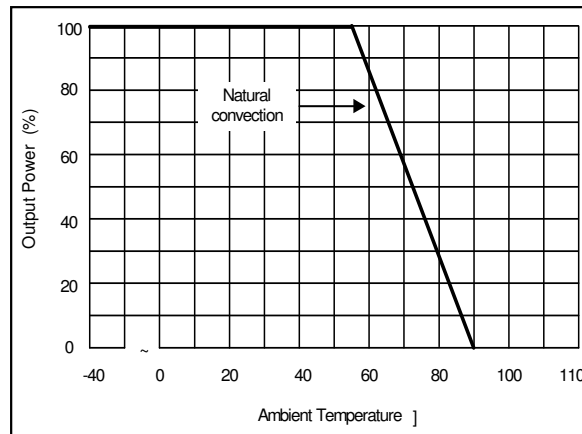

Figure 22: ASA01BB12-M Output Current Versus Ambient Temperature
 Vin = 12Vdc Load: Io = ± 0.25A

ASA01BB12-M Performance Curves

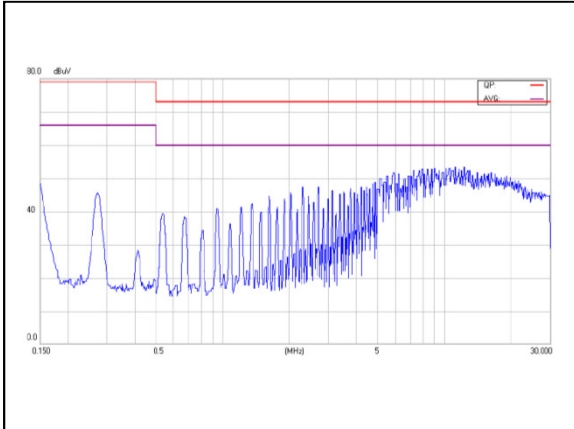

Figure 23: ASA01BB12-M Conduction Emission of EN55022 Class A
Vin = 12Vdc Load: $I_o = \pm 0.25A$

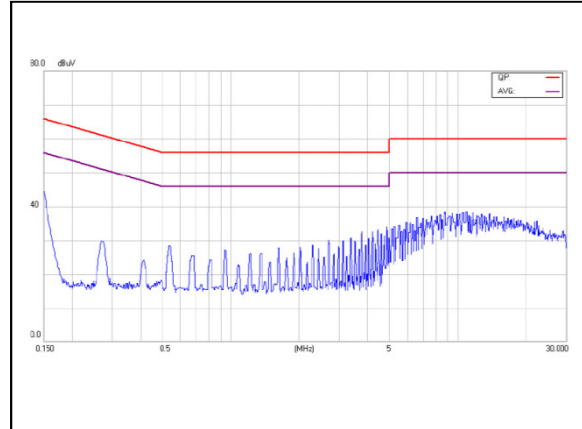

Figure 24: ASA01BB12-M Conduction Emission of EN55022 Class B
Vin = 12Vdc Load: $I_o = \pm 0.25A$

Note - All test conditions are at 25 °C

ASA01CC12-M Performance Curves

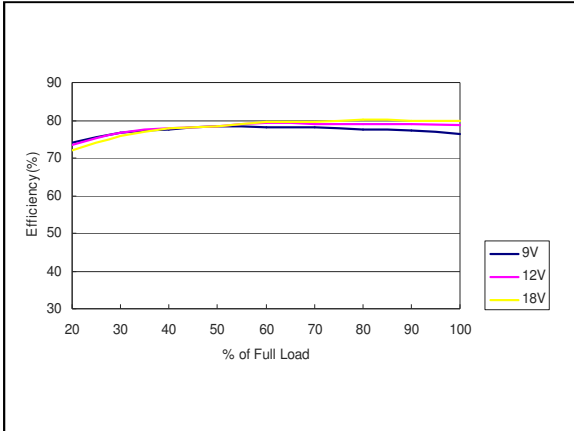

Figure 25: ASA01CC12-M Efficiency Versus Output Current Curve
 Vin = 9 to 18Vdc Load: Io = 0 to ± 0.2A

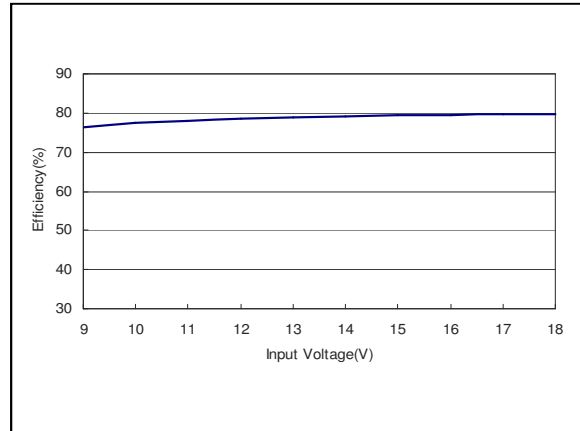

Figure 26: ASA01CC12-M Efficiency Versus Input Voltage Curve
 Vin = 9 to 18Vdc Load: Io = ± 0.2A

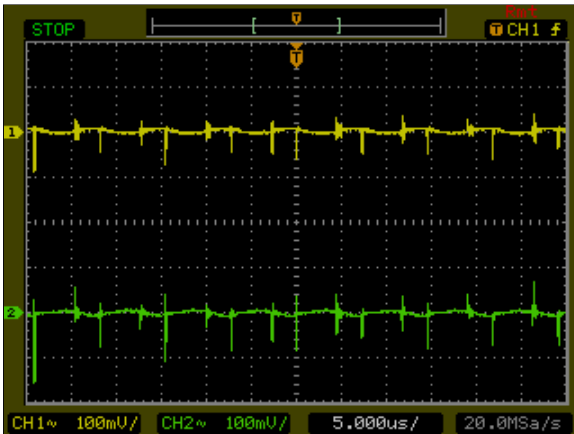

Figure 27: ASA01CC12-M Ripple and Noise Measurement
 Vin = 12Vdc Load: Io = ± 0.2A
 Ch 1: Vout1 Ch 2: Vout2

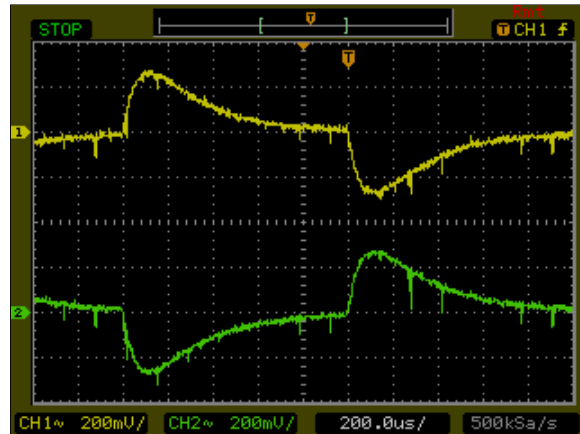

Figure 28: ASA01CC12-M Transient Response
 Vin = 12Vdc Load: Io = 100% to 75% load change
 Ch 1: Vout1 Ch 2: Vout2

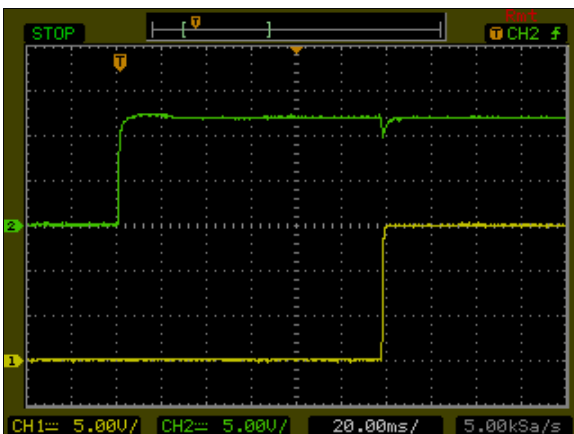

Figure 29: ASA01CC12-M Output Voltage Startup Characteristic by Vin
 Vin = 12Vdc Load: Io = ± 0.2A
 Ch1: Vin Ch2: Vo

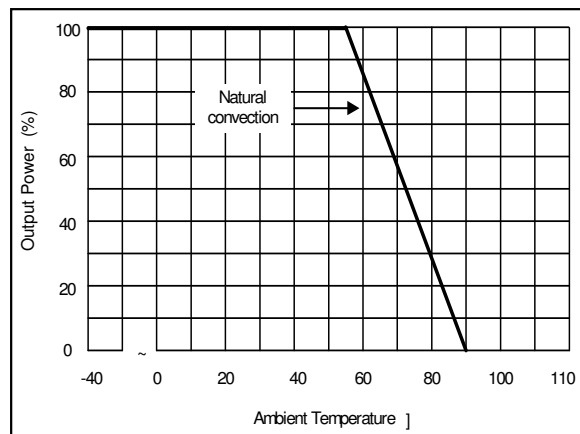

Figure 30: ASA01CC12-M Output Current Versus Ambient Temperature
 Vin = 12Vdc Load: Io = ± 0.2A

ASA01CC12-M Performance Curves

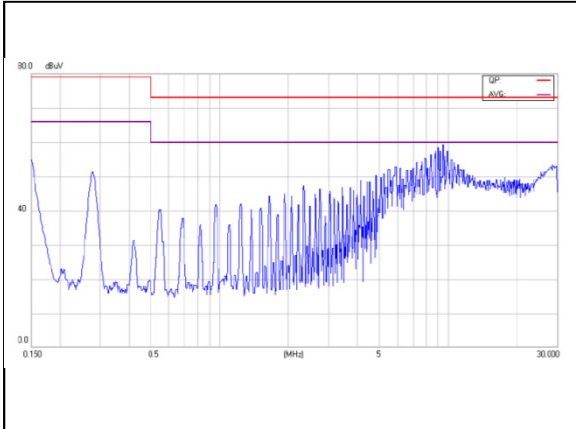

Figure 31: ASA01CC12-M Conduction Emission of EN55022 Class A
Vin = 12Vdc Load: Io = ± 0.2A

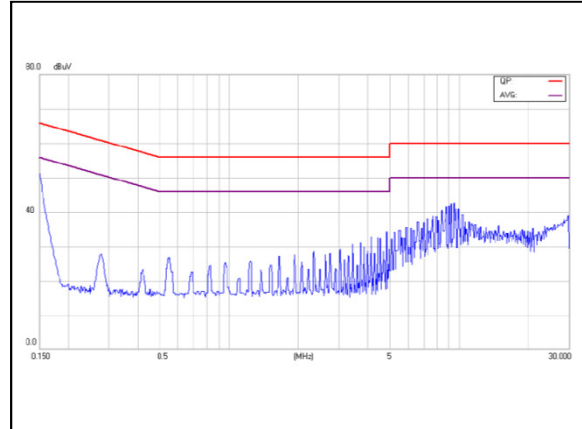

Figure 32: ASA01CC12-M Conduction Emission of EN55022 Class B
Vin = 12Vdc Load: Io = ± 0.2A

Note - All test conditions are at 25 °C

ASA01A24-M Performance Curves

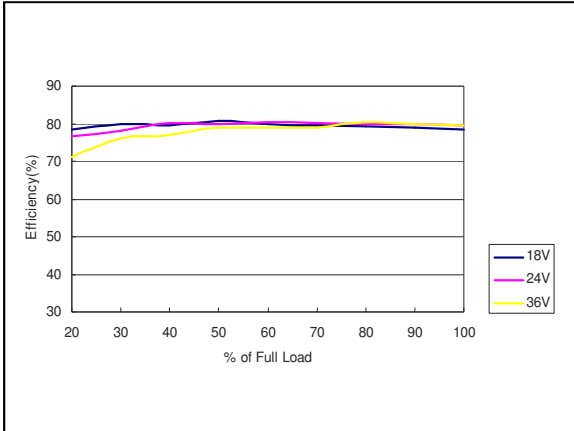

Figure 33: ASA01A24-M Efficiency Versus Output Current Curve
 Vin = 18 to 36Vdc Load: Io = 0 to 1A

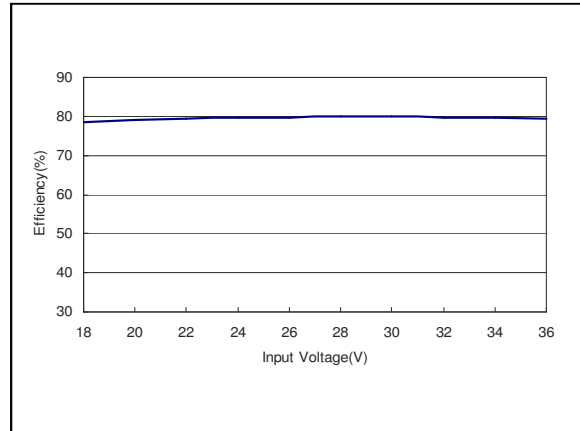

Figure 34: ASA01A24-M Efficiency Versus Input Voltage Curve
 Vin = 18 to 36Vdc Load: Io = 1A

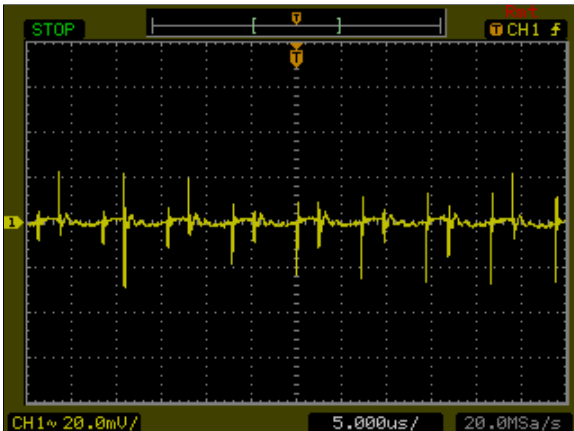

Figure 35: ASA01A24-M Ripple and Noise Measurement
 Vin = 24Vdc Load: Io = 1A
 Ch 1: Vo

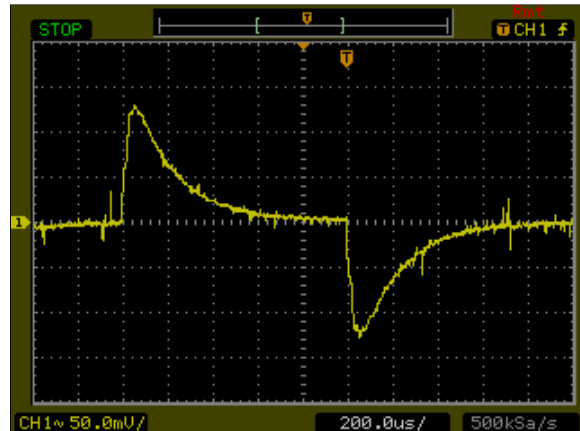

Figure 36: ASA01A24-M Transient Response
 Vin = 24Vdc Load: Io = 100% to 75% load change
 Ch 1: Vo

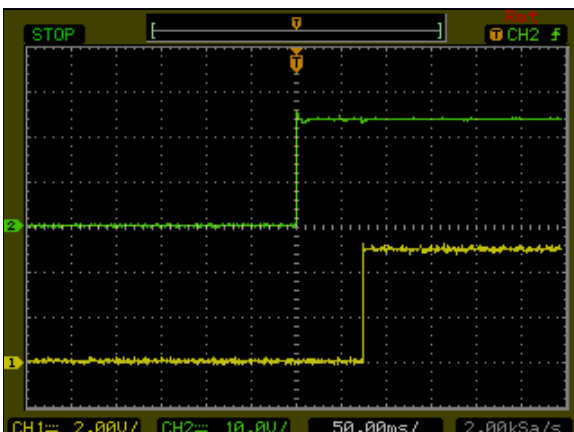

Figure 37: ASA01A24-M Output Voltage Startup Characteristic by Vin
 Vin = 24Vdc Load: Io = 1A
 Ch1: Vin Ch2: Vo

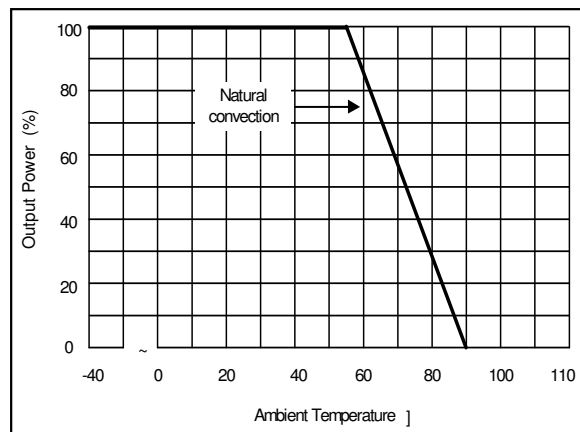

Figure 38: ASA01A24-M Output Current Versus Ambient Temperature
 Vin = 24Vdc Load: Io = 1A

ASA01A24-M Performance Curves

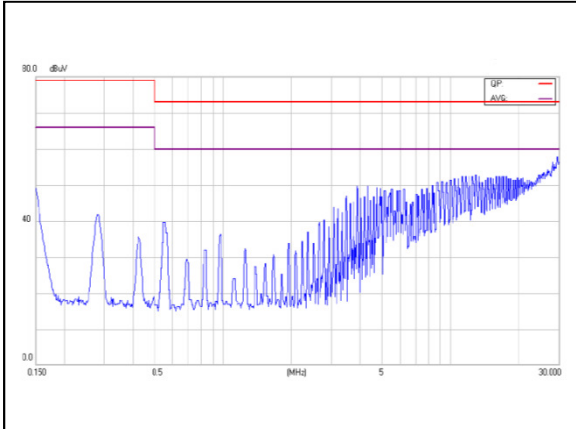

Figure 39: ASA01A24-M Conduction Emission of EN55022 Class A
Vin = 24Vdc Load: Io = 1A

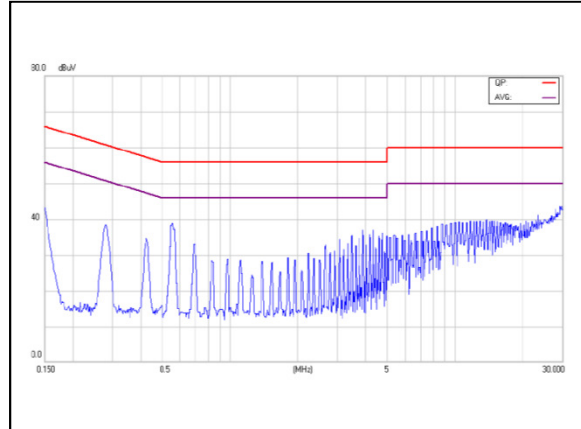

Figure 40: ASA01A24-M Conduction Emission of EN55022 Class B
Vin = 24Vdc Load: Io = 1A

Note - All test conditions are at 25 °C

ASA01B24-M Performance Curves

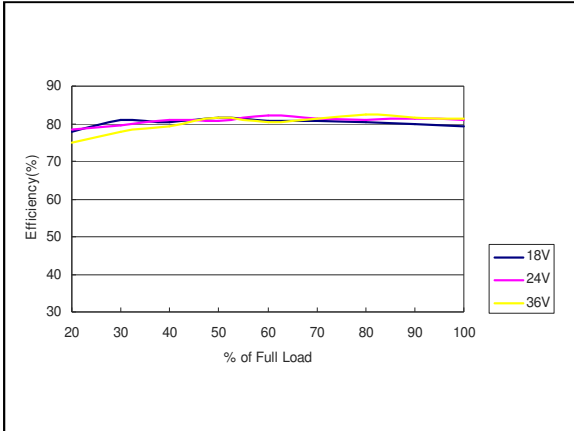

Figure 41: ASA01B24-M Efficiency Versus Output Current Curve
 Vin = 18 to 36Vdc Load: Io = 0 to 0.5A

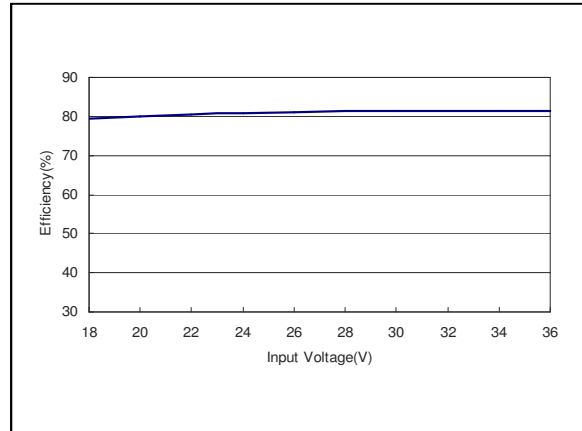

Figure 42: ASA01B24-M Efficiency Versus Input Voltage Curve
 Vin = 18 to 36Vdc Load: Io = 0.5A

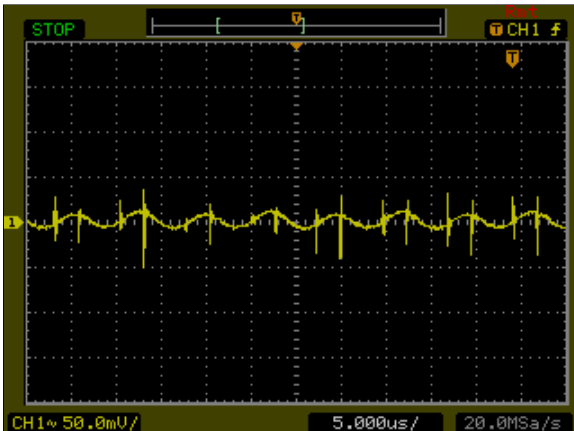

Figure 43: ASA01B24-M Ripple and Noise Measurement
 Vin = 24Vdc Load: Io = 0.5A
 Ch 1: Vo

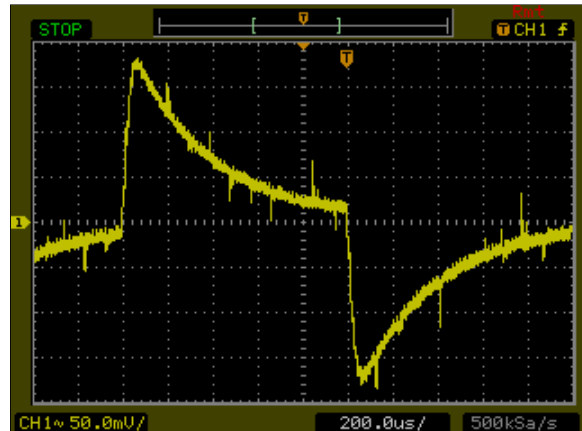

Figure 44: ASA01B24-M Transient Response
 Vin = 24Vdc Load: Io = 100% to 75% load change
 Ch 1: Vo

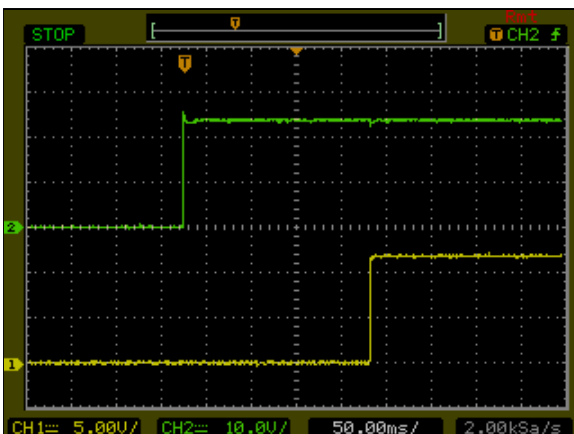

Figure 45: ASA01B24-M Output Voltage Startup Characteristic by Vin
 Vin = 24Vdc Load: Io = 0.5A
 Ch1: Vin Ch2: Vo

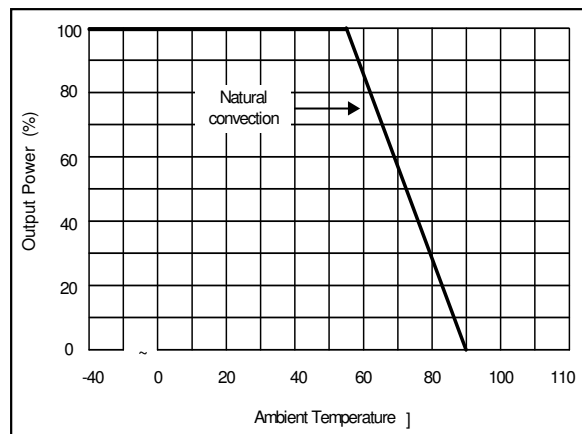

Figure 46: ASA01B24-M Output Current Versus Ambient Temperature
 Vin = 24Vdc Load: Io = 0.5A

ASA01B24-M Performance Curves

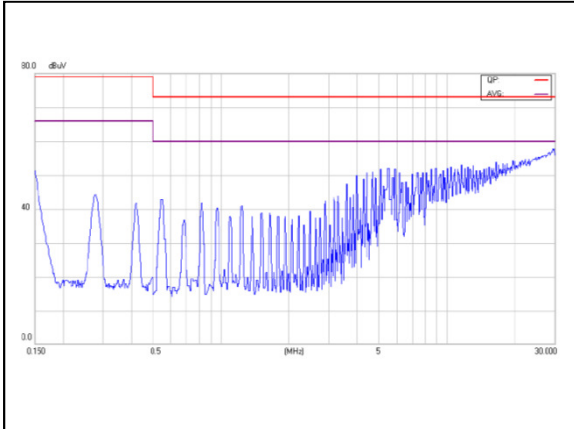

Figure 47: ASA01B24-M Conduction Emission of EN55022 Class A
Vin = 24Vdc Load: Io = 0.5A

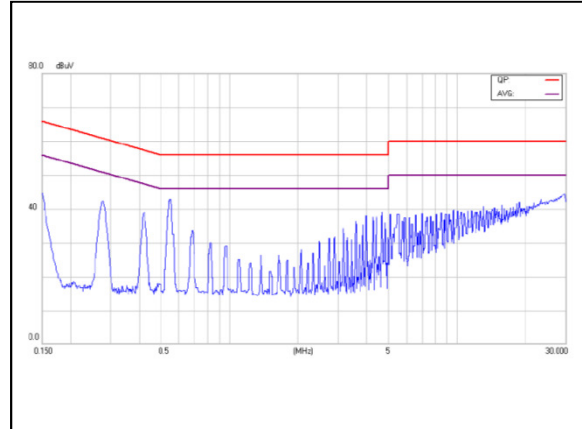

Figure 48: ASA01B24-M Conduction Emission of EN55022 Class B
Vin = 24Vdc Load: Io = 0.5A

Note - All test conditions are at 25 °C

ASA01BB24-M Performance Curves

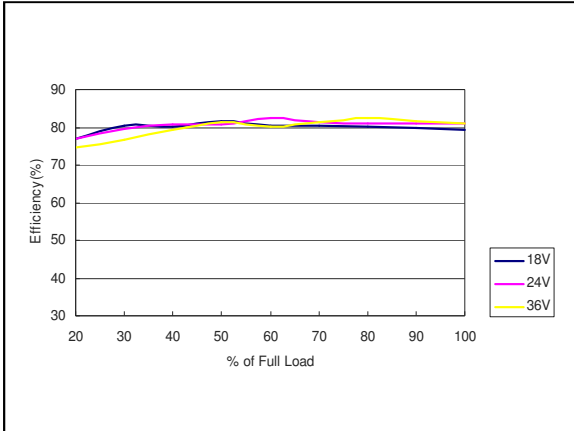

Figure 49: ASA01BB24-M Efficiency Versus Output Current Curve
 Vin = 18 to 36Vdc Load: Io = 0 to ± 0.25A

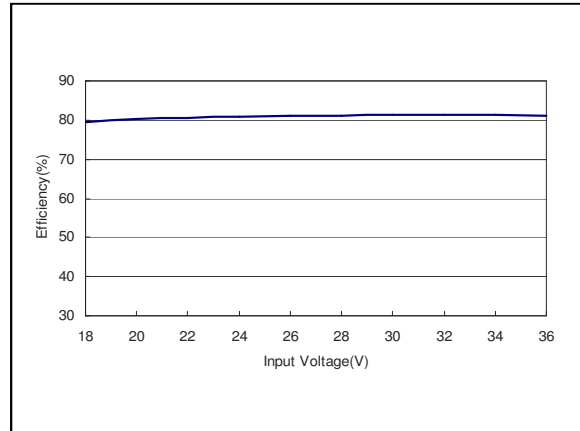

Figure 50: ASA01BB24-M Efficiency Versus Input Voltage Curve
 Vin = 18 to 36Vdc Load: Io = ± 0.25A

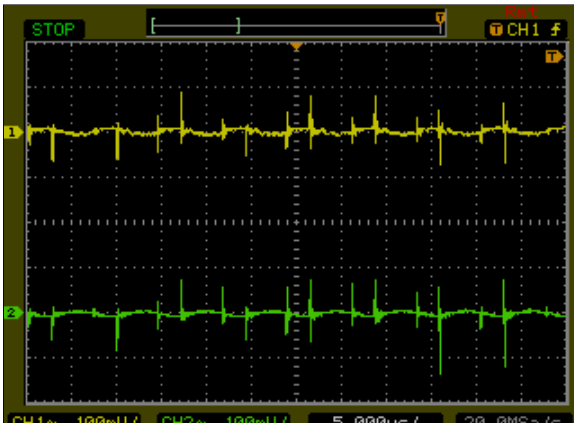

Figure 51: ASA01BB24-M Ripple and Noise Measurement
 Vin = 24Vdc Load: Io = ± 0.25A
 Ch 1: Vout1 Ch2: Vout2

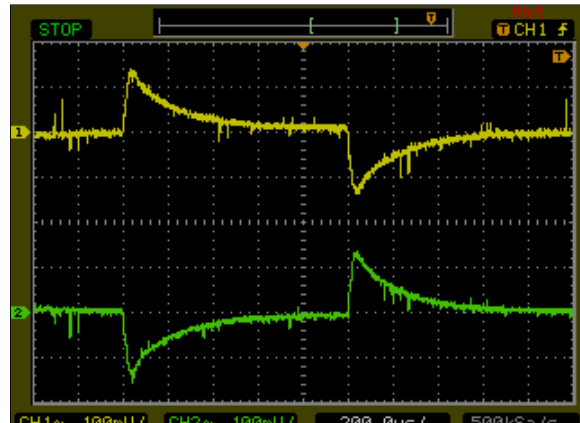

Figure 52: ASA01BB24-M Transient Response
 Vin = 24Vdc Load: Io = 100% to 75% load change
 Ch 1: Vout1 Ch2: Vout2

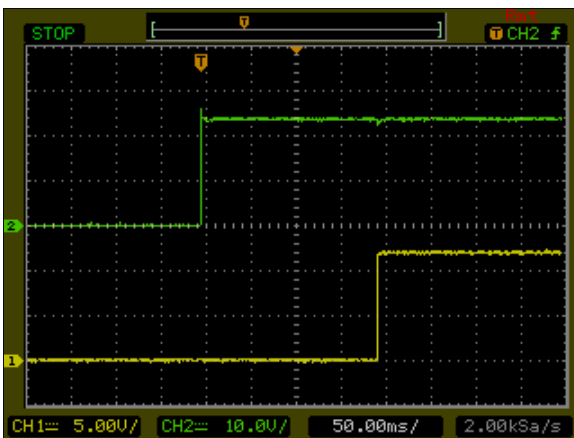

Figure 53: ASA01BB24-M Output Voltage Startup Characteristic by Vin
 Vin = 24Vdc Load: Io = ± 0.25A
 Ch1: Vin Ch2: Vo

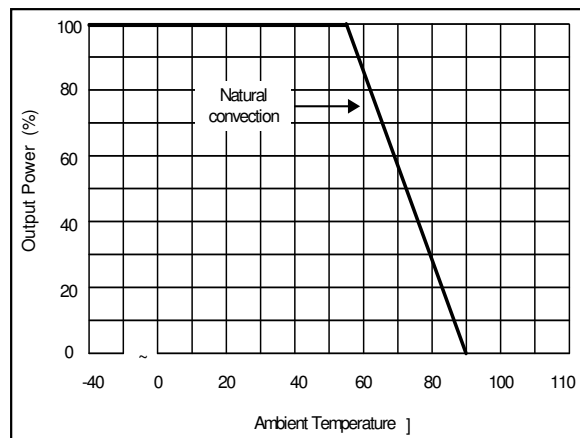

Figure 54: ASA01BB24-M Output Current Versus Ambient Temperature
 Vin = 24Vdc Load: Io = ± 0.25A

ASA01BB24-M Performance Curves

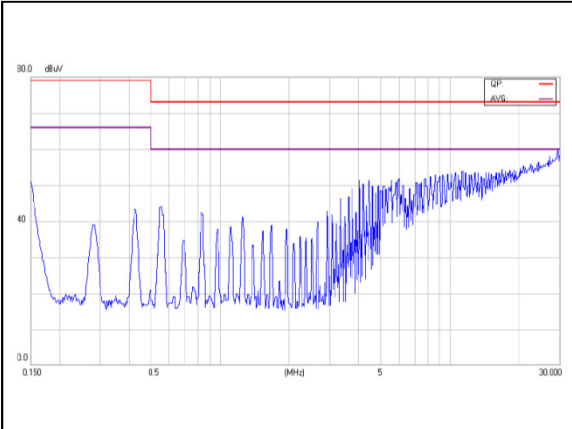

Figure 55: ASA01BB24-M Conduction Emission of EN55022 Class A
Vin = 24Vdc Load: $I_o = \pm 0.25A$

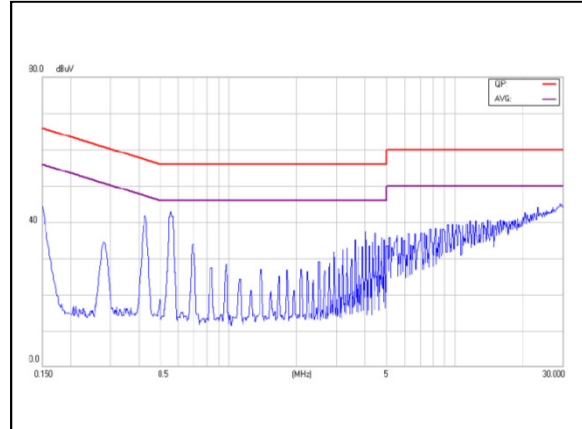

Figure 56: ASA01BB24-M Conduction Emission of EN55022 Class B
Vin = 24Vdc Load: $I_o = \pm 0.25A$

Note - All test conditions are at 25 °C

ASA01CC24-M Performance Curves

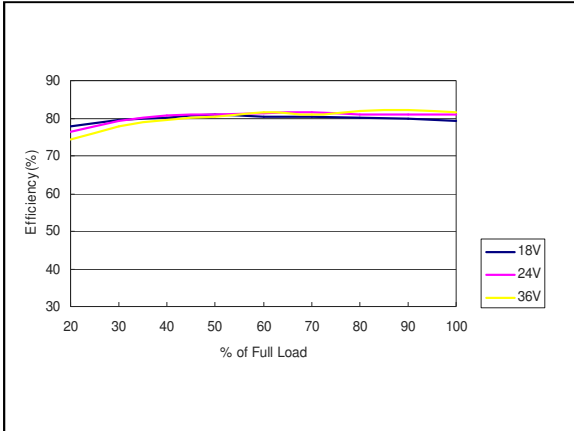

Figure 57: ASA01CC24-M Efficiency Versus Output Current Curve
 Vin = 18 to 36Vdc Load: Io = 0 to ± 0.2A

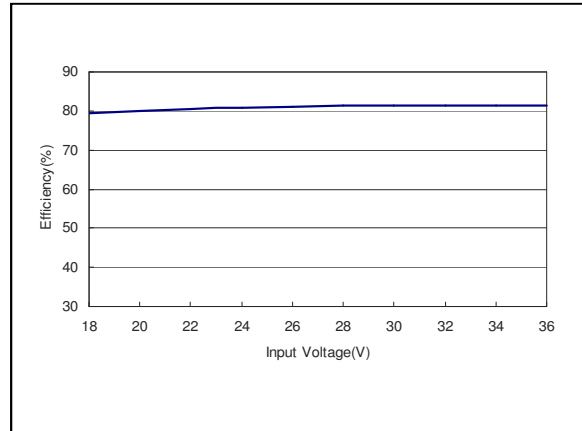

Figure 58: ASA01CC24-M Efficiency Versus Input Voltage Curve
 Vin = 18 to 36Vdc Load: Io = ± 0.2A

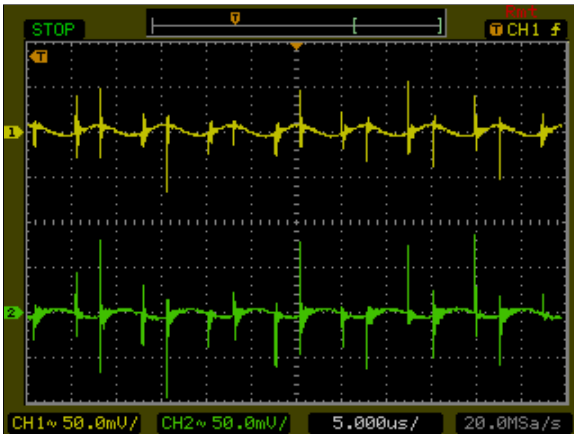

Figure 59: ASA01CC24-M Ripple and Noise Measurement
 Vin = 24Vdc Load: Io = ± 0.2A
 Ch 1: Vout1 Ch 2: Vout2

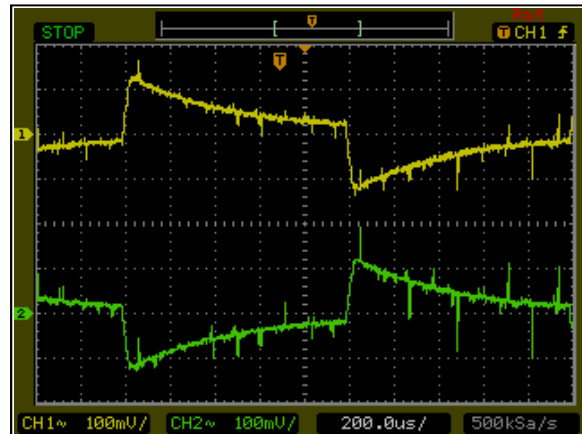

Figure 60: ASA01CC24-M Transient Response
 Vin = 24Vdc Load: Io = 100% to 75% load change
 Ch 1: Vout1 Ch 2: Vout2

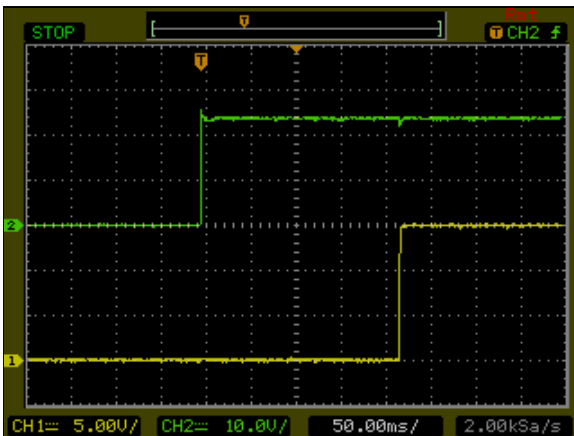

Figure 61: ASA01CC24-M Output Voltage Startup Characteristic by Vin
 Vin = 24Vdc Load: Io = ± 0.2A
 Ch1: Vin Ch2: Vo

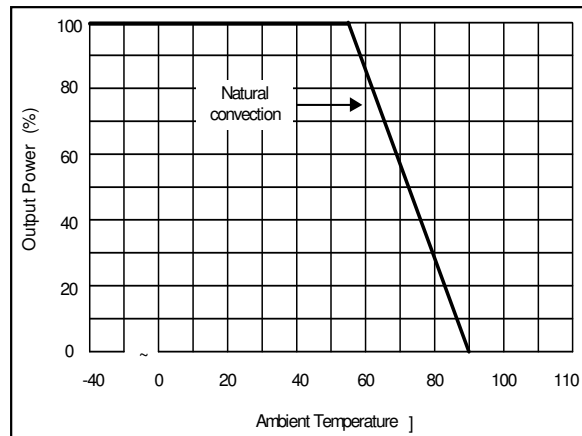

Figure 62: ASA01CC24-M Output Current Versus Ambient Temperature
 Vin = 24Vdc Load: Io = ± 0.2A

ASA01CC24-M Performance Curves

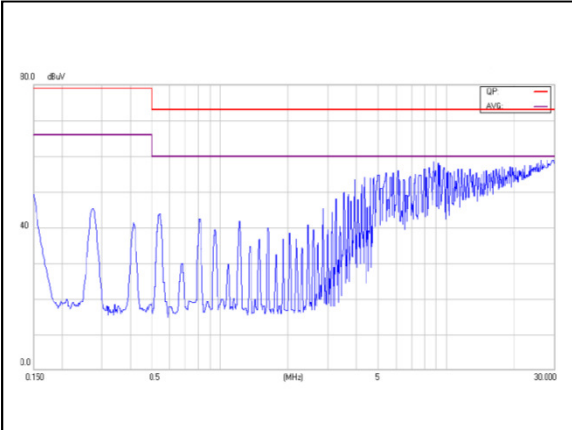

Figure 63: ASA01CC24-M Conduction Emission of EN55022 Class A
Vin = 24Vdc Load: $I_o = \pm 0.2A$

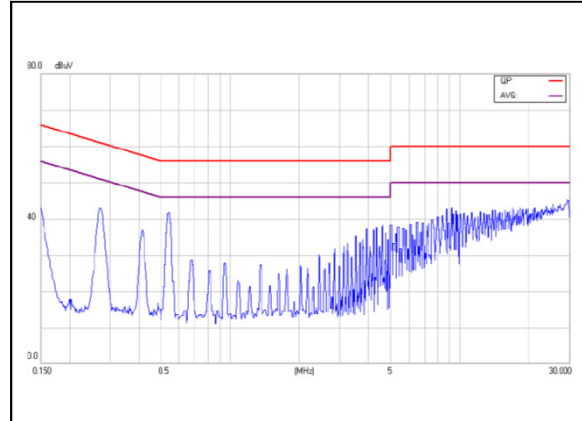

Figure 64: ASA01CC24-M Conduction Emission of EN55022 Class B
Vin = 24Vdc Load: $I_o = \pm 0.2A$

Note - All test conditions are at 25 °C

ASA01A48-M Performance Curves

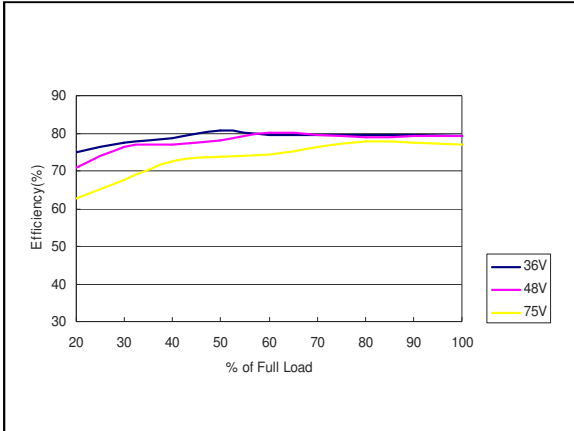

Figure 65: ASA01A48-M Efficiency Versus Output Current Curve
 Vin = 36 to 75Vdc Load: Io = 0 to 1A

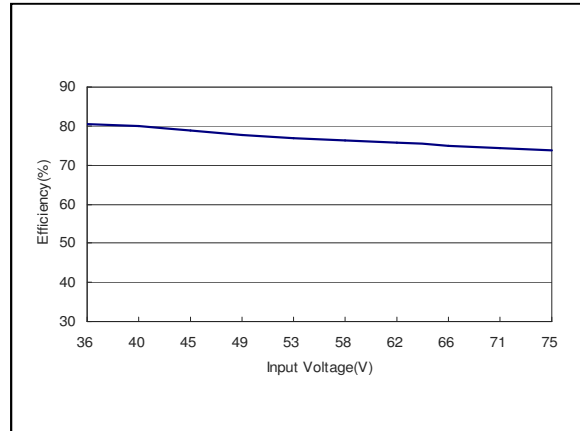

Figure 66: ASA01A48-M Efficiency Versus Input Voltage Curve
 Vin = 36 to 75Vdc Load: Io = 1A

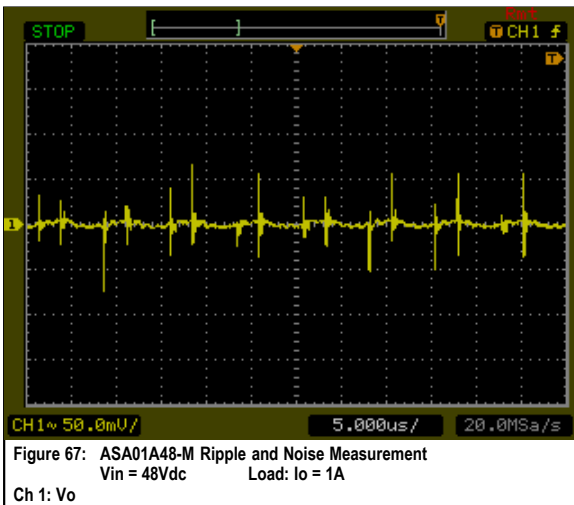

Figure 67: ASA01A48-M Ripple and Noise Measurement
 Vin = 48Vdc Load: Io = 1A
 Ch 1: Vo

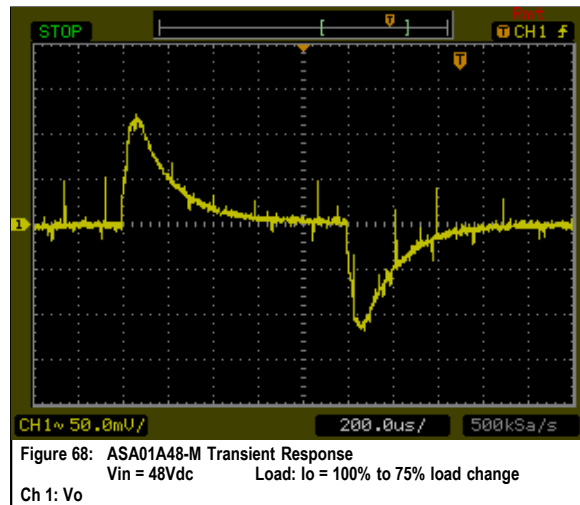

Figure 68: ASA01A48-M Transient Response
 Vin = 48Vdc Load: Io = 100% to 75% load change
 Ch 1: Vo

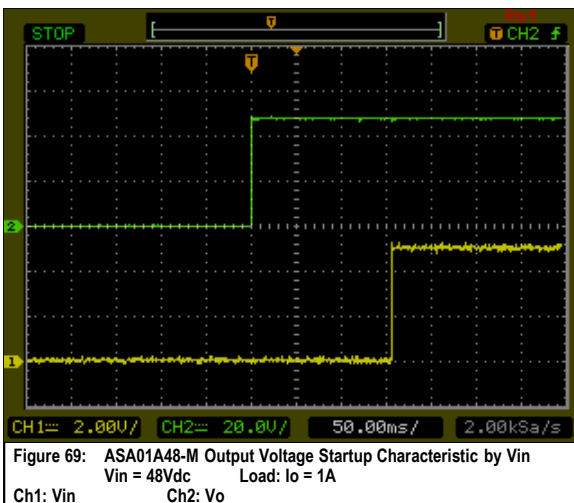

Figure 69: ASA01A48-M Output Voltage Startup Characteristic by Vin
 Vin = 48Vdc Load: Io = 1A
 Ch1: Vin Ch2: Vo

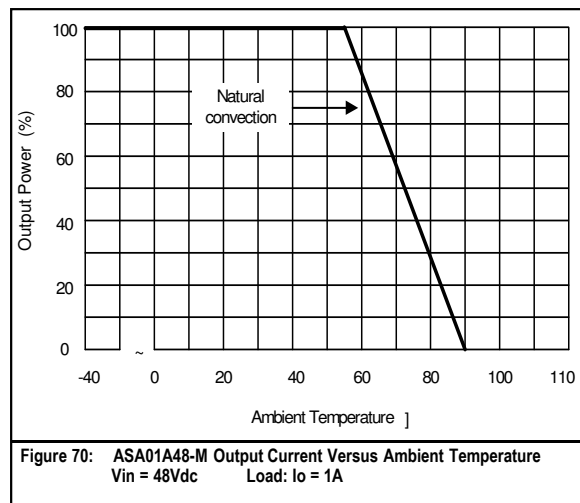

Figure 70: ASA01A48-M Output Current Versus Ambient Temperature
 Vin = 48Vdc Load: Io = 1A

ASA01A48-M Performance Curves

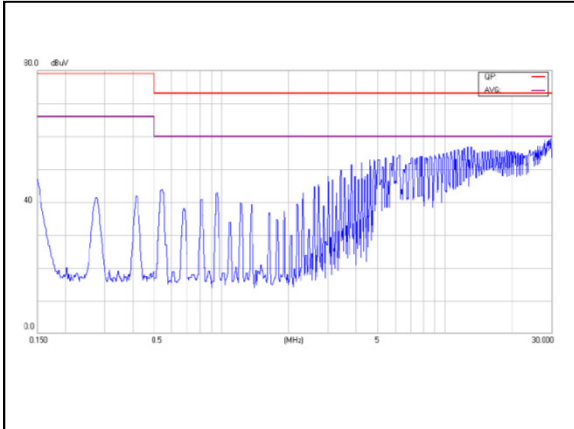

Figure 71: ASA01A48-M Conduction Emission of EN55022 Class A
Vin = 48Vdc Load: Io = 1A

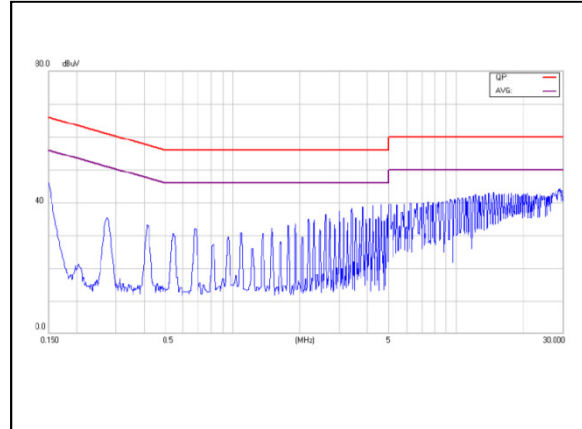

Figure 72: ASA01A48-M Conduction Emission of EN55022 Class B
Vin = 48Vdc Load: Io = 1A

Note - All test conditions are at 25 °C

ASA01B48-M Performance Curves

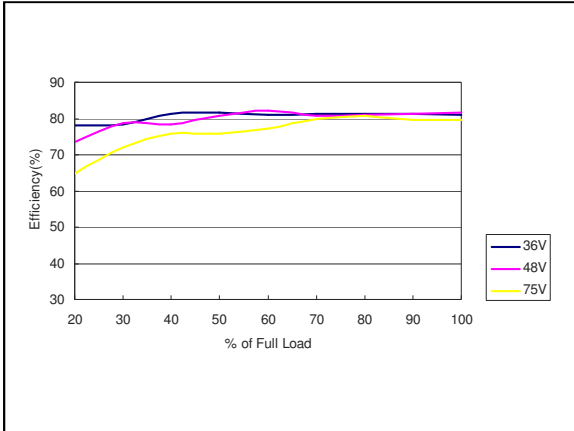

Figure 73: ASA01B48-M Efficiency Versus Output Current Curve
 Vin = 36 to 75Vdc Load: Io = 0 to 0.5A

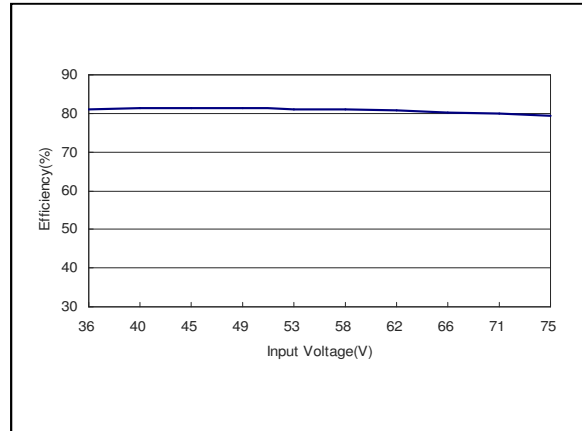

Figure 74: ASA01B48-M Efficiency Versus Input Voltage Curve
 Vin = 36 to 75Vdc Load: Io = 0.5A

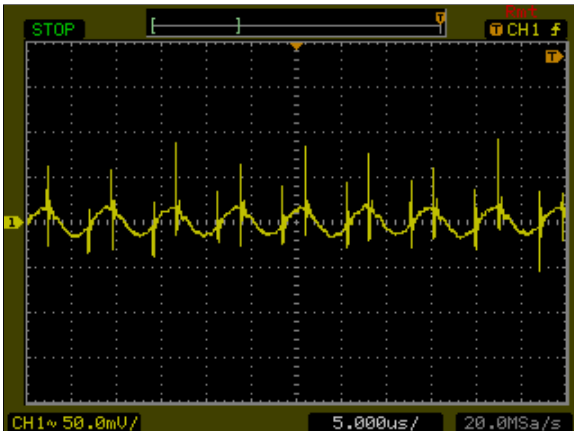

Figure 75: ASA01B48-M Ripple and Noise Measurement
 Vin = 48Vdc Load: Io = 0.5A
 Ch 1: Vo

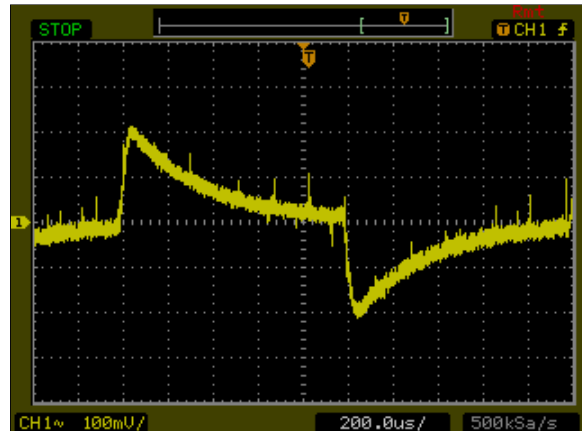

Figure 76: ASA01B48-M Transient Response
 Vin = 48Vdc Load: Io = 100% to 75% load change
 Ch 1: Vo

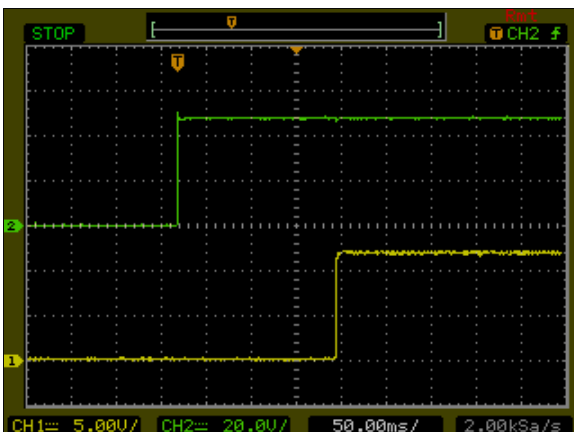

Figure 77: ASA01B48-M Output Voltage Startup Characteristic by Vin
 Vin = 48Vdc Load: Io = 0.5A
 Ch1: Vin Ch2: Vo

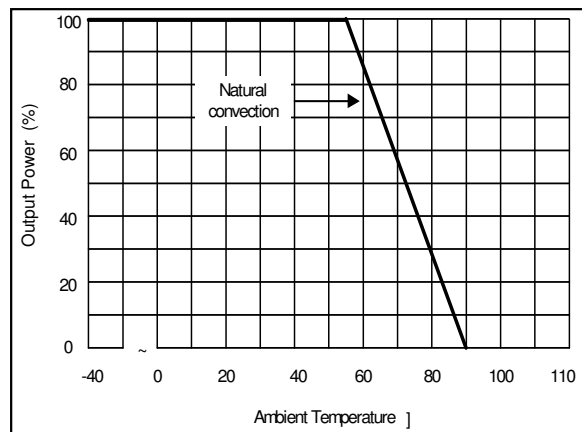

Figure 78: ASA01B48-M Output Current Versus Ambient Temperature
 Vin = 48Vdc Load: Io = 0.5A

ASA01B48-M Performance Curves

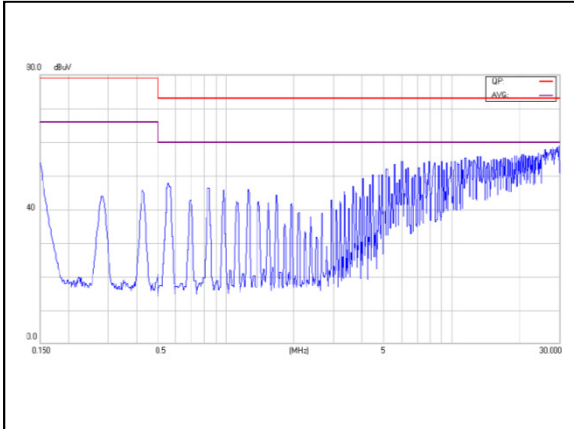

Figure 79: ASA01B48-M Conduction Emission of EN55022 Class A
Vin = 48Vdc Load: Io = 0.5A

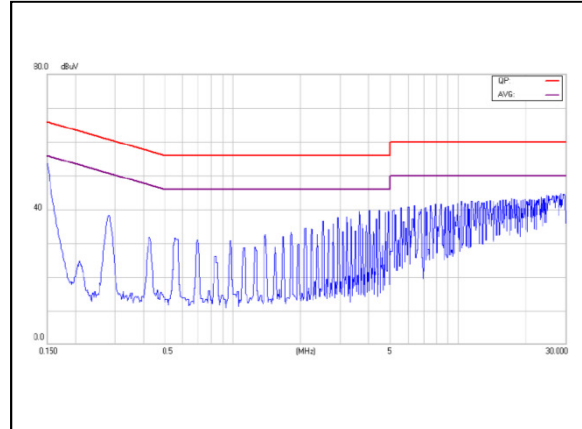

Figure 80: ASA01B48-M Conduction Emission of EN55022 Class B
Vin = 48Vdc Load: Io = 0.5A

Note - All test conditions are at 25 °C

ASA01BB48-M Performance Curves

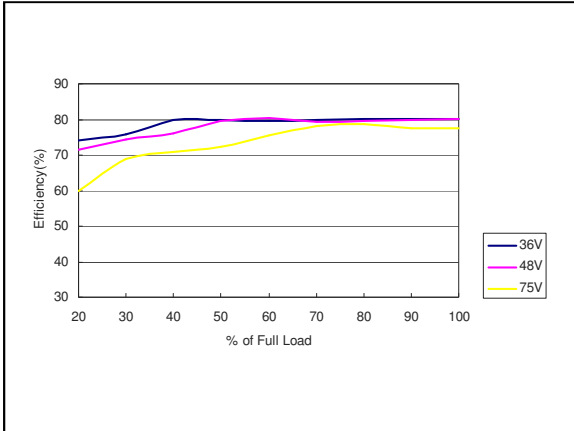

Figure 81: ASA01BB48-M Efficiency Versus Output Current Curve
 Vin = 36 to 75Vdc Load: Io = 0 to ± 0.25A

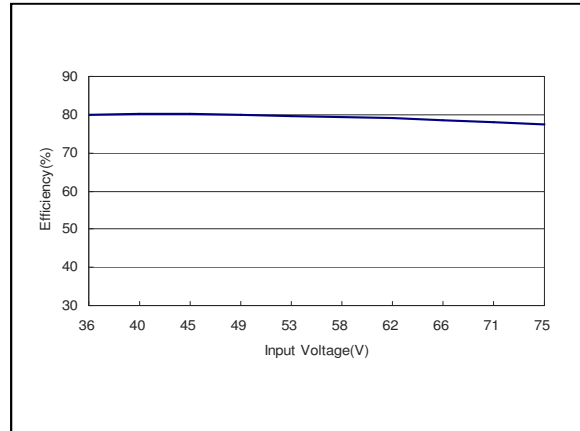

Figure 82: ASA01BB48-M Efficiency Versus Input Voltage Curve
 Vin = 36 to 75Vdc Load: Io = ± 0.25A

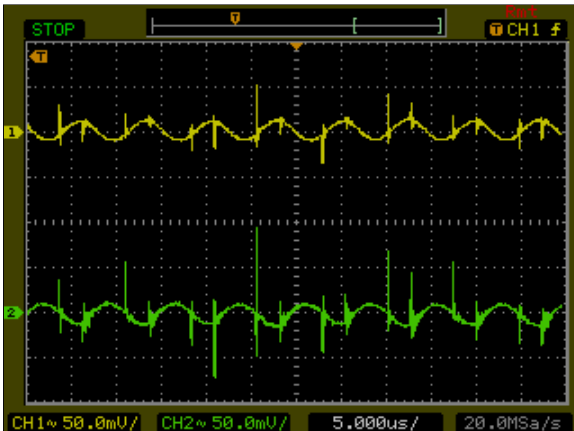

Figure 83: ASA01BB48-M Ripple and Noise Measurement
 Vin = 48Vdc Load: Io = ± 0.25A
 Ch 1: Vout1 Ch2: Vout2

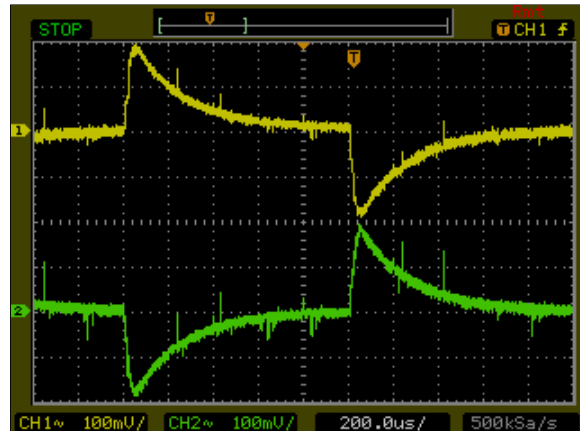

Figure 84: ASA01BB48-M Transient Response
 Vin = 48Vdc Load: Io = 100% to 75% load change
 Ch 1: Vout1 Ch2: Vout2

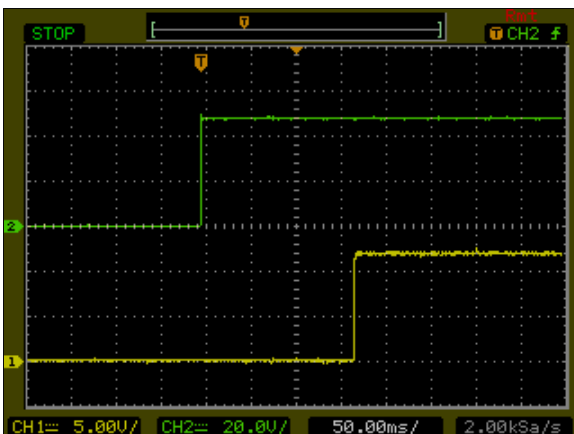

Figure 85: ASA01BB48-M Output Voltage Startup Characteristic by Vin
 Vin = 48Vdc Load: Io = ± 0.25A
 Ch1: Vin Ch2: Vo

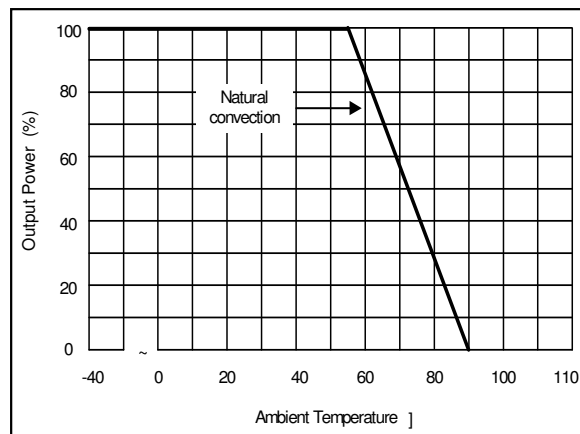

Figure 86: ASA01BB48-M Output Current Versus Ambient Temperature
 Vin = 48Vdc Load: Io = ± 0.25A

ASA01BB48-M Performance Curves

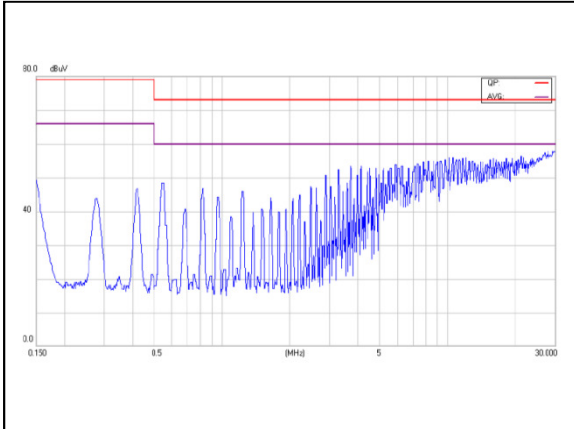

Figure 87: ASA01BB48-M Conduction Emission of EN55022 Class A
Vin = 48Vdc Load: Io = ± 0.25A

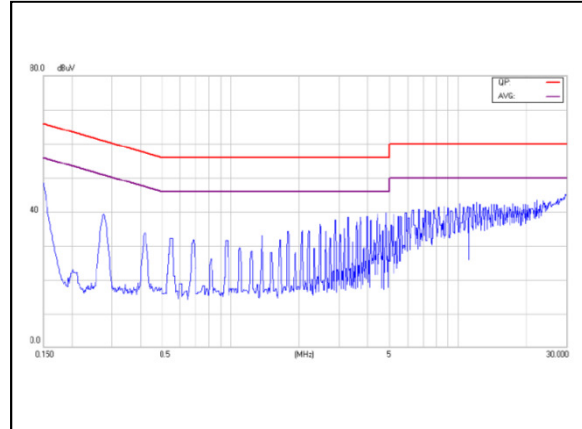

Figure 88: ASA01BB48-M Conduction Emission of EN55022 Class B
Vin = 48Vdc Load: Io = ± 0.25A

Note - All test conditions are at 25 °C

ASA01CC48-M Performance Curves

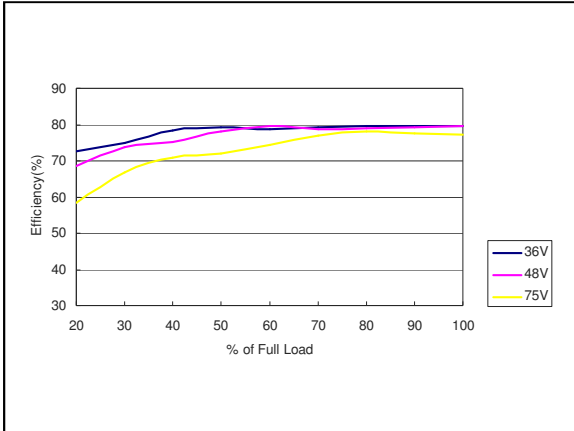

Figure 89: ASA01CC48-M Efficiency Versus Output Current Curve
 Vin = 36 to 75Vdc Load: Io = 0 to ± 0.2A

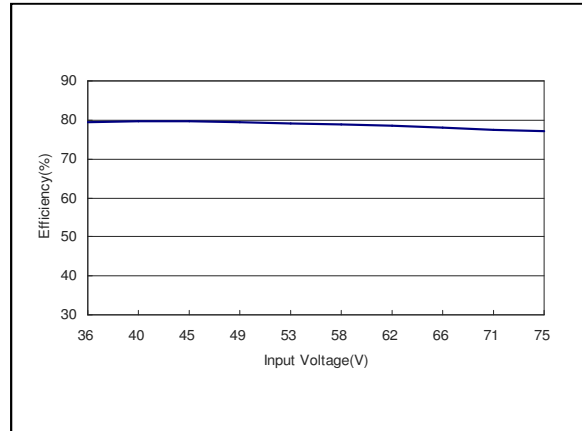

Figure 90: ASA01CC48-M Efficiency Versus Input Voltage Curve
 Vin = 36 to 75Vdc Load: Io = ± 0.2A

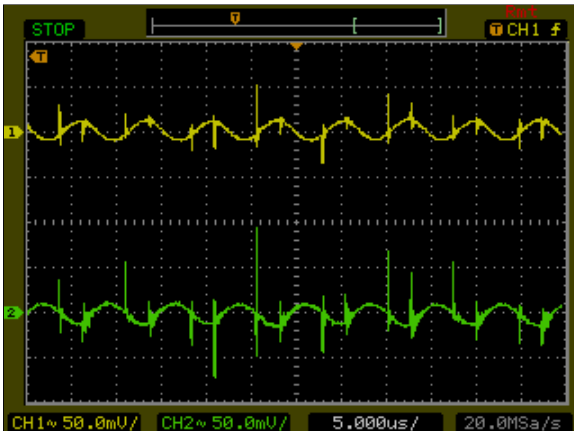

Figure 91: ASA01CC48-M Ripple and Noise Measurement
 Vin = 48Vdc Load: Io = ± 0.2A
 Ch 1: Vout1 Ch2: Vout2

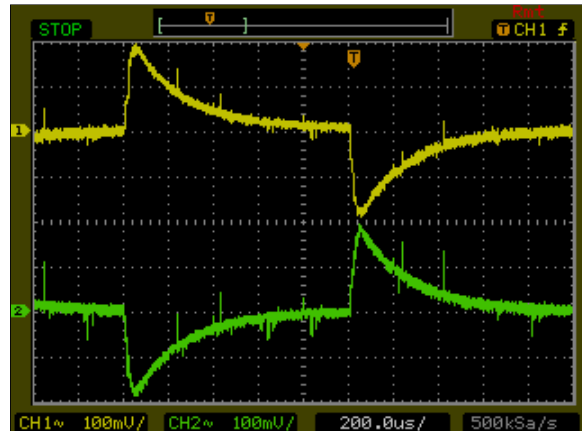

Figure 92: ASA01CC48-M Transient Response
 Vin = 48Vdc Load: Io = 100% to 75% load change
 Ch 1: Vout1 Ch2: Vout2

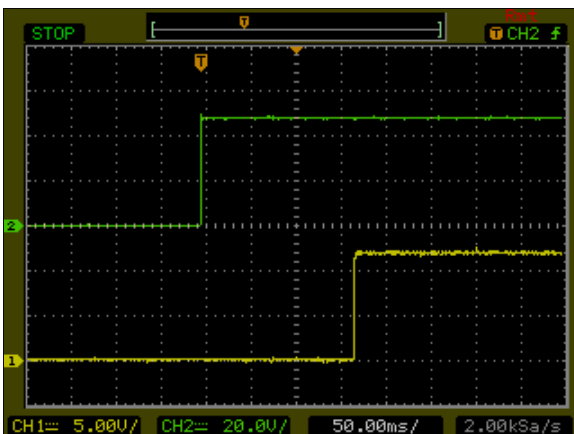

Figure 93: ASA01CC48-M Output Voltage Startup Characteristic by Vin
 Vin = 48Vdc Load: Io = ± 0.2A
 Ch1: Vin Ch2: Vo

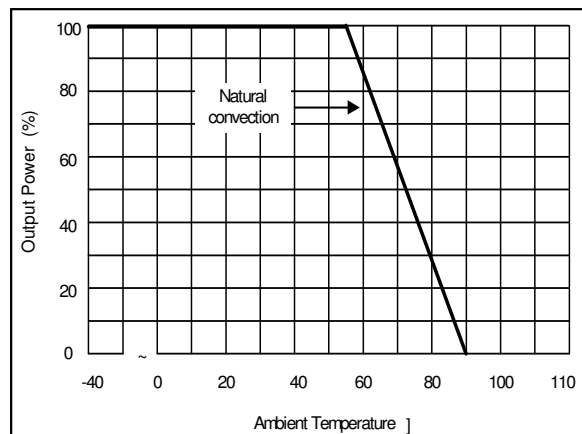

Figure 94: ASA01CC48-M Output Current Versus Ambient Temperature
 Vin = 48Vdc Load: Io = ± 0.2A

ASA01CC48-M Performance Curves

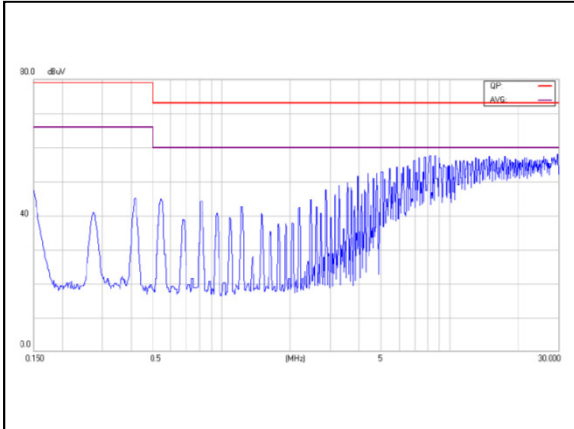

Figure 95: ASA01CC48-M Conduction Emission of EN55022 Class A
Vin = 48Vdc Load: $I_o = \pm 0.2A$

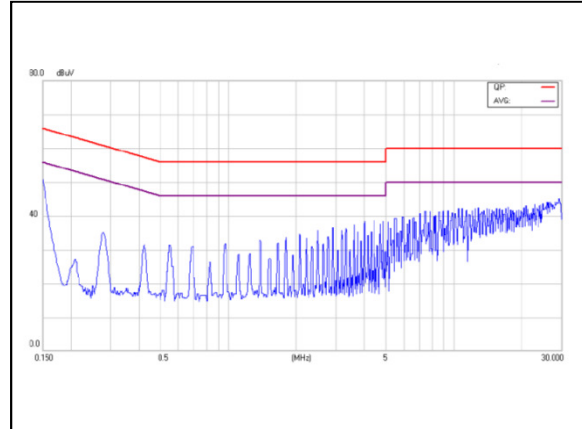
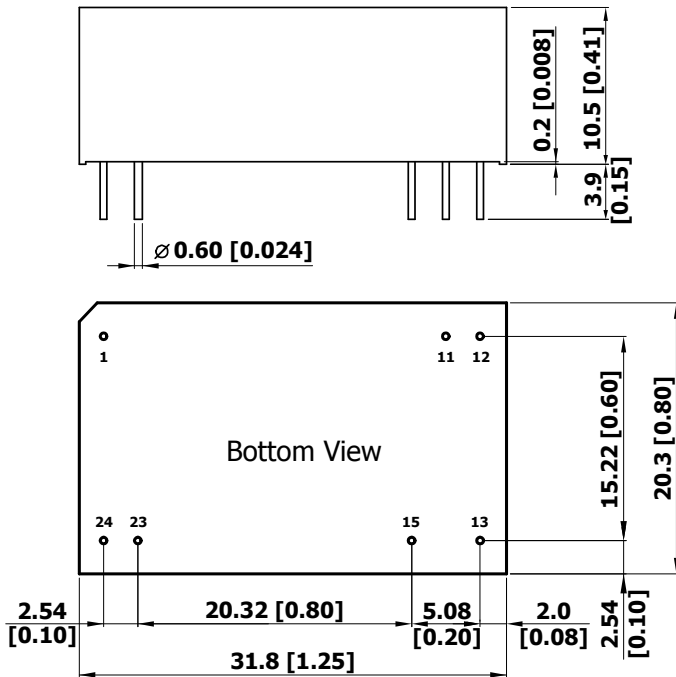

Figure 96: ASA01CC48-M Conduction Emission of EN55022 Class B
Vin = 48Vdc Load: $I_o = \pm 0.2A$

Note - All test conditions are at 25 °C

Mechanical Specifications

Mechanical Outlines



Note:

- All dimensions in mm (inches)
 Tolerance: X.X±0.25 (X.XX±0.01)
 X.XX±0.13 (X.XXX±0.005)
- Pin pitch tolerance:±0.25 (±0.01)
- Pin tolerance:±0.05 (±0.002)

Pin Connections

Single output

- Pin 1 – +Vin
- Pin 11 – No Pin
- Pin 12 – -Vout
- Pin 13 – +Vout
- Pin 15 – No Pin
- Pin 23 – -Vin
- Pin 24 – -Vin

Dual Output

- Pin 1 – +Vin
- Pin 11 – Common
- Pin 12 – No Pin
- Pin 13 – -Vout
- Pin 15 – +Vout
- Pin 23 – -Vin
- Pin 24 – -Vin

Physical Characteristics

Device code suffix	L
Case Size	31.8x20.3x12mm (1.25x0.8x0.47 inches)
Case Material	Non-Conductive Black Plastic (flammability to UL 94V-0 rated)
Weight	18g

Recommended Pad Layout for Single & Dual Output Converter

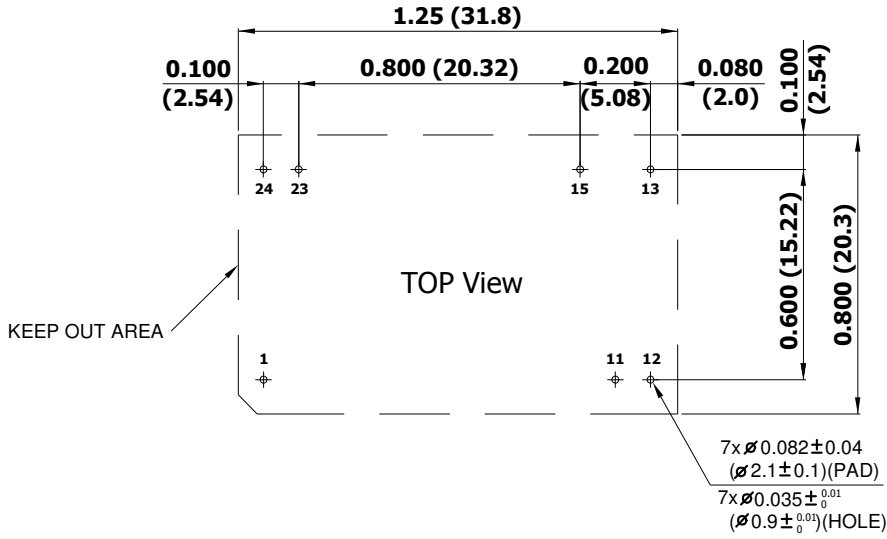

1. All dimensions in Inches (mm)
 Tolerance: x.xx±0.02" (x.x ±0.5mm)
 x.xxx±0.01" (x.xx ±0.25mm)
2. Pin pitch tolerance: ±0.01" (±0.25mm)

Power Derating Curves

ASA6W Series can operate up to a maximum ambient temperature of 75°C with derating.

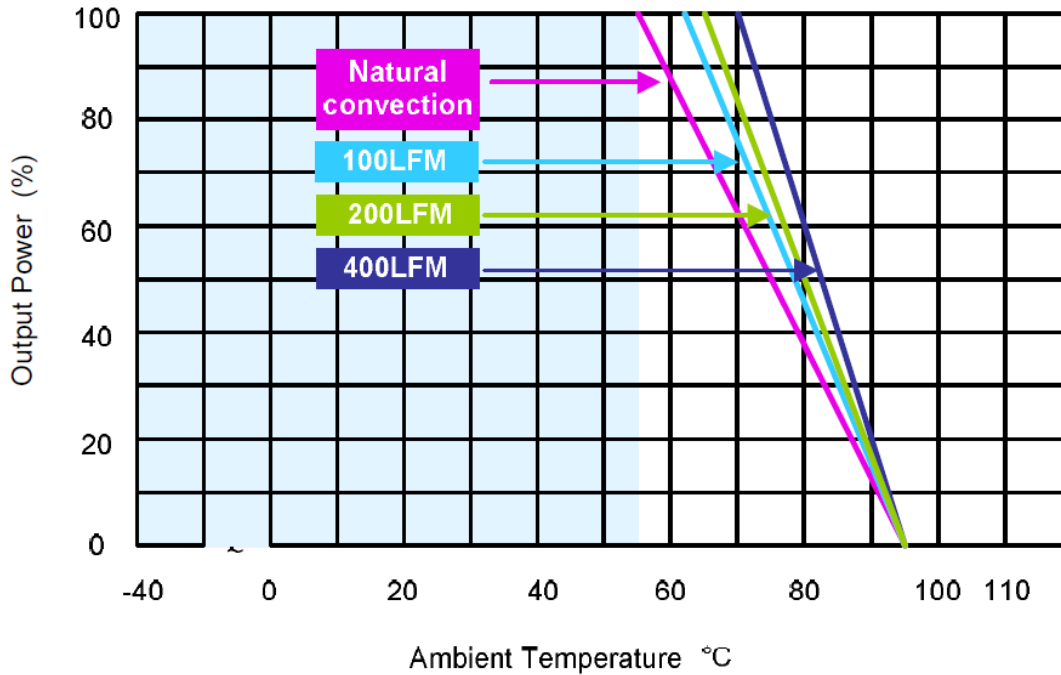

Notes:

1. Specifications typical at $T_a = +25^\circ\text{C}$, resistive load, nominal input voltage and rated output current unless otherwise noted.
2. Transient recovery time is measured to within 1% error band for a step change in output load of 75% to 100%.
3. Ripple & Noise measurement bandwidth is 0-20 MHz.
4. These power converters require a minimum output loading to maintain specified regulation, operation under no-load conditions will not damage these modules; however, they may not meet all specifications listed.
5. All DC/DC converters should be externally fused at the front end for protection.
6. Other input and output voltage may be available, please contact factory.
7. Specifications subject to change without notice.

EMC Considerations

EMI-Filter to meet EN 55022, class B, FCC part 15, class B

Conducted and radiated emissions EN55022 Class B

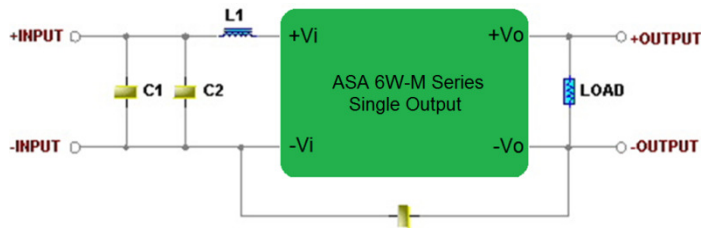

Single Output

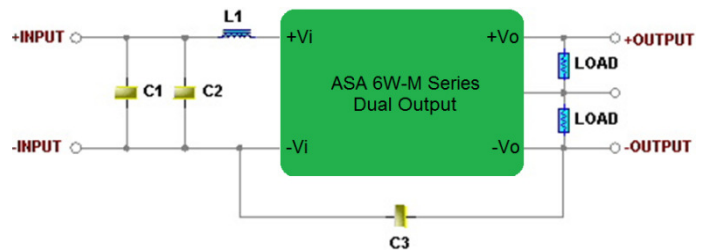

Dual Output

Recommended PCB Layout with Input Filter

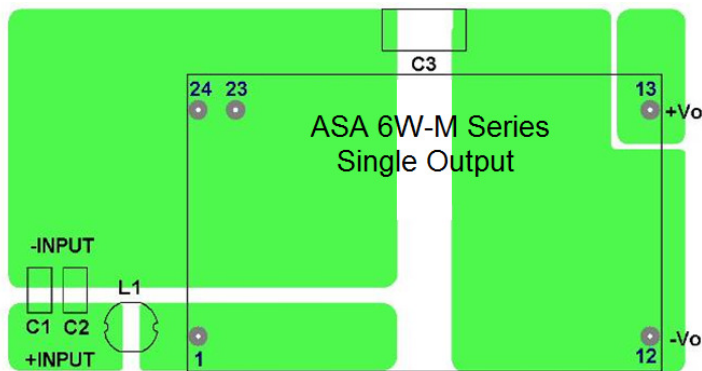

Single Output

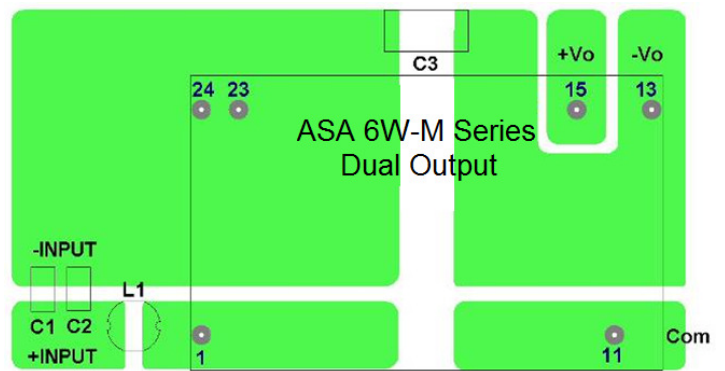

Dual Output

Table 4. Conducted EMI emission specifications

Model	Component	Value
ASAXXX12-M	C1	4.7 μ F/25V 1206 MLCC
	C3	100pF/6KV 2211 MLCC
	L1	1 μ H SCD03021T/2.08A
ASAXXX24-M	C1,C2	2.2 μ F/50V 1206 MLCC
	C3	100pF/6KV 2211 MLCC
	L1	1 μ H SCD03021T/2.08A
ASAXXX48-M	C1,C2	1 μ F/100V 1206 MLCC
	C3	100pF/6KV 2211 MLCC
	L1	1 μ H SCD03021T/2.08A

Safety Certifications

The ASA 6W-M series power supply is intended for inclusion in other equipment and the installer must ensure that it is in compliance with all the requirements of the end application. This product is only for inclusion by professional installers within other equipment and must not be operated as a stand alone product.

Table 5. Safety Certifications for ASA 6W-M series power supply system

Document	Description
cUL/UL 60950-1 (CSA certificate)	US and Canada Requirements
IEC/EN 60950-1 (CB-scheme)	European Requirements

MTBF and Reliability

The MTBF of ASA6W series of DC/DC converters has been calculated using MIL-HDBK 217F NOTICE2, Operating Temperature 25 °C, Ground Benign.

Model	MTBF	Unit
ASA01A12-M	1,056,971	Hours
ASA001B12-M	1,065,303	
ASA01BB12-M	1,070,778	
ASA01CC12-M	1,077,122	
ASA01A24-M	1,045,697	
ASA01B24-M	1,040,583	
ASA01BB24-M	1,053,741	
ASA01CC24-M	1,058,985	
ASA01A48-M	1,033,699	
ASA01B48-M	1,056,189	
ASA01BB48-M	1,040,583	
ASA01CC48-M	1,051,746	

Application Notes

Input Reflected-Ripple Current Test Setup

Input reflected-ripple current is measured with an inductor L_{in} ($4.7\mu\text{H}$) and C_{in} ($220\mu\text{F}$, $\text{ESR} < 1.0\Omega$ at 100 KHz) to simulate source impedance. Capacitor C_{in} , offsets possible battery impedance. Current ripple is measured at the input terminals of the module, measurement bandwidth is $0\text{-}500\text{ KHz}$.

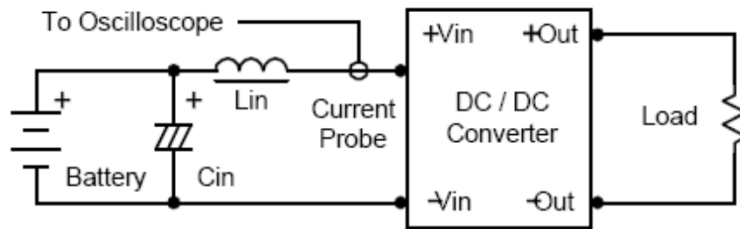

Component	Value	Reference
Lin	$4.7\mu\text{H}$	-
Cin	$220\mu\text{F}$ ($\text{ESR} < 1.0\Omega$ at 100 KHz)	Aluminum Electrolytic Capacitor

Peak-to-Peak Output Noise Measurement Test

Use a 0.47uF ceramic capacitor. Scope measurement should be made by using a BNC socket, measurement bandwidth is 0-20MHz. Position the load between 50 mm and 75 mm from the DC/DC Converter.

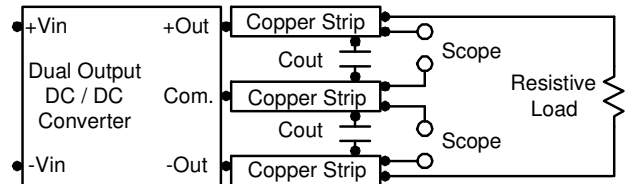
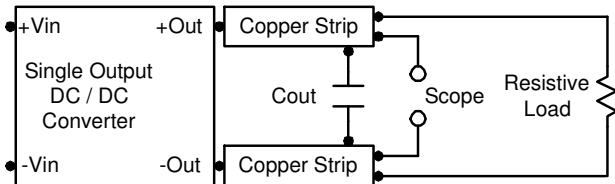

Output voltage and efficiency measurement test set up

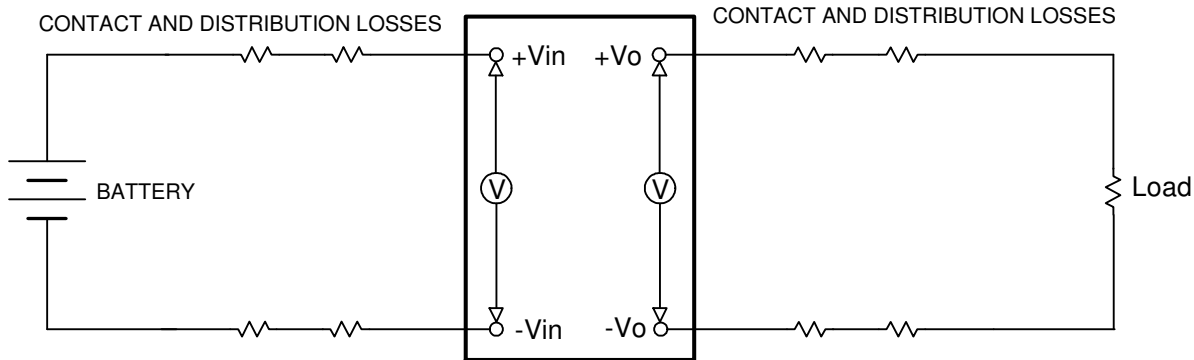

$$Efficiency = \left(\frac{V_{out} \times I_{out}}{V_{in} \times I_{in}} \right) \times 100\% = [\%]$$

Short Circuitry Protection

Continuous, hiccup and auto-recovery mode.

During short circuit, converter still shut down, The average current during this condition will be very low and the device will be safe in this condition.

Input Source Impedance

The power module should be connected to a low ac-impedance input source. Highly inductive source impedances can affect the stability of the power module.

In applications where power is supplied over long lines and output loading is high, it may be necessary to use a capacitor at the input to ensure startup.

Capacitor mounted close to the power module helps ensure stability of the unit, it is recommended to use a good quality low Equivalent Series Resistance ($ESR < 1.0\Omega$ at 100 KHz) capacitor of a $10\mu F$ for the 12V input devices and a $4.7\mu F$ for the 24V input devices and a $2.2\mu F$ for the 48V devices.

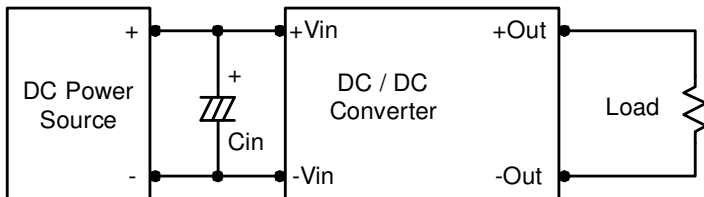

Thermal Considerations

Many conditions affect the thermal performance of the power module, such as orientation, airflow over the module and board spacing. To avoid exceeding the maximum temperature rating of the components inside the power module, the case temperature must be kept below 95°C. The derating curves are determined from measurements obtained in a test setup.

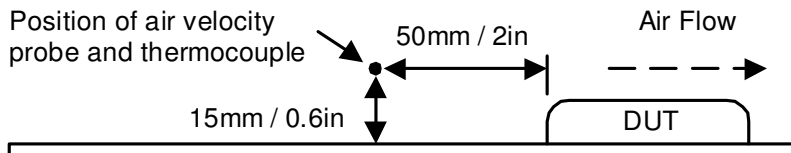

Maximum Capacitive Load

The ASA6W series has limitation of maximum connected capacitance at the output. The power module may be operated in current limiting mode during start-up, affecting the ramp-up and the startup time. Connect capacitors at the point of load for best performance. The maximum capacitance can be found in the data sheet.

Packaging Information

TUBE

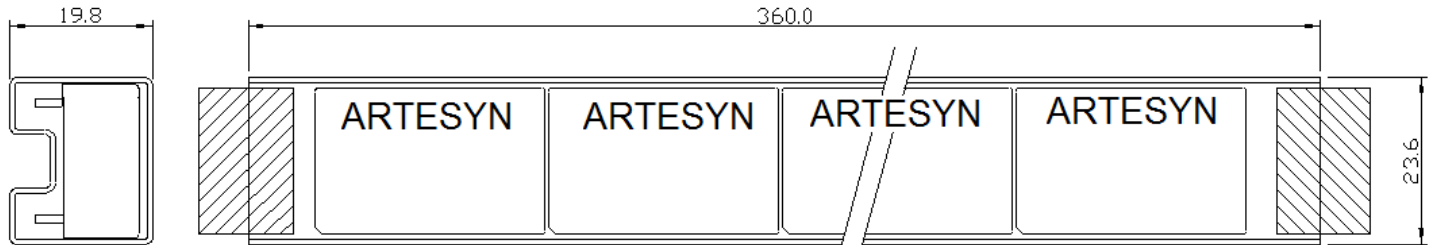

unit : mm

10 PCS per TUBE

Soldering and Reflow Considerations

Lead free wave solder profile for ASA6W Series

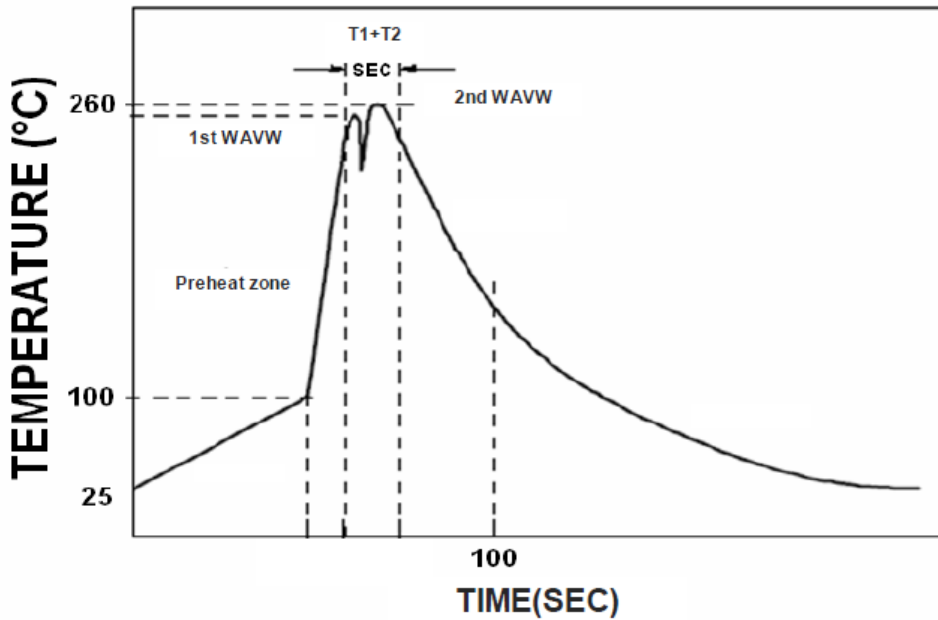

Weight

The ASA6W series weight is 18g maximum.

Record of Revision and Changes

Issue	Date	Description	Originators
1.0	07.11.2016	First Issue	S. Dong

WORLDWIDE OFFICES

Americas

2900 South Diablo Way
Suite B100
Tempe, AZ 85282
USA
+1 888 412 7832

Europe (UK)

Ground Floor Offices
Barberry House, 4 Harbour Buildings
Waterfront West, Brierley Hill
West Midlands, DY5 1LN, UK
+44 (0) 1384 842 211

Asia (HK)

14/F, Lu Plaza
2 Wing Yip Street
Kwun Tong, Kowloon
Hong Kong
+852 2176 3333



For more information: www.artesyn.com
For support: productsupport.ep@artesyn.com

Artesyn Embedded Technologies, Artesyn Embedded Power, Artesyn, and all Artesyn related logos are trademarks and service marks of Artesyn Embedded Technologies, Inc. All other names and logos referred to are trade names, trademarks, or registered trademarks of their respective owners. Specifications are subject to change without notice. © 2019 Artesyn Embedded Technologies, Inc. All rights reserved. For full legal terms and conditions, please visit www.artesyn.com/legal.