



Is Now Part of



ON Semiconductor®

To learn more about ON Semiconductor, please visit our website at

www.onsemi.com

ON Semiconductor and the ON Semiconductor logo are trademarks of Semiconductor Components Industries, LLC dba ON Semiconductor or its subsidiaries in the United States and/or other countries. ON Semiconductor owns the rights to a number of patents, trademarks, copyrights, trade secrets, and other intellectual property. A listing of ON Semiconductor's product/patent coverage may be accessed at www.onsemi.com/site/pdf/Patent-Marking.pdf. ON Semiconductor reserves the right to make changes without further notice to any products herein. ON Semiconductor makes no warranty, representation or guarantee regarding the suitability of its products for any particular purpose, nor does ON Semiconductor assume any liability arising out of the application or use of any product or circuit, and specifically disclaims any and all liability, including without limitation special, consequential or incidental damages. Buyer is responsible for its products and applications using ON Semiconductor products, including compliance with all laws, regulations and safety requirements or standards, regardless of any support or applications information provided by ON Semiconductor. "Typical" parameters which may be provided in ON Semiconductor data sheets and/or specifications can and do vary in different applications and actual performance may vary over time. All operating parameters, including "Typicals" must be validated for each customer application by customer's technical experts. ON Semiconductor does not convey any license under its patent rights nor the rights of others. ON Semiconductor products are not designed, intended, or authorized for use as a critical component in life support systems or any FDA Class 3 medical devices or medical devices with a same or similar classification in a foreign jurisdiction or any devices intended for implantation in the human body. Should Buyer purchase or use ON Semiconductor products for any such unintended or unauthorized application, Buyer shall indemnify and hold ON Semiconductor and its officers, employees, subsidiaries, affiliates, and distributors harmless against all claims, costs, damages, and expenses, and reasonable attorney fees arising out of, directly or indirectly, any claim of personal injury or death associated with such unintended or unauthorized use, even if such claim alleges that ON Semiconductor was negligent regarding the design or manufacture of the part. ON Semiconductor is an Equal Opportunity/Affirmative Action Employer. This literature is subject to all applicable copyright laws and is not for resale in any manner.

FDZ2040L

Integrated Load Switch

Features

- Optimized for Low-Voltage Core ICs in Portable Systems
- Very Small Package Dimension: WL-CSP
0.8 X 0.8 X 0.5 mm³
- Current = 1.2 A, V_{IN} max. = 4 V
- Current = 2 A, V_{IN} max. = 4 V (Pulsed)
- R_{DS(ON)} = 80 mΩ at V_{ON} = 0 V, V_{IN} = 4 V
- R_{DS(ON)} = 85 mΩ at V_{ON} = 0 V, V_{IN} = 3.6 V
- R_{DS(ON)} = 90 mΩ at V_{ON} = 0 V, V_{IN} = 3 V
- RoHS Compliant



General Description

This device is particularly suited for compact power management in portable applications where 1.6 V to 4 V input and 1.2 A output current capability are needed. This load switch integrates a level-shifting function that drives a P-channel power MOSFET in the very small 0.8 X 0.8 X 0.5 mm³ WL-CSP package.

Applications

- Load Switch
- Power Management in Portable Applications

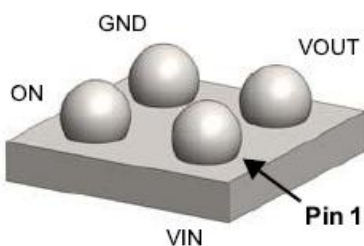

BOTTOM

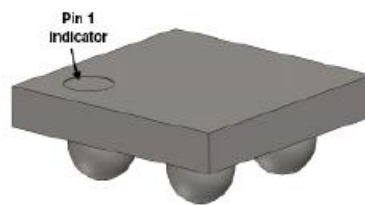

TOP

Ordering Information

Part Number	Device Marking	Ball Pitch	Operating Temperature Range	Switch	Package	Packing Method
FDZ2040L	ZL	0.4 mm	-25 to 75°C	80 mΩ, P-Channel MOSFET	0.8x0.8x0.5 mm ³ WL-CSP	Tape and Reel

Application Diagram and Block Diagram

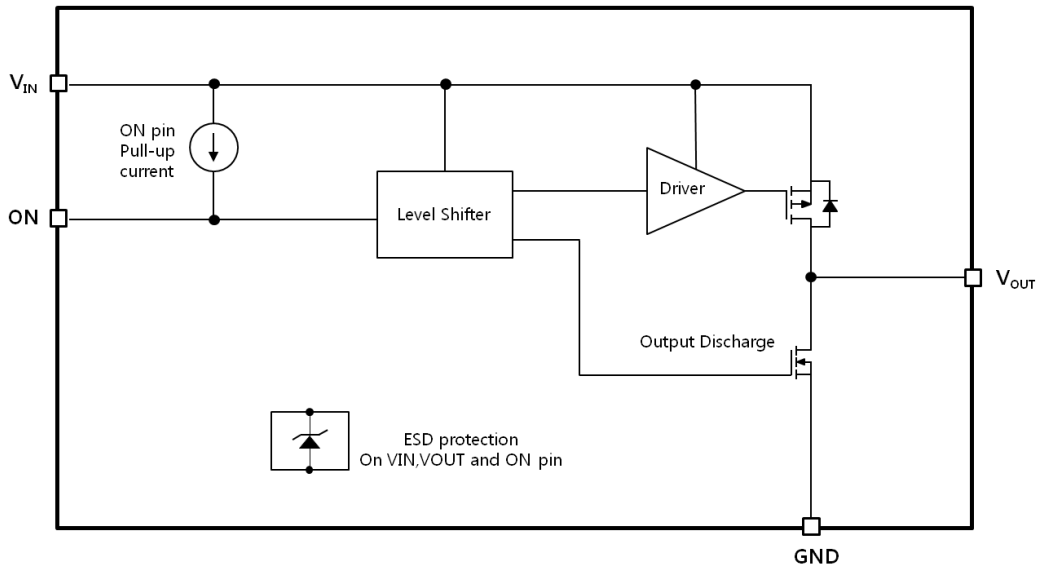

Figure 1. Block Diagram and Typical Application Pin Configuration

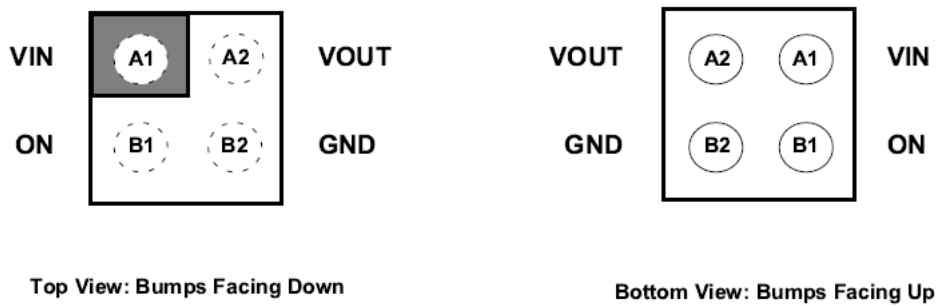

Figure 2. Pin Assignment

Pin Definitions

Pin #	Name	Description
A1	V _{IN}	Supply Input: Input to the load switch
A2	V _{OUT}	Switch Output: Output of the load switch
B1	ON	ON/OFF Control Input, Active LOW
B2	GND	Ground

Absolute Maximum Ratings

Parameter		Min.	Max.	Unit
V_{IN} , V_{OUT} , ON to GND		-0.3	4.2	V
I_{OUT} – Load Current (Continuous) ^(1a)			1.2	A
I_{OUT} – Load Current (Pulsed) ⁽²⁾			2	A
Power Dissipation @ $T_A = 25^\circ\text{C}$ ^(1a)			0.9	W
Operating Temperature Range		-40	105	$^\circ\text{C}$
Storage Temperature		-65	150	$^\circ\text{C}$
Electrostatic Discharge Capability	Human Body Model, JESD22-A114	8		kV
	Charged Device Model, JESD22-C101	2		

Thermal Characteristics

Parameter	Min.	Max.	Unit
Thermal Resistance, Junction to Ambient ^(1a)		117	$^\circ\text{C}/\text{W}$

Recommended Operating Conditions

Parameter	Min.	Max.	Unit
V_{IN}	1.6	4.0	V
Ambient Operating Temperature, T_A	-25	75	$^\circ\text{C}$

Notes:

- $R_{\theta JA}$ is the sum of the junction-to-case and case-to-ambient thermal resistance where the case thermal reference is defined as the solder mounting surface of the drain pins. $R_{\theta JC}$ is guaranteed by design while $R_{\theta JA}$ is determined by the user's board design.

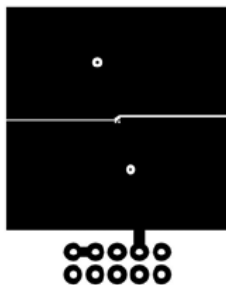

a. 117 $^\circ\text{C}/\text{W}$ when mounted on a 1 in² pad of 2 oz copper.



b. 277 $^\circ\text{C}/\text{W}$ when mounted on a minimum pad of 2 oz copper.

- Pulse Test: Pulse Width < 300 μs , Duty Cycle < 2.0%.

Electrical Characteristics

$T_J = 25\text{ }^\circ\text{C}$ unless otherwise noted.

Symbol	Parameter	Test Conditions	Min.	Typ.	Max.	Unit
V_{IN}	Operation Voltage		1.6		4.0	V
V_{IL}	ON Input Logic LOW Voltage	$V_{IN} = 1.6\text{ V}$, Ramp-Down V_{ON} from 1 V to 0 V, V_{OUT} LOW to HIGH, $T_J = -25$ to $75\text{ }^\circ\text{C}$			0.35	V
		$V_{IN} = 4\text{ V}$, Ramp-Down V_{ON} from 1 V to 0 V, V_{OUT} LOW to HIGH, $T_J = -25$ to $75\text{ }^\circ\text{C}$			0.35	V
V_{IH}	ON Input Logic HIGH Voltage	$V_{IN} = 1.6\text{ V}$, Ramp-Up V_{ON} from 0 V to 1 V, V_{OUT} HIGH to LOW, $T_J = -25$ to $75\text{ }^\circ\text{C}$	1.35			V
		$V_{IN} = 4\text{ V}$, Ramp-Up V_{ON} from 0 V to 1 V, V_{OUT} HIGH to LOW, $T_J = -25$ to $75\text{ }^\circ\text{C}$	1.35			V
I_Q	Quiescent Current	$V_{IN} = 3\text{ V}$, $V_{ON} = 0.35\text{ V}$, $I_{OUT} = 0\text{ A}$, $T_J = -25$ to $75\text{ }^\circ\text{C}$		1.55	2.50	μA
I_{Q_off}	Off Supply Current	$V_{IN} = 3\text{ V}$, $V_{ON} = 1.3\text{ V}$, $I_{OUT} = 0\text{ A}$, $T_J = -25$ to $75\text{ }^\circ\text{C}$		2.4	6.5	μA
I_{SD_off}	Off Switch Current	$V_{IN} = 3\text{ V}$, $V_{ON} = 1.3\text{ V}$, $V_{OUT} = 0\text{ V}$, $T_J = -25$ to $75\text{ }^\circ\text{C}$		0.1	3.5	μA
I_{Q_off} (V_{ON} float)	Off Supply Current with ON Pin Floating	$V_{IN} = 3\text{ V}$, $V_{ON} = \text{Floating}$, $I_{OUT} = 0\text{ A}$		1.6	2.3	μA
		$V_{IN} = 3\text{ V}$, $V_{ON} = \text{Floating}$, $I_{OUT} = 0\text{ A}$, $T_J = -25$ to $75\text{ }^\circ\text{C}$		1.6	4.0	μA
$R_{PULL-DOWN}$	Output Pull-Down Resistance	$V_{IN}=3\text{ V}$, $I_{OUT}=10\text{ mA}$		22		Ω
$R_{DS(ON)}$	On Resistance	$V_{IN} = 1.6\text{ V}$, $V_{ON} = 0\text{ V}$, $I_{OUT} = 300\text{ mA}$		68	120	m Ω
		$V_{IN} = 3\text{ V}$, $V_{ON} = 0\text{ V}$, $I_{OUT} = 300\text{ mA}$		50	90	
		$V_{IN} = 3.6\text{ V}$, $V_{ON} = 0\text{ V}$, $I_{OUT} = 300\text{ mA}$		48	85	
		$V_{IN} = 4\text{ V}$, $V_{ON} = 0\text{ V}$, $I_{OUT} = 300\text{ mA}$, $T_J = -25$ to $75\text{ }^\circ\text{C}$		47	80	
$C_{V-ON(INP)}$	ON Input Capacitance	$T_J = -25$ to $75\text{ }^\circ\text{C}$			5	pF
$I_{ON(PULL-UP)}$	ON Pull-Up Current	$V_{IN} = 3\text{ V}$, $V_{ON} = 0\text{ V}$, $T_J = -25$ to $75\text{ }^\circ\text{C}$	0.30	0.76	1.20	μA

Switching Characteristics

Symbol	Parameter	Test Conditions	Min.	Typ.	Max.	Unit
t_{on}	Turn-On Time (V_{ON} 50% to V_{OUT} 90%)	$V_{IN}=3\text{ V}$, $V_{ON} = 0\text{ V}$ as Logic LOW and 1.3 V as Logic HIGH, $C_{OUT} = 1\text{ nF}$, $R_L = 30\text{ }\Omega$, $T_J = -25$ to $75\text{ }^\circ\text{C}$		45	150	ns
t_{don}	Turn-On Delay (V_{ON} 50% to V_{OUT} 10%)			35	100	ns
t_{rise}	Turn-On Rise Time (V_{OUT} 10% to 90%)			10	50	ns
t_{off}	Turn-Off Time (V_{ON} 50% to V_{OUT} 10%)			60	150	ns
t_{doff}	Turn-Off Delay (V_{ON} 50% to V_{OUT} 90%)			25	100	ns
t_{fall}	Turn-Off Fall Time (V_{OUT} 90% to 10%)			35	65	ns
$t_{don} - t_{doff}$	Turn-On Turn-Off Delay Delta				50	ns

Typical Performance Characteristics

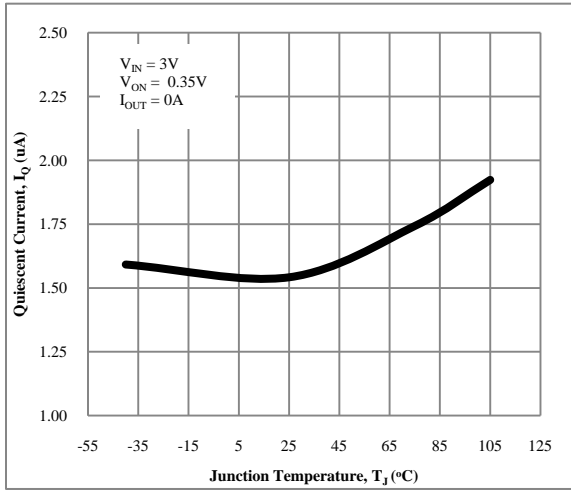

Figure 3. Quiescent Current vs. Temperature

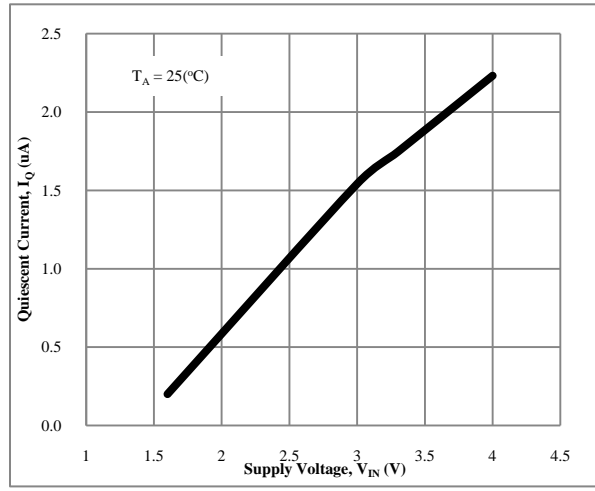

Figure 4. Quiescent Current vs. Supply Voltage

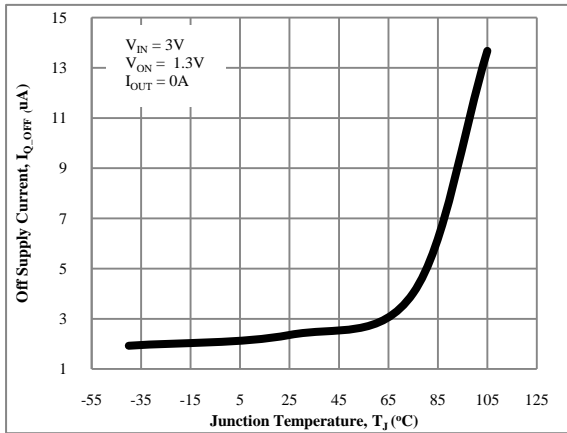

Figure 5. Off Supply Current vs. Temperature

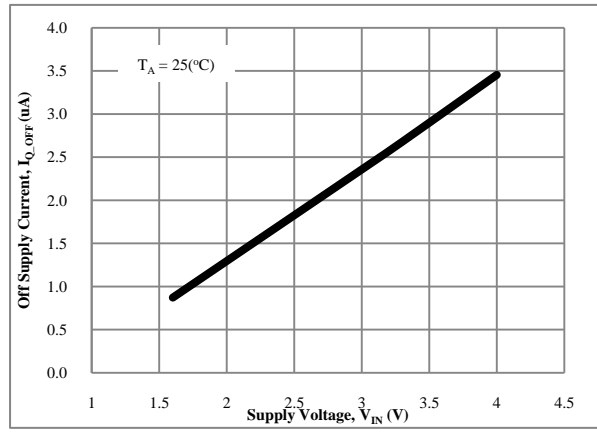

Figure 6. Off Supply Current vs. Supply Voltage

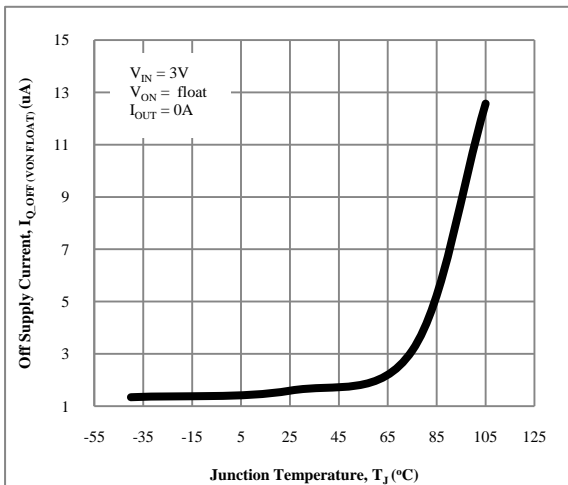

Figure 7. Off Supply Current (V_{ON} Float) vs. Temperature

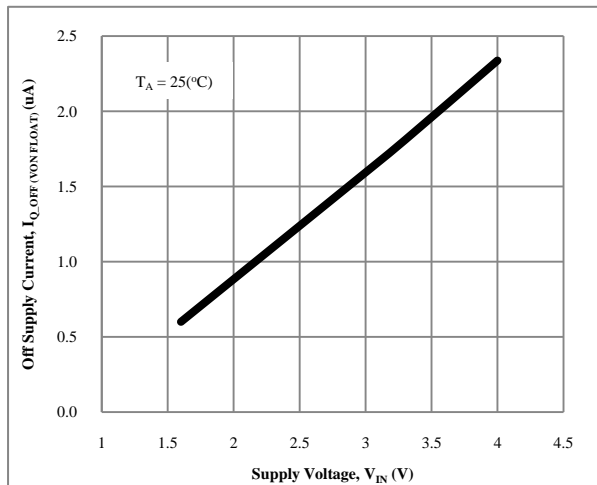

Figure 8. Off Supply Current (V_{ON} Float) vs. Supply Voltage

Typical Performance Characteristics (Continued)

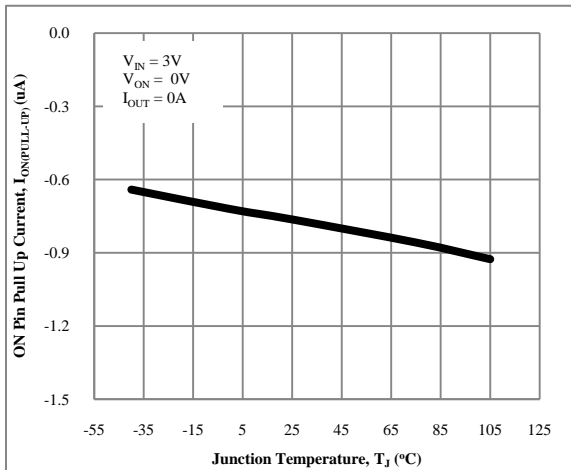

Figure 9. ON Pin Pull-Up Current vs. Temperature

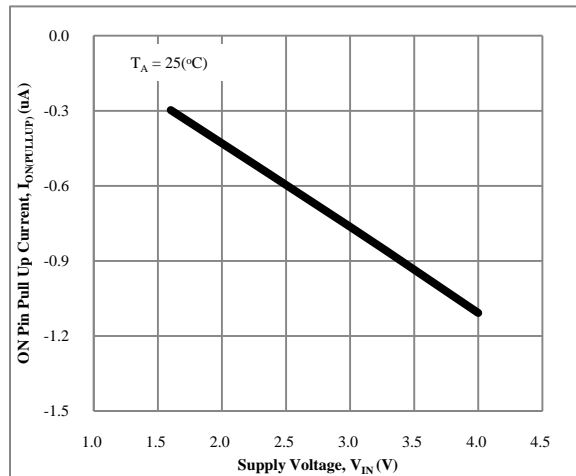

Figure 10. ON Pin Pull-Up Current vs. Supply Voltage

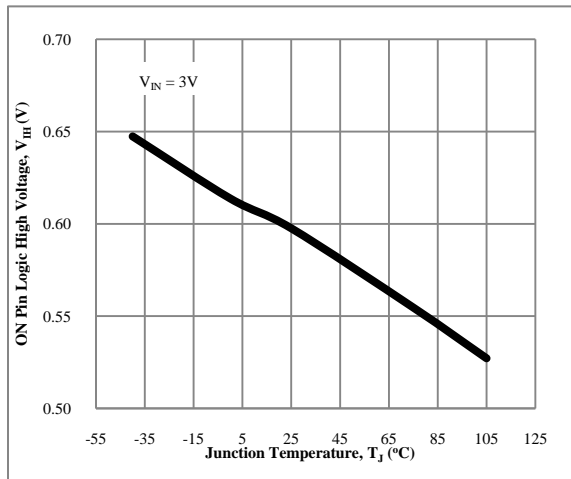

Figure 11. ON Pin Logic HIGH Voltage vs. Temperature

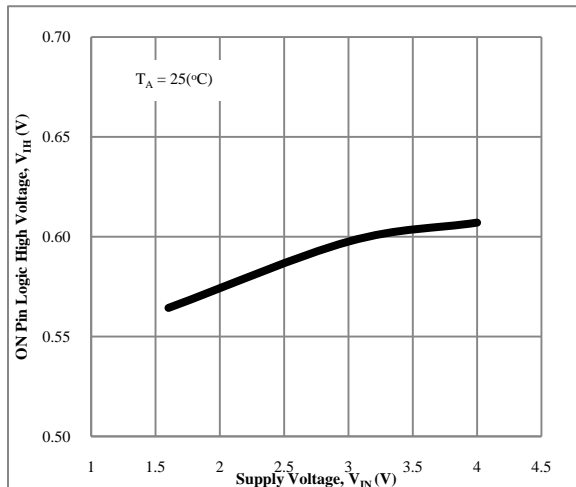

Figure 12. ON Pin Logic HIGH Voltage vs. Supply Voltage

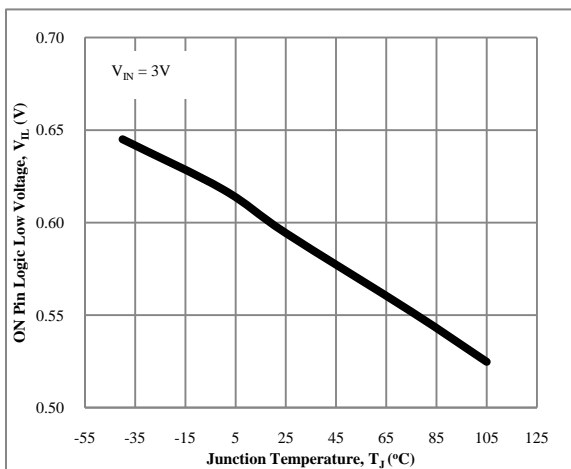

Figure 13. ON Pin Logic LOW Voltage vs. Temperature

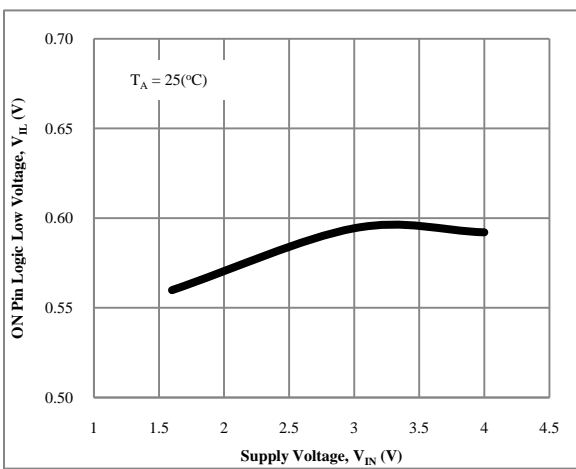

Figure 14. ON Pin Logic LOW Voltage vs. Supply Voltage

Typical Performance Characteristics (Continued)

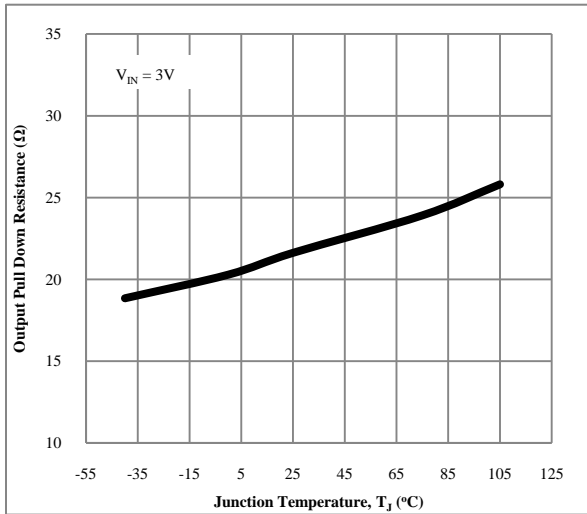

Figure 15. Output Pull-Down Resistance vs. Temperature

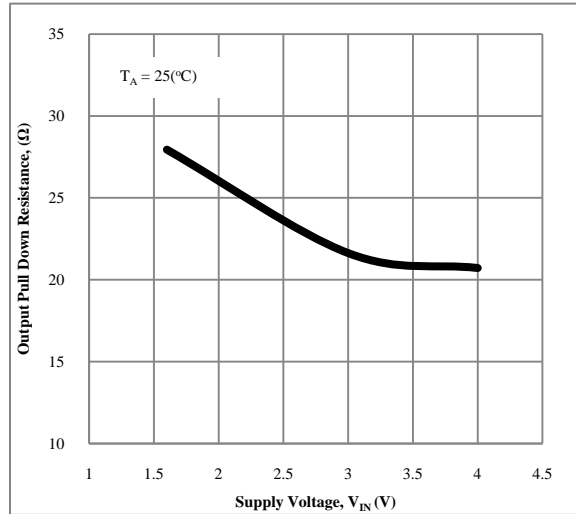

Figure 16. Output Pull-Down Resistance vs. Supply Voltage

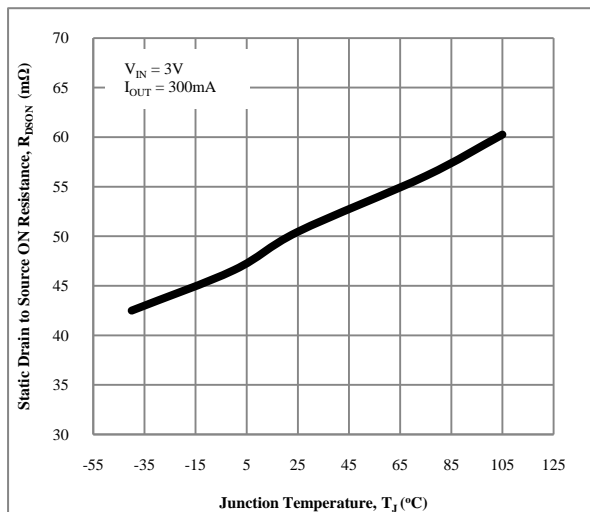

Figure 17. Static Drain-to-Source ON Resistance vs. Temperature

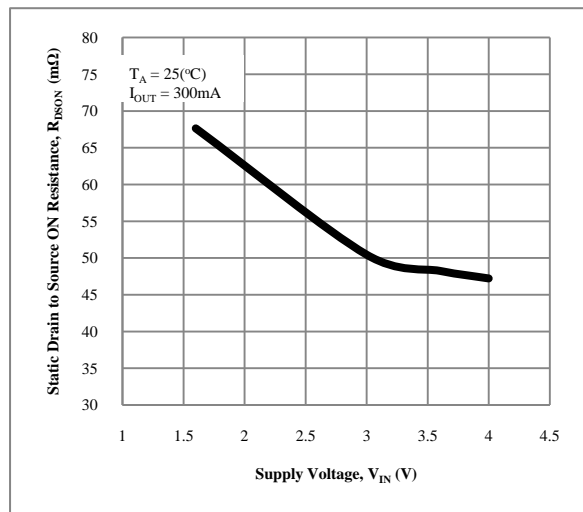
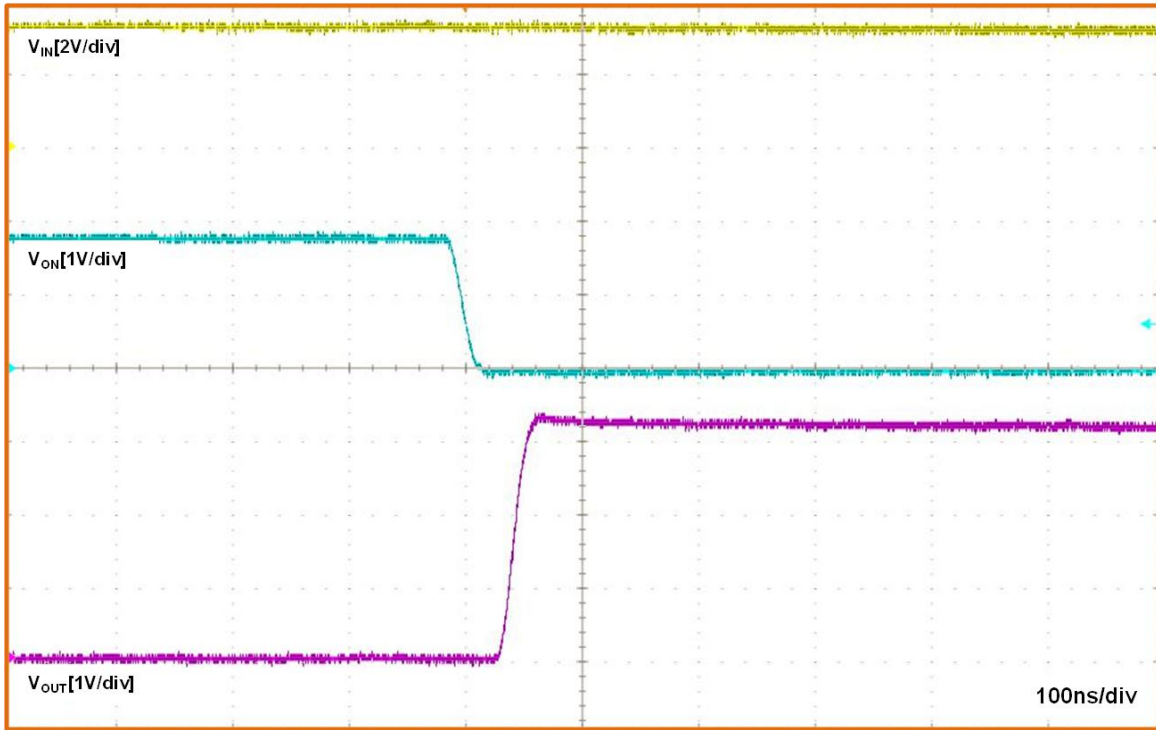

Figure 18. Static Drain-to-Source ON Resistance vs. Supply Voltage

Typical Performance Characteristics (Continued)



$V_{IN} = 3.3\text{ V}$, $V_{ON} = 0\text{ V}$, $C_{IN} = 1\ \mu\text{F}$, $C_{OUT} = 1\ \text{nF}$, $R_L = 30\ \Omega$

Figure 19. t_{ON} Response

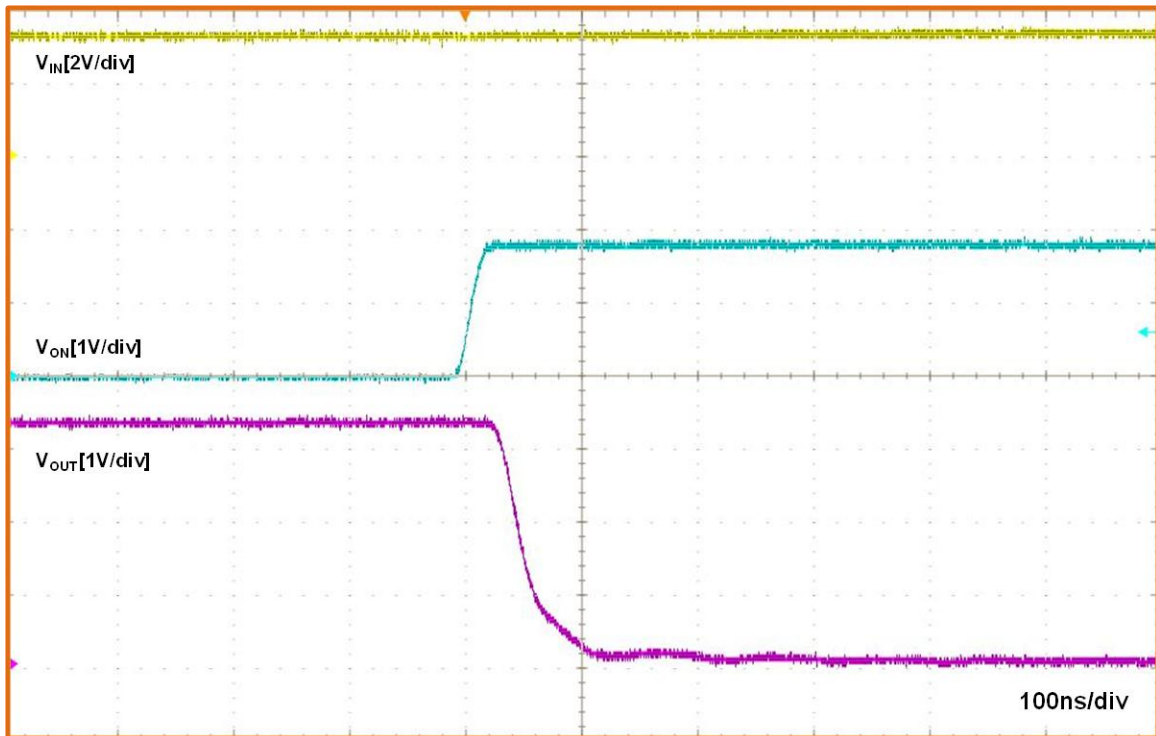

$V_{IN} = 3.3\text{ V}$, $V_{ON} = 0\text{ V}$, $C_{IN} = 1\ \mu\text{F}$, $C_{OUT} = 1\ \text{nF}$, $R_L = 30\ \Omega$

Figure 20. t_{OFF} Response

Operation Description

The FDZ2040L is a low- $R_{DS(ON)}$ P-channel load switch packaged in space-saving 0.8 x 0.8 WL-CSP.

The core of the device is an 80m Ω P-channel MOSFET and capable of functioning over a wide input operating range of 1.6 V-4 V.

Applications Information

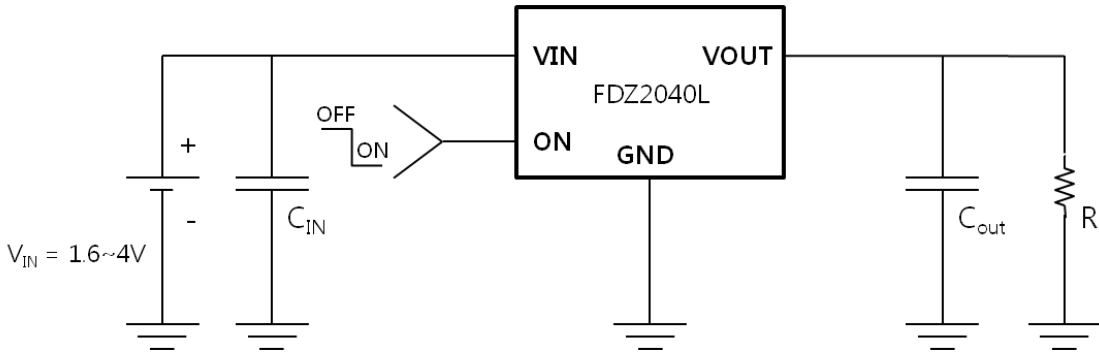

Figure 21. Typical Application

Input Capacitor

To reduce device inrush current effect, a 0.1 μ F ceramic capacitor, C_{IN} is recommended close to the V_{IN} pin. A higher value of C_{IN} can be used to further reduce the voltage drop experienced as the switch is turned on into a large capacitive load.

Output Capacitor

FDZ2040L switch works without an output capacitor. If parasitic board inductance forces V_{OUT} below GND when switching off, a 1 nF capacitor, C_{OUT} , should be placed between V_{OUT} and GND.

Note:

- The intrinsic diode for P-channel load switch would conduct if V_{OUT} is greater than V_{IN} , by a diode drop.

Evaluation Board Layout

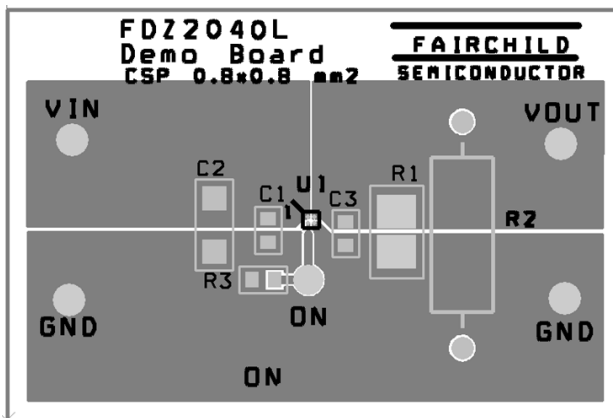

Figure 22. Top View

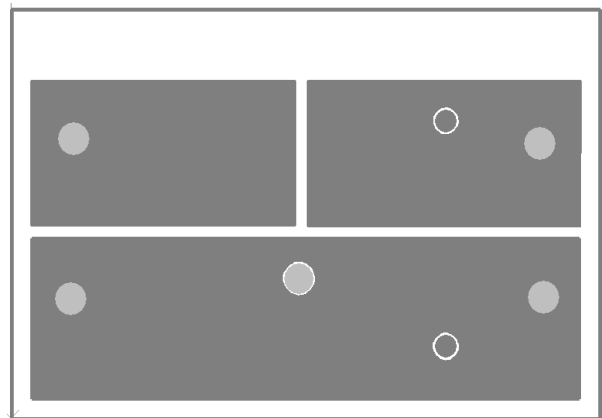
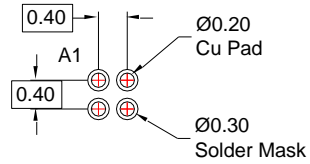
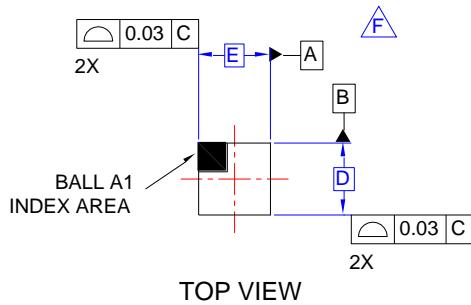
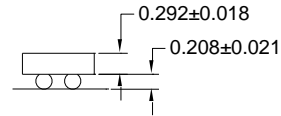
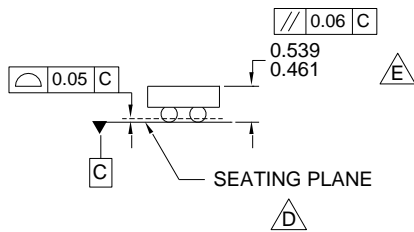

Figure 23. Bottom View

Physical Dimensions



RECOMMENDED LAND PATTERN
(NSMD PAD TYPE)



SIDE VIEWS

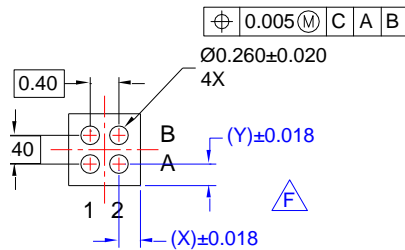

BOTTOM VIEW

NOTES:

- A. NO JEDEC REGISTRATION APPLIES.
- B. DIMENSIONS ARE IN MILLIMETERS.
- C. DIMENSIONS AND TOLERANCE PER ASME Y14.5M, 1994.
- D. DATUM C IS DEFINED BY THE SPHERICAL CROWNS OF THE BALLS.
- E. PACKAGE NOMINAL HEIGHT IS 500 MICRONS ± 39 MICRONS (461-539 MICRONS).
- F. FOR DIMENSIONS D, E, X, AND Y SEE PRODUCT DATASHEET.
- G. DRAWING FILNAME: MKT-UC004AFrev1.

Figure 24. 4 Ball, WLCSP, 2 X 2 Array, 0.4 mm Pitch, 250 μ m Ball

Product-Specific Dimensions





Product	D	E	X	Y
FDZ22040L	0.8 \pm 0.03 mm	0.8 \pm 0.03 mm	0.21 mm	0.21 mm

Package drawings are provided as a service to customers considering Fairchild components. Drawings may change in any manner without notice. Please note the revision and/or date on the drawing and contact a Fairchild Semiconductor representative to verify or obtain the most recent revision. Package specifications do not expand the terms of Fairchild's worldwide terms and conditions, specifically the warranty therein, which covers Fairchild products.

Always visit Fairchild Semiconductor's online packaging area for the most recent package drawings:
<http://www.fairchildsemi.com/packaging/>

TRADEMARKS

The following includes registered and unregistered trademarks and service marks, owned by Fairchild Semiconductor and/or its global subsidiaries, and is not intended to be an exhaustive list of all such trademarks.

- | | | | |
|---|--|---|---|
| 2Cool™ | FPS™ |  | Sync-Lock™ |
| AccuPower™ | F-PFS™ | PowerTrench® |  |
| AX-CAP SM * | FRFET® | PowerXS™ | TinyBoost™ |
| BitSiC™ | Global Power Resource SM | Programmable Active Droop™ | TinyBuck™ |
| Build it Now™ | GreenBridge™ | QFET® | TinyCalc™ |
| CorePLUS™ | Green FPS™ | QS™ | TinyLogic® |
| CorePOWER™ | Green FPS™ e-Series™ | Quiet Series™ | TINYOPTO™ |
| CROSSVOLT™ | Gmax™ | RapidConfigure™ | TinyPower™ |
| CTL™ | GTO™ |  | TinyPWM™ |
| Current Transfer Logic™ | IntelliMAX™ | Saving our world, 1mW/W/kW at a time™ | TinyWire™ |
| DEUXPEED® | ISOPLANAR™ | SignalWise™ | TransiC™ |
| Dual Cool™ | Making Small Speakers Sound Louder and Better™ | SmartMax™ | TriFault Detect™ |
| EcoSPARK® | MegaBuck™ | SMART START™ | TRUECURRENT®* |
| EfficientMax™ | MICROCOUPLER™ | Solutions for Your Success™ | μSerDes™ |
| ESBC™ | MicroFET™ | SPM® |  |
|  | MicroPak™ | STEALTH™ | UHC® |
| Fairchild® | MicroPak2™ | SuperFET® | Ultra FRFET™ |
| Fairchild Semiconductor® | MillerDrive™ | SuperSOT™-3 | UniFET™ |
| FACT Quiet Series™ | MotionMax™ | SuperSOT™-6 | VCX™ |
| FACT® | mWSaver™ | SuperSOT™-8 | VisualMax™ |
| FAST® | OptoHiT™ | SupreMOS® | VoltagePlus™ |
| FastvCore™ | OPTOLOGIC® | SyncFET™ | XS™ |
| FETBench™ | OPTOPLANAR® | | |

* Trademarks of System General Corporation, used under license by Fairchild Semiconductor.

DISCLAIMER

FAIRCHILD SEMICONDUCTOR RESERVES THE RIGHT TO MAKE CHANGES WITHOUT FURTHER NOTICE TO ANY PRODUCTS HEREIN TO IMPROVE RELIABILITY, FUNCTION, OR DESIGN. FAIRCHILD DOES NOT ASSUME ANY LIABILITY ARISING OUT OF THE APPLICATION OR USE OF ANY PRODUCT OR CIRCUIT DESCRIBED HEREIN; NEITHER DOES IT CONVEY ANY LICENSE UNDER ITS PATENT RIGHTS, NOR THE RIGHTS OF OTHERS. THESE SPECIFICATIONS DO NOT EXPAND THE TERMS OF FAIRCHILD'S WORLDWIDE TERMS AND CONDITIONS, SPECIFICALLY THE WARRANTY THEREIN, WHICH COVERS THESE PRODUCTS.

LIFE SUPPORT POLICY

FAIRCHILD'S PRODUCTS ARE NOT AUTHORIZED FOR USE AS CRITICAL COMPONENTS IN LIFE SUPPORT DEVICES OR SYSTEMS WITHOUT THE EXPRESS WRITTEN APPROVAL OF FAIRCHILD SEMICONDUCTOR CORPORATION.

As used herein:

1. Life support devices or systems are devices or systems which, (a) are intended for surgical implant into the body or (b) support or sustain life, and (c) whose failure to perform when properly used in accordance with instructions for use provided in the labeling, can be reasonably expected to result in a significant injury of the user.
2. A critical component in any component of a life support, device, or system whose failure to perform can be reasonably expected to cause the failure of the life support device or system, or to affect its safety or effectiveness.

ANTI-COUNTERFEITING POLICY

Fairchild Semiconductor Corporation's Anti-Counterfeiting Policy. Fairchild's Anti-Counterfeiting Policy is also stated on our external website, www.fairchildsemi.com, under Sales Support.

Counterfeiting of semiconductor parts is a growing problem in the industry. All manufacturers of semiconductor products are experiencing counterfeiting of their parts. Customers who inadvertently purchase counterfeit parts experience many problems such as loss of brand reputation, substandard performance, failed applications, and increased cost of production and manufacturing delays. Fairchild is taking strong measures to protect ourselves and our customers from the proliferation of counterfeit parts. Fairchild strongly encourages customers to purchase Fairchild parts either directly from Fairchild or from Authorized Fairchild Distributors who are listed by country on our web page cited above. Products customers buy either from Fairchild directly or from Authorized Fairchild Distributors are genuine parts, have full traceability, meet Fairchild's quality standards for handling and storage and provide access to Fairchild's full range of up-to-date technical and product information. Fairchild and our Authorized Distributors will stand behind all warranties and will appropriately address any warranty issues that may arise. Fairchild will not provide any warranty coverage or other assistance for parts bought from Unauthorized Sources. Fairchild is committed to combat this global problem and encourage our customers to do their part in stopping this practice by buying direct or from authorized distributors.

PRODUCT STATUS DEFINITIONS

Definition of Terms

Datasheet Identification	Product Status	Definition
Advance Information	Formative / In Design	Datasheet contains the design specifications for product development. Specifications may change in any manner without notice.
Preliminary	First Production	Datasheet contains preliminary data; supplementary data will be published at a later date. Fairchild Semiconductor reserves the right to make changes at any time without notice to improve design.
No Identification Needed	Full Production	Datasheet contains final specifications. Fairchild Semiconductor reserves the right to make changes at any time without notice to improve the design.
Obsolete	Not In Production	Datasheet contains specifications on a product that is discontinued by Fairchild Semiconductor. The datasheet is for reference information only.

Rev. 164

ON Semiconductor and  are trademarks of Semiconductor Components Industries, LLC dba ON Semiconductor or its subsidiaries in the United States and/or other countries. ON Semiconductor owns the rights to a number of patents, trademarks, copyrights, trade secrets, and other intellectual property. A listing of ON Semiconductor's product/patent coverage may be accessed at www.onsemi.com/site/pdf/Patent-Marking.pdf. ON Semiconductor reserves the right to make changes without further notice to any products herein. ON Semiconductor makes no warranty, representation or guarantee regarding the suitability of its products for any particular purpose, nor does ON Semiconductor assume any liability arising out of the application or use of any product or circuit, and specifically disclaims any and all liability, including without limitation special, consequential or incidental damages. Buyer is responsible for its products and applications using ON Semiconductor products, including compliance with all laws, regulations and safety requirements or standards, regardless of any support or applications information provided by ON Semiconductor. "Typical" parameters which may be provided in ON Semiconductor data sheets and/or specifications can and do vary in different applications and actual performance may vary over time. All operating parameters, including "Typicals" must be validated for each customer application by customer's technical experts. ON Semiconductor does not convey any license under its patent rights nor the rights of others. ON Semiconductor products are not designed, intended, or authorized for use as a critical component in life support systems or any FDA Class 3 medical devices or medical devices with a same or similar classification in a foreign jurisdiction or any devices intended for implantation in the human body. Should Buyer purchase or use ON Semiconductor products for any such unintended or unauthorized application, Buyer shall indemnify and hold ON Semiconductor and its officers, employees, subsidiaries, affiliates, and distributors harmless against all claims, costs, damages, and expenses, and reasonable attorney fees arising out of, directly or indirectly, any claim of personal injury or death associated with such unintended or unauthorized use, even if such claim alleges that ON Semiconductor was negligent regarding the design or manufacture of the part. ON Semiconductor is an Equal Opportunity/Affirmative Action Employer. This literature is subject to all applicable copyright laws and is not for resale in any manner.

PUBLICATION ORDERING INFORMATION

LITERATURE FULFILLMENT:

Literature Distribution Center for ON Semiconductor
19521 E. 32nd Pkwy, Aurora, Colorado 80011 USA
Phone: 303-675-2175 or 800-344-3860 Toll Free USA/Canada
Fax: 303-675-2176 or 800-344-3867 Toll Free USA/Canada
Email: orderlit@onsemi.com

N. American Technical Support: 800-282-9855 Toll Free
USA/Canada
Europe, Middle East and Africa Technical Support:
Phone: 421 33 790 2910
Japan Customer Focus Center
Phone: 81-3-5817-1050

ON Semiconductor Website: www.onsemi.com
Order Literature: <http://www.onsemi.com/orderlit>
For additional information, please contact your local
Sales Representative