

GPS+LTE Combination Antenna JCB046L

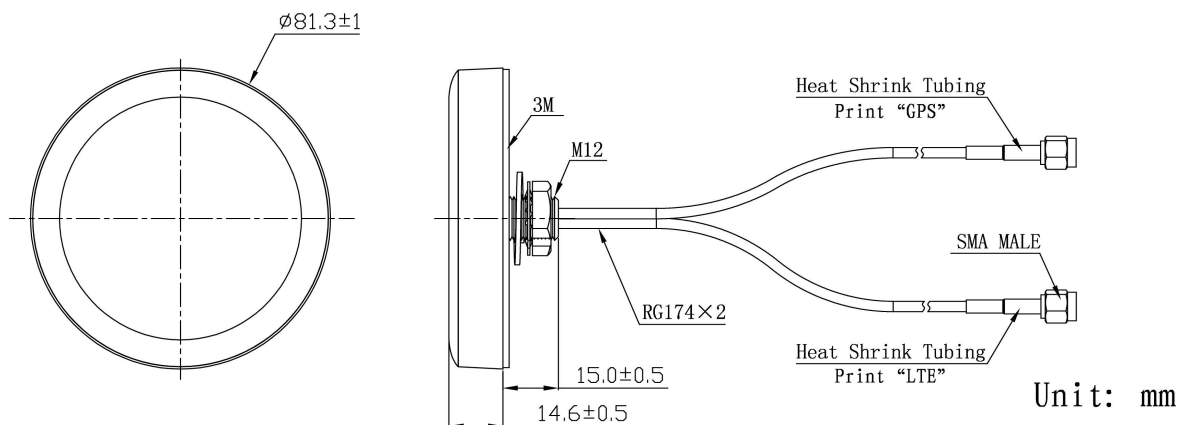

DIMENSIONS



SPECIFICATIONS

Item		Specifications	
GPS Antenna	Dielectric Antenna	Frequency Range	1575.42 ± 3MHz
		Polarization	RHCP
		Gain	2dBic (Zenith)
		V.S.W.R	<1.5
		Impedance	50Ω
	LNA	Gain	28±2dB
		Noise Figure	<2dB
		V.S.W.R	<2.0
		Supply Voltage	3~5V DC
		Current Consumption	<20mA
LTE Antenna	Frequency Range	698~960MHz/1710~2690MHz	
	V.S.W.R	<3.0	
	Polarization	Linear	
	Gain	2.5dBi	
	Impedance	50Ω	
Mechanical	Cable	RG174	
	Connector	SMA or others	
	Material	ABS	
	Mounting Method	Screw	
Environmental	Operating Temperature	-40°C~+85°C	
	Relative Humidity	Up to 95%	
	Ingress Protection	IP67 (exclude cable outlet)	
	Vibration	10 to 55Hz with 1.5mm amplitude 2hours	
	Environmentally Friendly	ROHS Compliant	

Radiation Pattern

GPS Antenna

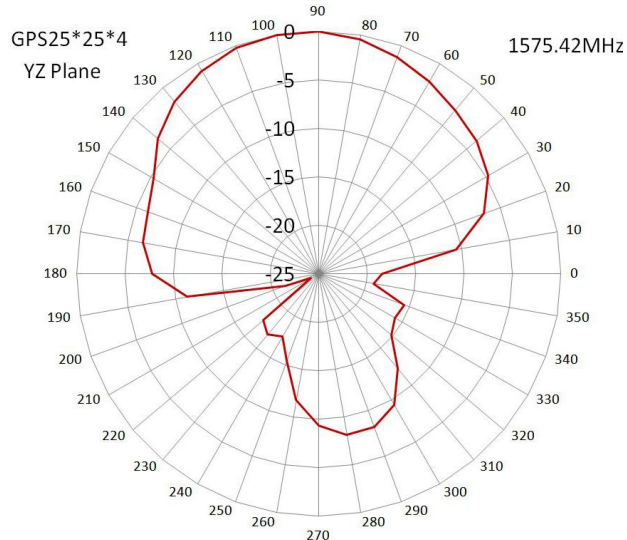
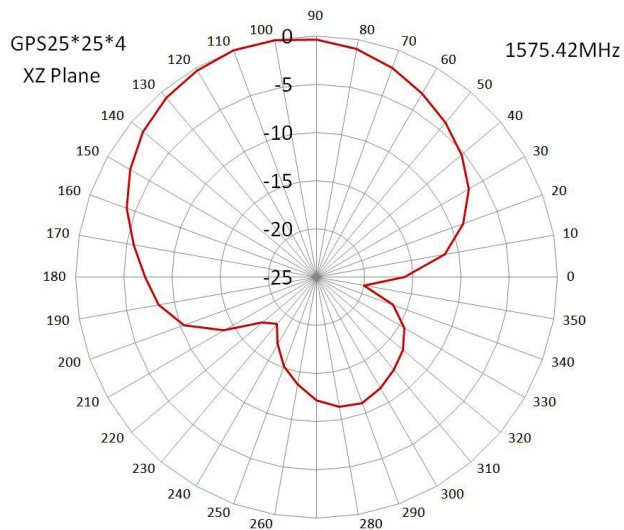
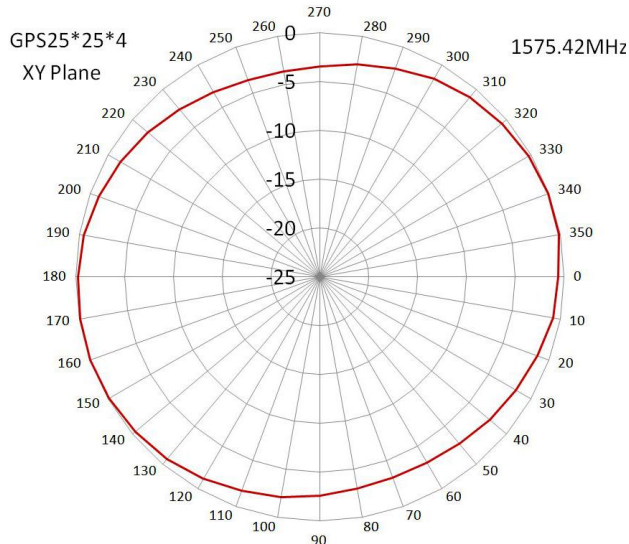

JIAXING JINCHANG ELECTRONIC TECHNOLOGY CO.,LTD

Add: 398#,Zhenye Road, South Street, Jiaxing, Zhejiang, China

Http:// www.jinchanggps.com

E-mail:jcgps@vip.163.com

Tel: 86-0573-83692157/83692605/83958637 Fax:86-0573-83958635

LTE Antenna

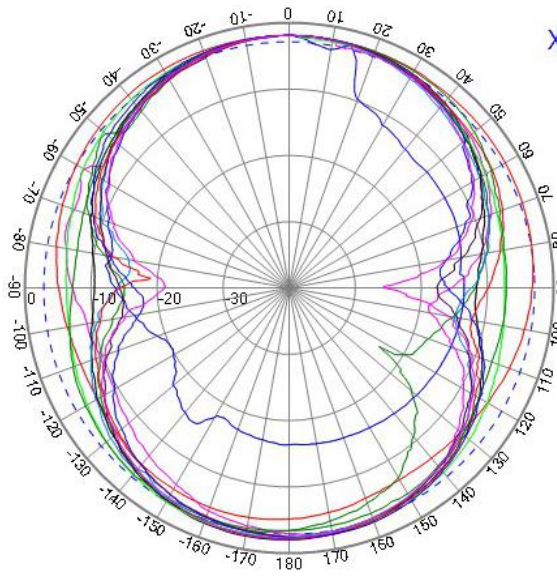

XY PLANE

- Freq: 700
- Freq: 824
- Freq: 868
- Freq: 960
- Freq: 1710
- Freq: 1850
- Freq: 1990
- Freq: 2170
- Freq: 2300
- Freq: 2400
- Freq: 2500
- Freq: 2690

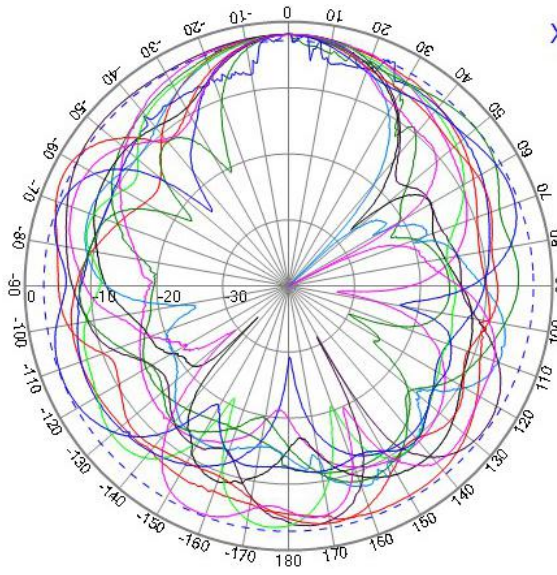

XZ PLANE

- Freq: 700
- Freq: 824
- Freq: 868
- Freq: 960
- Freq: 1710
- Freq: 1850
- Freq: 1990
- Freq: 2170
- Freq: 2300
- Freq: 2400
- Freq: 2500
- Freq: 2690

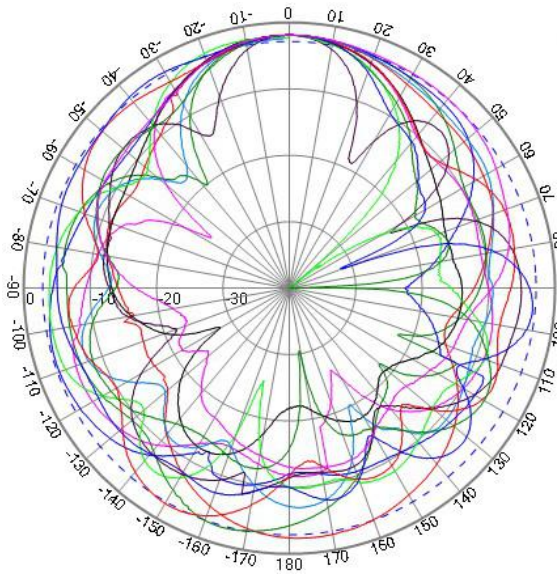

YZ PLANE

- Freq: 700
- Freq: 824
- Freq: 868
- Freq: 960
- Freq: 1710
- Freq: 1850
- Freq: 1990
- Freq: 2170
- Freq: 2300
- Freq: 2400
- Freq: 2500
- Freq: 2690