

MU-2W SERIES

2W UNREGULATED

DANUBE

FEATURES

- SINGLE IN LINE PACKAGE
- UP TO 2W UNREGULATED OUTPUT POWER
- 100% BURN IN
- HIGH EFFICIENCY
- INTERNAL SMD TECHNOLOGY
- LOW COST
- NO HEATSINK REQUIRED
- UL 94V-0 PACKAGE MATERIAL
- CUSTOM SOLUTIONS AVAILABLE
- RoHS COMPLIANT
- 3 YEARS WARRANTY

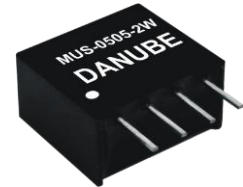

OUTPUT SPECIFICATIONS

Voltage Set-point Accuracy	+/-2% max.
Temperature Coefficient	+/-0.05%/°C
Ripple & Noise (20MHz BW) ¹	100mVp-p max.
Line Regulation ²	+/-1.2% max.
Load Regulation ³	+/-8% max.
Minimum Load	10% of Full Load
Short Circuit Protection	Momentary

INPUT SPECIFICATIONS

Input Voltage Range	+/-10% max.
Input Filter	Capacitor typ.
Protection	Fuse Recommended

ENVIRONMENTAL SPECIFICATIONS

Operating Temperature	-40 °C to +71 °C
Storage Temperature	-55 °C to +125 °C
Humidity	95% max.
Cooling	Free-Air Convection

GENERAL SPECIFICATIONS

Efficiency	77%-85%
Isolation Voltage ⁴	1500VDC min.
Isolation Resistance	10 ⁹ ohms min.
Isolation Capacitance	80pF max.
Switching Frequency	100KHz min.
MTBF ⁵	>1,100,000 Hours
Weight	1.3g typ.
Case Material	Non-Conductive Plastic
Case Size	11.7mm*7.5mm*10.1mm
Radiated Emissions	EN55022 Class B

ALL SPECIFICATIONS TYPICAL AT NOMINAL LINE, FULL LOAD AND 25 °C UNLESS OTHERWISE NOTED.

¹ Measured with 1uF ceramic capacitor connects to the output pins.

² Line Regulation is for a 1.0% change in input Voltage.

³ Load Regulation is for output load current change from 20% to 100%.

⁴ 1500 For 10 seconds.

⁵ MIL-HDBK-217F @25 °C , Ground Benign.

● **SELECTION GUIDE**
2W OUTPUT

MODEL NUMBER	INPUT VOLTAGE (VDC)	OUTPUT VOLTAGE (VDC)	OUTPUT CURRENT (mA)	INPUT ⁶ CURRENT(mA)		EFF (%) ⁷	ISOLATION (VDC)
				FULL LOAD	NO LOAD		
				MUS-0505-2W	5		
MUS-0512-2W	5	12	167	500	55	80	1500
MUS-0515-2W	5	15	133	488	55	82	1500
MUS-1205-2W	12	5	400	214	16	78	1500
MUS-1212-2W	12	12	167	207	16	81	1500
MUS-1215-2W	12	15	133	203	16	82	1500
MUS-2405-2W	24	5	400	107	15	78	1500
MUS-2412-2W	24	12	167	103	15	81	1500
MUS-2415-2W	24	15	133	101	15	82	1500

Note: Other input to output voltages may be available. Please contact factory.

⁶ NOMINAL INPUT VOLTAGE.

⁷ NOMINAL INPUT VOLTAGE, FULL LOAD.

MECHANICAL DIMENSIONS & RECOMMENDED FOOTPRINT DETAILS

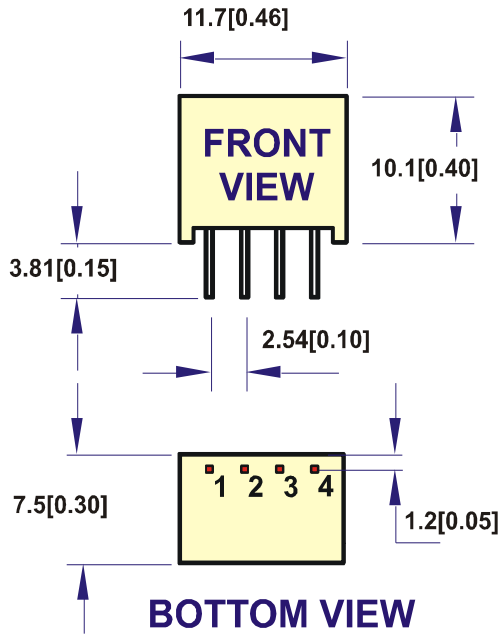

PIN	SINGLE
1	-Vin
2	+Vin
3	-Vout
4	+Vout

NOTE : All dimensions are in mm [inches]

1. Pin Size is 0.50x0.30mm[0.02x0.01"]

2. Pin is Tolerance .XX= ±0.05mm

3. Tolerance .X or .XX= ±0.5mm

All dimensions are in mm[inches]

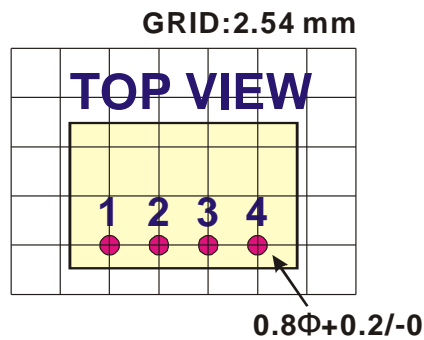

SIMPLIFIED SCHEMATIC

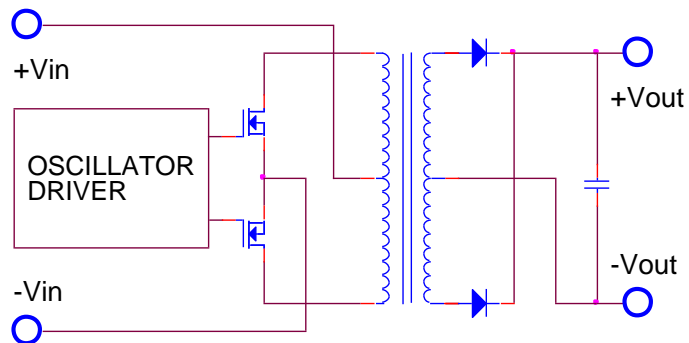

● TYPICAL APPLICATIONS

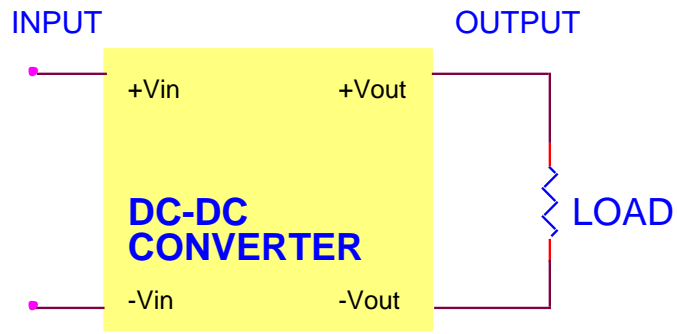

● TYPICAL PERFORMANCE CURVES

Specifications typical at TA=25 °C, nominal input voltage, rated output current unless otherwise specified.

VOUT VS LOAD (5Vout Models)

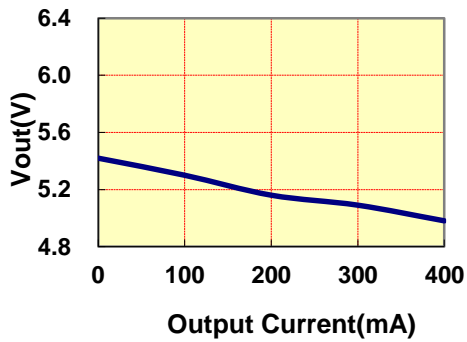

VOUT VS LOAD (12Vout Models)

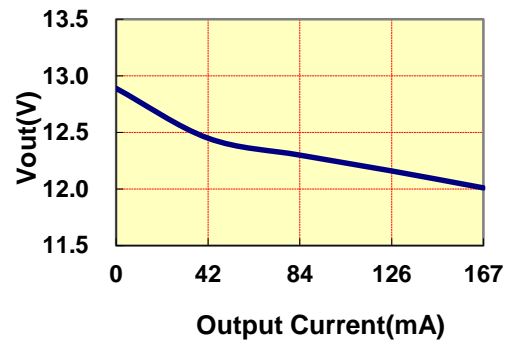

VOUT VS LOAD (15Vout Models)

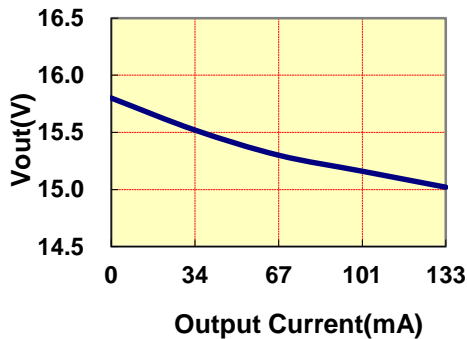

DERATING CURVE

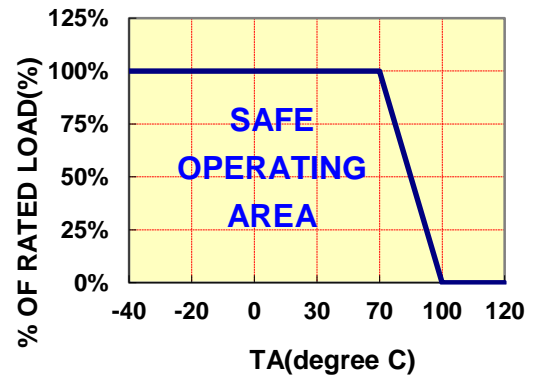

EFFICIENCY VS LOAD

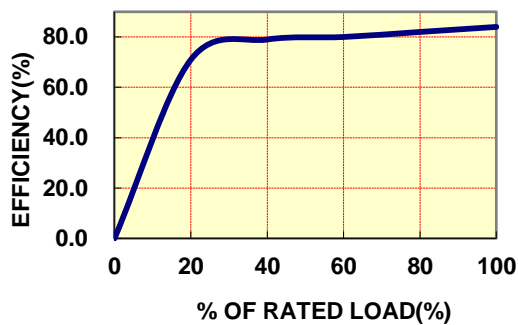

● INPUT FUSE SELECTION GUIDE

4.5-5.5V INPUT VOLTAGE(VDC)	10.8-13.2V INPUT VOLTAGE(VDC)	21.6-26.4V INPUT VOLTAGE(VDC)
1500mA Slow-Blow Type	600mA Slow-Blow Type	300mA Slow-Blow Type

The diagram shows a yellow rectangular block labeled 'DC-DC CONVERTER'. On the left side, there are two terminals: '+Vin' (top) and '-Vin' (bottom). On the right side, there are two terminals: '+Vout' (top) and '-Vout' (bottom). A blue line labeled 'INPUT' enters from the left, passes through a component labeled 'Fuse' connected in series with the '+Vin' terminal, and then enters the '+Vin' terminal. A blue line labeled 'OUTPUT' exits from the right, connected to the '+Vout' terminal. The '-Vin' and '-Vout' terminals are also connected to blue lines.

Note: Certain applications may require the installation of external fuse in front of the input.

MU-2W SERIES APPLICATION NOTES:

EXTERNAL CAPACITANCE REQUIREMENTS:

Output filtering is required for operation. A minimum of 10uF is needed. Output capacitance may be increased for additional filtering, not to exceed 220uF.

To meet the reflected ripple requirements of the converter, an input impedance of less than 0.5ohm from DC to 250KHz is required.

We Can Offer EMC-Filter According To EN55011/22 Class B.

Negative Outputs:

A negative output voltage may be obtained by connecting the +OUT to circuit ground and connecting -OUT as the negative output.

FOR MORE INFORMATION CALL:

Danube Enterprise Co., Ltd.

Tel: 886-7-3755165

Fax: 886-7-3755330

E-mail: danube@ms10.hinet.net

Home Page

<http://www.danube.com.tw>
