

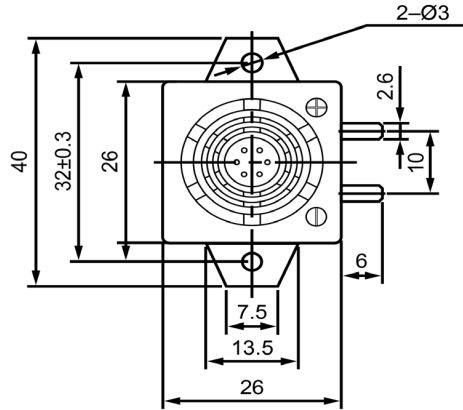

TOP VIEW

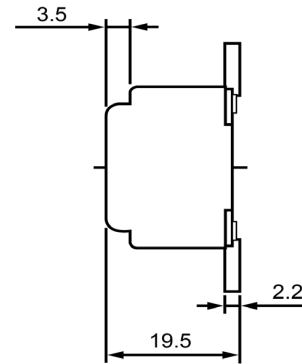

SIDE VIEW



Specifications			Notes	Revision History							
Description	Value	Unit		Version	Description		Date	Approved			
Technology	Electro-Mechanical		1) All dimensions are in mm unless otherwise noted 2) All parts meet RoHS	1	Released from Engineering		10/21/2013	J.S			
Resonant Frequency	400	(Hz)									
Rated Voltage	6	(V)									
SPL @ 10cm	95	(dBA)									
Tone	Single										
Mount Type	Flange Mount										
Voltage Range	4 ~ 8	(V)									
Max Rated Current	65	(mA)									
Housing Material	ABS										
Operating Temperature	-20 ~ +60	°C									
Storage Temperature	-30 ~ +70	°C									
Weight	17	(g)									
 DB UNLIMITED			 DB UNLIMITED			Electro-Mechanical Indicator			IE260406-2		
						Drawn by A.B.	Date 10/21/2013	Checked by C.E.	Date 10/21/2013	Approved by J.S	Date 10/21/2013

Additional considerations can be found at www.dbunlimitedco.com/technical-articles.