

LOC	DIST	REVISIONS					
E	B	P	LTR	DESCRIPTION	DATE	DWN	APVD
			BA	NEW RELEASE	08SEP2010	PT	St.P

FOR FURTHER INFORMATION SEE DATA SHEET FOR
RN73 SERIES-HIGH PRECISION RESISTORS (SMD)

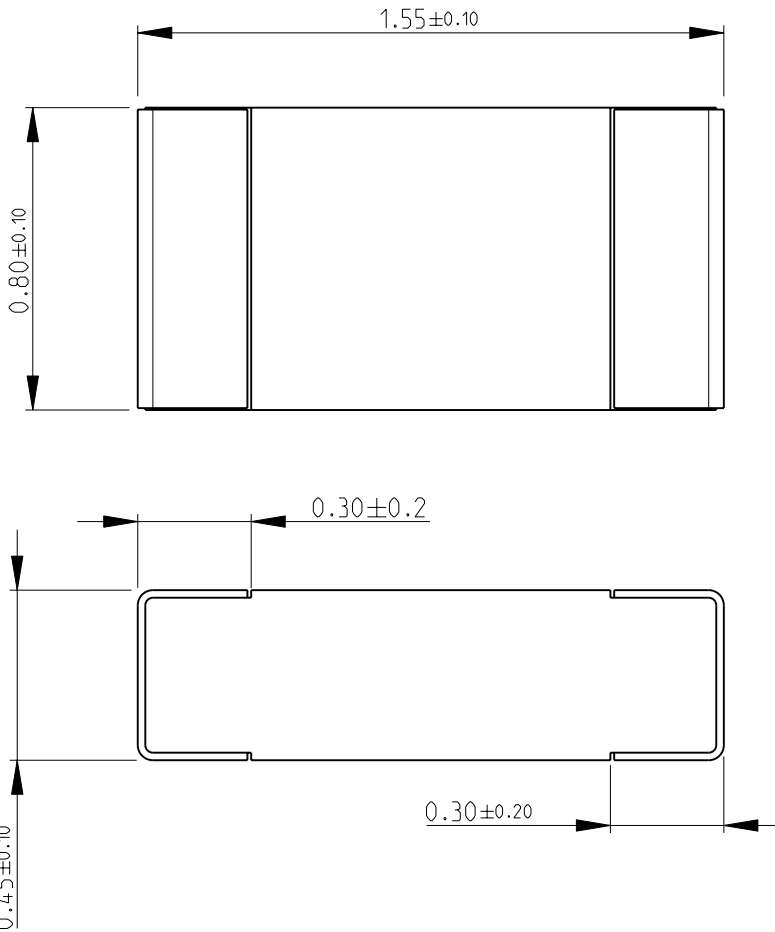

RECOMMENDED LAND PATTERN

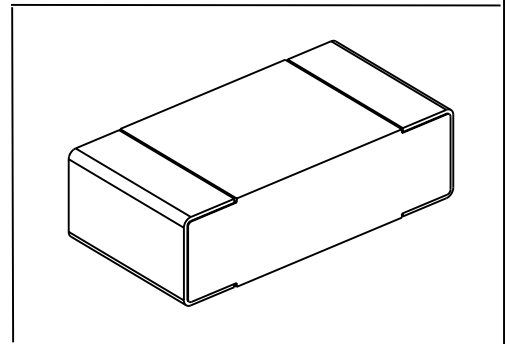
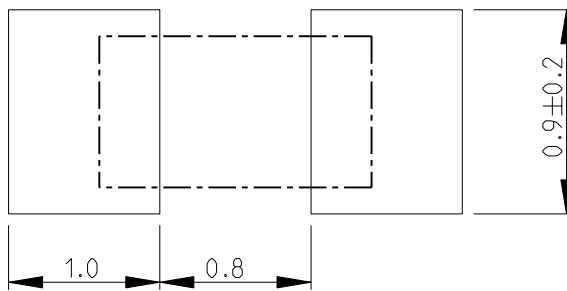

2010
 RELEASED FOR PUBLICATION
 THIS DRAWING IS UNPUBLISHED.
 COPYRIGHT 2010 BY TYCO ELECTRONICS CORPORATION. ALL RIGHTS RESERVED.

DIMENSIONS: mm	DWN	PARUSURAM.T	08SEP2010	MATERIAL	-	FINISH	-
	CHK	ALLAN.P	08SEP2010	Tyco Electronics Corporation Dorcan, Swindon, SN3 5HH			
TOLERANCES UNLESS OTHERWISE SPECIFIED:	APVD	STEPHEN.P	08SEP2010				
0 PLC ± 0.2	PRODUCT SPEC	-	-	NAME HIGH PRECISION RESISTORS (SMD) SERIES RN73 1J			
1 PLC ± 0.1	APPLICATION SPEC	-	-	SIZE	CAGE CODE	DRAWING NO	RESTRICTED TO
2 PLC \pm				A 4	00779	© = 1879134	-
3 PLC \pm				SCALE 20:1 SHEET 1 OF 1 REV BA			
4 PLC \pm				CUSTOMER DRAWING			
ANGLES $\pm 5^\circ$	WEIGHT	-	-				