

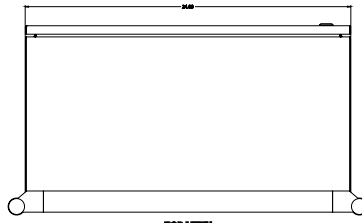

PART No. ECP202412

for more information visit
www.hammfg.com
Data subject to change without notice
Isometric drawing Not to Scale



TOP VIEW

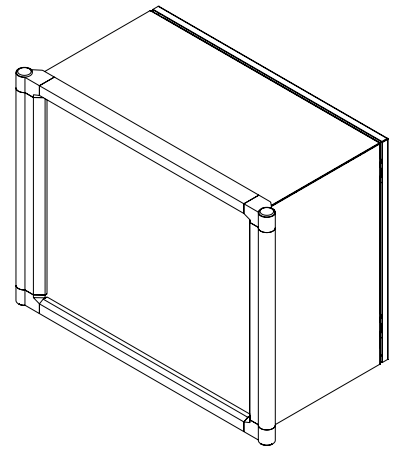

ISOMETRIC VIEW

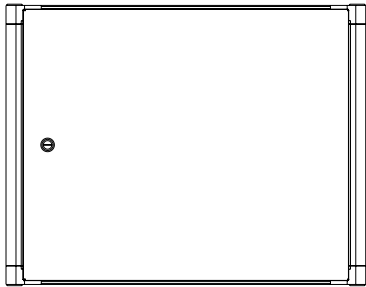

BACK VIEW

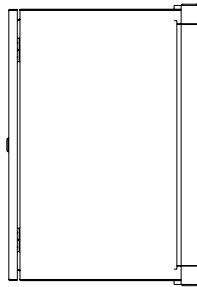

SIDE VIEW

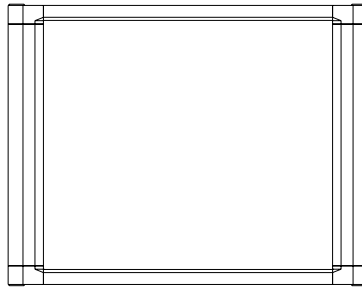

FRONT VIEW

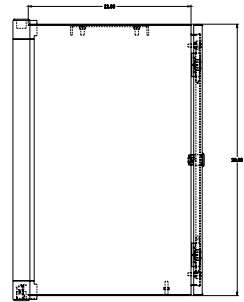

SIDE VIEW

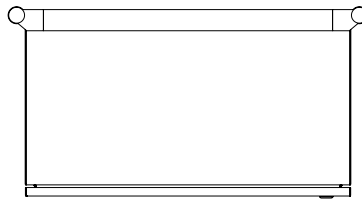

BOTTOM VIEW