

Item description

Male connector/plug *WINSTA*® MIDI with protection against mismatching

The *WINSTA*® MIDI male connector/plug with protection type IP20 supports fast, reliable installation. WAGO pluggable installation connectors are used when criteria repeat or are planned on a specific pattern, for example for installing grid lighting or flush-mount lighting. The coding options reduce installation errors, allowing fast, maintenance-free wiring of all components. The pluggable installation connector is protected in accordance with protection type IP20 (When mated and secured with a strain relief housing: IP2xC (These compact connectors are not designed for use in open, easily accessible areas!)). This means that users' fingers will never come into contact with energised elements. B coding enables the *WINSTA*® MIDI pluggable installation connectors to be used for control in applications in automation, robotics, and mechanical engineering. This pluggable installation connector is designed for a current load of up to 25 A. As a result, it can also be used for high power loads. *WINSTA*® MIDI with Push-in CAGE CLAMP® spring pressure connection technology is used in a broad range of individual products you can use for quick, easy, flexible, and secure electrical installation.

Subject to changes. Please also observe the further product documentation!



Lower costs through fast commissioning and elimination of service expenses – solutions from WINSTA® MIDI

WINSTA® is the pluggable connection system that is ideally tailored to the strict requirements of electrical installation. It ensures fast, secure and, above all, error-free installation of components and cables. Enjoy the benefits of the pluggable version of our maintenance-free spring pressure connection technology too! Plan your installation with WINSTA® MIDI pluggable installation connectors with marking from WAGO.

- protection against mismatching eliminates errors
- simple circuits
- for automation controllers
- ready to install and use immediately
- rapid, structured electrical installation

Data

Notes

Variants:

Other pole markings

Other versions (or variants) can be requested from WAGO Sales or configured at <https://configurator.wago.com/>.

Electrical data

Ratings per IEC/EN

Ratings per	IEC/EN 60664-1
Nominal voltage (III/3)	250 V
Rated impulse voltage (III/3)	4 kV
Rated current	25 A
Legend (ratings)	(III / 3) ≙ Overvoltage category III / Pollution degree 3

Ratings per UL 1977

Note for the US market

Some versions may also be used for current interruption in accordance with the UL certificate in select applications with currents below 16 A and voltages up to 600 V. For further information, please contact your local sales office.

Rated voltage (UL 1977)	600 V
Rated current UL 1977	23 A

Subject to changes. Please also observe the further product documentation!

WAGO GmbH & Co. KG

Hansastr. 27

32423 Minden

Phone: +49571 887-0 | Fax: +49571 887-169

Email: info.de@wago.com | Web: www.wago.com

Do you have any questions about our products?

We are always happy to take your call at +49 (571) 887-44222.



General

Note on contact resistance	approx. 1 mΩ of contact resistance approx. 0.25 mΩ contact transition plug/socket
----------------------------	--

Connection data

Connection points	6
Total number of potentials	3

Connection 1

Connection technology	Push-in CAGE CLAMP®
Actuation type	Operating tool Push-in
Nominal cross-section	4 mm ² / 12 AWG
Solid conductor	0.5 ... 4 mm ² / 20 ... 12 AWG
Solid conductor; push-in termination	1.5 ... 4 mm ² / 16 ... 12 AWG
Stranded conductor	0.5 ... 2.5 mm ² / 20 ... 14 AWG
Fine-stranded conductor	0.5 ... 4 mm ² / 20 ... 12 AWG
Fine-stranded conductor; with insulated ferrule	0.25 ... 1.5 mm ² / 20 ... 16 AWG
Fine-stranded conductor; with uninsulated ferrule	0.25 ... 2.5 mm ² / 20 ... 14 AWG
Fine-stranded conductor; with ferrule; push-in termination	1.5 mm ² / 16 AWG
Strip length	9 mm / 0.35 inches
Pole number	3
Conductor entry direction to mating direction	0°

Physical data

Pin spacing	10 mm / 0.394 inches
Width	30 mm / 1.181 inches
Height	12.9 mm / 0.508 inches
Depth	37.5 mm / 1.476 inches

Mechanical Data

Application	Control technology
Coding	B
Variable coding	Yes
Marking	5 2 1

Subject to changes. Please also observe the further product documentation!

WAGO GmbH & Co. KG
Hansastr. 27
32423 Minden
Phone: +49571 887-0 | Fax: +49571 887-169
Email: info.de@wago.com | Web: www.wago.com

Do you have any questions about our products?
We are always happy to take your call at +49 (571) 887-44222.



Potential marking	5 2 1
Mating force of a plug-in connection	approx. 20 ... 70 N (depending on pole number)
Retention force of a plug-in connection	Locked: > 80 N
Unmating force of a plug-in connection	Unlocked: approx. 20 ... 70 N (depending on pole number)
Number of mating cycles	200, without resistive load
Protection type	IP20; When mated and secured with a strain relief housing: IP2xC (These compact connectors are not designed for use in open, easily accessible areas!)

Plug-in connection

Contact type (pluggable connector)	Male connector/plug
Connector (connection type)	for conductor
Mismating protection	Yes
Note on mismating protection	All <i>WINSTA</i> [®] components are 100% protected against mismating when: a.) plugging different numbers of poles b.) plugging while rotated 180 c.) plugging while laterally staggered d.) plugging one pole
Locking lever	Can be retrofitted
Locking of plug-in connection	locking lever
Note on locking system	All connectors for mounted installations (snap-in versions for lighting fixtures or devices, all types of PCB and distribution connectors) are factory-equipped with locking levers to ensure plugs and sockets are securely locked. Additional locking levers are only required for flying leads (plug/socket).

Material Data

Note (material data)	Information on material specifications can be found here
Color	pink
Cover color	gray
Material group	I
Insulation material	Polyamide (PA66)
Flammability class per UL94	V0
Clamping spring material	Chrome-nickel spring steel (CrNi)
Contact material	Copper or copper alloy; surface-treated
Contact plating	Tin
Fire load	0.212 MJ

Subject to changes. Please also observe the further product documentation!

Weight	10 g
--------	------

Environmental requirements

Processing temperature	-5 ... +40 °C
Continuous operating temperature	-35 ... +85 °C
Note on continuous operating temperature	Insulating parts for temperatures ≤ 105 °C

Commercial data

eCl@ss 10.0	27-44-06-05
eCl@ss 9.0	27-44-06-05
ETIM 8.0	EC002560
ETIM 7.0	EC002560
PU (SPU)	100 pcs
Packaging type	box
Country of origin	DE
GTIN	4050821553472
Customs tariff number	85366990990

Environmental Product Compliance

RoHS Compliance Status	Compliant, No Exemption
------------------------	-------------------------

Approvals / Certificates

General approvals

Logo	Approval	Additional Approval Text	Certificate name
	cURus Underwriters Laboratories Inc.	UL 1977	E45171

Counterpart



Item no. 770-283/081-000
Socket; 3-pole; Cod. B; 4,00 mm²; pink

www.wago.com/770-283/081-000

Subject to changes. Please also observe the further product documentation!



Item no. 770-783/081-000
Snap-in socket; 3-pole; Cod. B; 4,00 mm²; pink

www.wago.com/770-783/081-000



Item no. 770-883/011-000/081-000
Socket for PCBs; angled; 3-pole; Cod. B; pink

www.wago.com/770-883/011-000/081-000



Item no. 770-883/081-000
Socket for PCBs; straight; 3-pole; Cod. B; pink

www.wago.com/770-883/081-000

Required accessories

Locking levers

Locking system



Item no.: 770-121
Locking lever; for flying leads; for manual operation; white

www.wago.com/770-121



Item no.: 770-131
Locking lever; for flying leads; for tool operation; white

www.wago.com/770-131



Item no.: 770-101
Locking lever; for flying leads; for manual operation; black

www.wago.com/770-101



Item no.: 770-111
Locking lever; for flying leads; for tool operation; black

www.wago.com/770-111

Optional accessories

Strain relief

Strain relief housing



Item no.: 770-503
Strain relief housing; 3-pole; for 2 cables; 8.0 ... 11.5 mm; 55 mm; black

www.wago.com/770-503



Item no.: 770-503/023-000
Strain relief housing; 3-pole; for 2 cables; 4.5 ... 8.0 mm; 55 mm; black

www.wago.com/770-503/023-000



Item no.: 770-503/021-000
Strain relief housing; 3-pole; for 1 cable; 9.0 ... 13.0 mm; 71 mm; black

www.wago.com/770-503/021-000



Item no.: 770-503/035-000
Strain relief housing; 3-pole; with locking clip; for 1 cable; 7.0 ... 11.5 mm; 48 mm; black

www.wago.com/770-503/035-000

Subject to changes. Please also observe the further product documentation!

WAGO GmbH & Co. KG

Hansastr. 27

32423 Minden

Phone: +49571 887-0 | Fax: +49571 887-169

Email: info.de@wago.com | Web: www.wago.com

Do you have any questions about our products?

We are always happy to take your call at +49 (571) 887-44222.



Item no.: 770-503/038-000

Strain relief housing; 3-pole; with locking clip; for 1 cable; 7.0 ... 11.5 mm; 48 mm; black

www.wago.com/770-503/038-000



Item no.: 770-503/032-000

Strain relief housing; 3-pole; with locking clip; for 2 cables; 8.0 ... 11.5 mm; 55 mm; black

www.wago.com/770-503/032-000



Item no.: 770-513/038-000

Strain relief housing; 3-pole; with locking clip; for 1 cable; 7.0 ... 11.5 mm; 48 mm; white

www.wago.com/770-513/038-000



Item no.: 770-513

Strain relief housing; 3-pole; for 2 cables; 8.0 ... 11.5 mm; 55 mm; white

www.wago.com/770-513



Item no.: 770-513/021-000

Strain relief housing; 3-pole; for 1 cable; 9.0 ... 13.0 mm; 71 mm; white

www.wago.com/770-513/021-000



Item no.: 770-513/032-000

Strain relief housing; 3-pole; for 2 cables; 8.0 ... 11.5 mm; 55 mm; white

www.wago.com/770-513/032-000



Item no.: 770-513/035-000

Strain relief housing; 3-pole; with locking clip; for 1 cable; 7.0 ... 11.5 mm; 48 mm; white

www.wago.com/770-513/035-000



Item no.: 770-513/023-000

Strain relief housing; 3-pole; for 2 cables; 4.5 ... 8.0 mm; 55 mm; white

www.wago.com/770-513/023-000

Marking accessories

Marker



Item no.: 770-450/000-002

Marker card; Plastic; yellow

www.wago.com/770-450/000-002



Item no.: 770-450/000-001

Marker card; Plastic; green

www.wago.com/770-450/000-001

Subject to changes. Please also observe the further product documentation!

WAGO GmbH & Co. KG

Hansastr. 27

32423 Minden

Phone: +49571 887-0 | Fax: +49571 887-169

Email: info.de@wago.com | Web: www.wago.com

Do you have any questions about our products?

We are always happy to take your call at +49 (571) 887-44222.



Item no.: 770-450/000-005
Marker card; Plastic; red

www.wago.com/770-450/000-005



Item no.: 770-450
Marker card; Plastic; white

www.wago.com/770-450



Item no.: 770-450/000-006
Marker card; Plastic; blue

www.wago.com/770-450/000-006



Item no.: 770-450/000-012
Marker card; Plastic; orange

www.wago.com/770-450/000-012

Tool

Operating tool



Item no.: 210-719
Operating tool; Blade: 2.5 x 0.4 mm; with a partially insulated shaft

www.wago.com/210-719



Item no.: 770-383
Operating tool; 3-way; green

www.wago.com/770-383

Coding

Coding



Item no.: 770-401
Coding pin; for plugs; Plastic; gray

www.wago.com/770-401

Cover

Cover



Item no.: 770-360
Lockout cap; for plugs; 5-pole; separable; yellow

www.wago.com/770-360

Mounting

Snap-in frame



Item no.: 770-318
Snap-in frame; 3-pole; 1.0 ... 3.0 mm; black

www.wago.com/770-318



Item no.: 770-338
Snap-in frame; 3-pole; 1.0 ... 3.0 mm; white

www.wago.com/770-338

Subject to changes. Please also observe the further product documentation!

WAGO GmbH & Co. KG

Hansastr. 27

32423 Minden

Phone: +49571 887-0 | Fax: +49571 887-169

Email: info.de@wago.com | Web: www.wago.com

Do you have any questions about our products?

We are always happy to take your call at +49 (571) 887-44222.



Downloads Documentation

Bid Text

770-293/081-000 X81 - Datei	2019 Feb 19	xml 3.0 kB	Download
770-293/081-000 doc - Datei	2015 Jun 8	doc 24.6 kB	Download

CAD/CAE-Data

CAE data

WSCAD Universe 770-293/081-000	URL	Download
ZUKEN Portal 770-293/081-000	URL	Download
WSCAD Universe 770-293/081-000	URL	Download

CAD data

2D/3D Models 770-293/081-000	URL	Download
------------------------------	-----	----------

Environmental Product Compliance

Compliance Search

Environmental Product Compliance 770-293/081-000 Plug; 3-pole; Cod. B; 4,00 mm ² ; pink	URL	Download
---	-----	----------

Installation Notes

Conductor termination

Subject to changes. Please also observe the further product documentation!

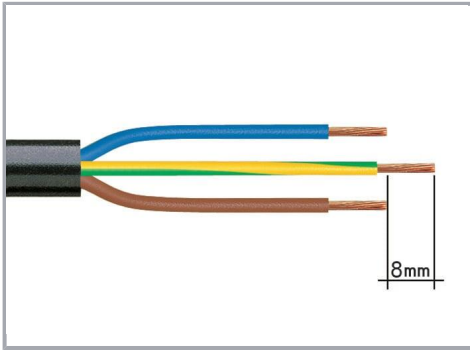

1. Strip length, outer insulation = 35 mm (2-pole), 55 mm (3- to 5-pole)
2. Strip length = 9 mm
3. Extended ground conductor = 8 mm

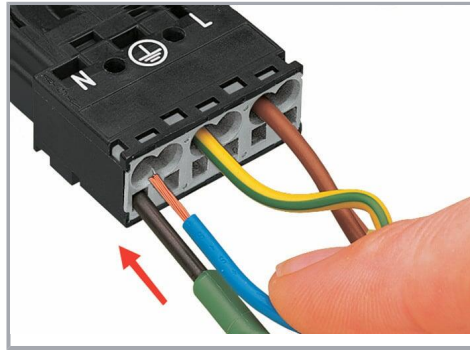

To terminate fine-stranded conductors, open the clamping unit via screwdriver (2.5 mm blade width) and insert a stripped conductor until it hits the backstop.

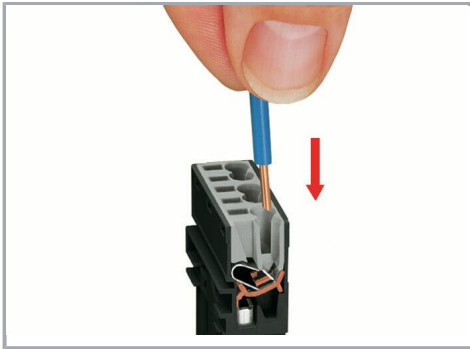

Insert the stripped solid conductor until it hits the backstop.

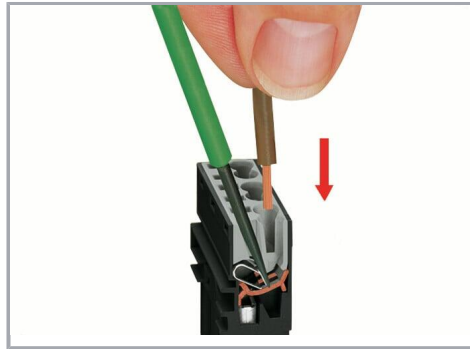

To terminate fine-stranded conductors, open the clamping unit via screwdriver (2.5 mm blade width) and insert a stripped conductor until it hits the backstop.

Conductor removal

Subject to changes. Please also observe the further product documentation!

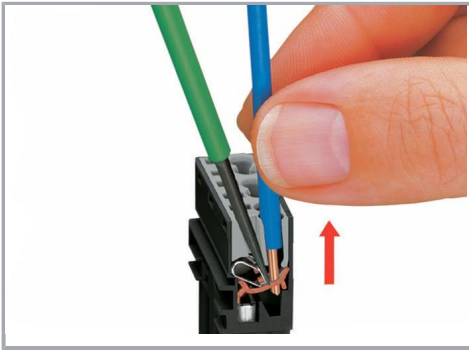

To remove the conductor, actuate the clamp via screwdriver (2.5 mm blade width) and pull out the conductor.

Installation

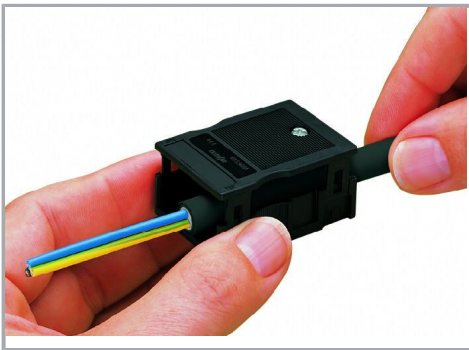

We recommend pulling the pre-latched strain relief housing over the cable prior to termination. However, the strain relief can be mounted at a later time as well.

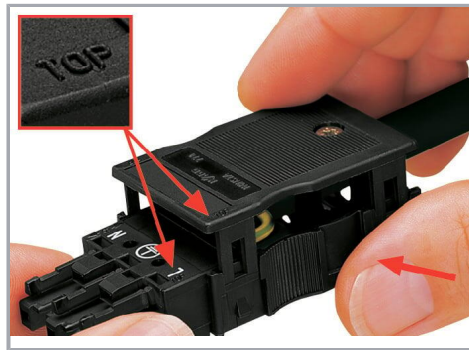

Latch the strain relief housing onto the plug /socket. Note the "TOP" inscription.

Subject to changes. Please also observe the further product documentation!

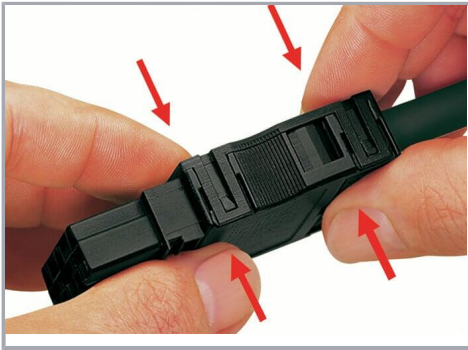

Prepare strain relief housing by snapping together upper and bottom part.



Tighten strain relief screw with screwdriver (2.5 mm blade width).

Coding



Simply cut off the coding pin from the socket.

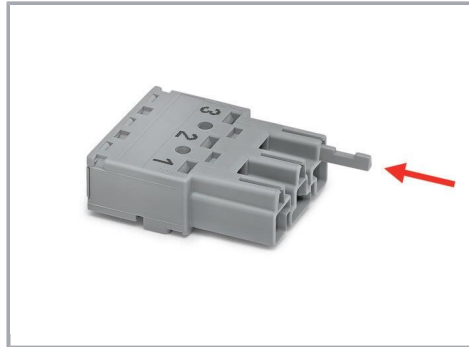

Insert coding pin into plug (break first) until it engages.

Mismatching protection

Subject to changes. Please also observe the further product documentation!

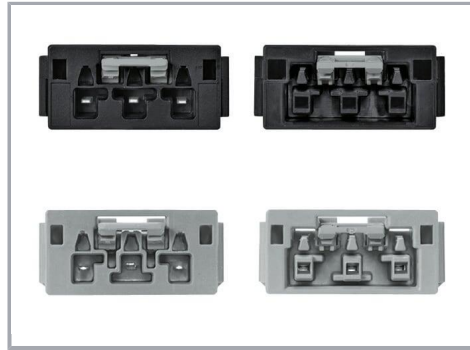
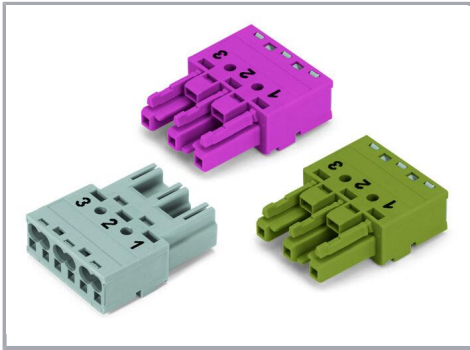

B-coded connectors with different colors can be plugged together.

Important note:

Different colors and/or pole markings are used for circuit identification.

Only connectors of the same color and same pole marking must be plugged together.

B-coded connectors (shown in gray) not only differ in color, but also in their design, making them incompatible with other coded connectors.



Easy circuit identification via different marking and colors

Product family

WINSTA® MIDI

[Show all products from the family](#)

Subject to changes. Please also observe the further product documentation!