

TL2233 SERIES PUSHBUTTON SWITCH

ANTI-VANDAL SWITCHES
 DETECTOR SWITCHES
 DIP SWITCHES
 KEYLOCK SWITCHES
 NAVIGATION SWITCHES
PUSHBUTTON SWITCHES
 ROCKER SWITCHES
 ROTARY SWITCHES
 SLIDE SWITCHES
 SNAP ACTION SWITCHES
 TACTILE SWITCHES
 TOGGLE SWITCHES
 CAP OPTIONS

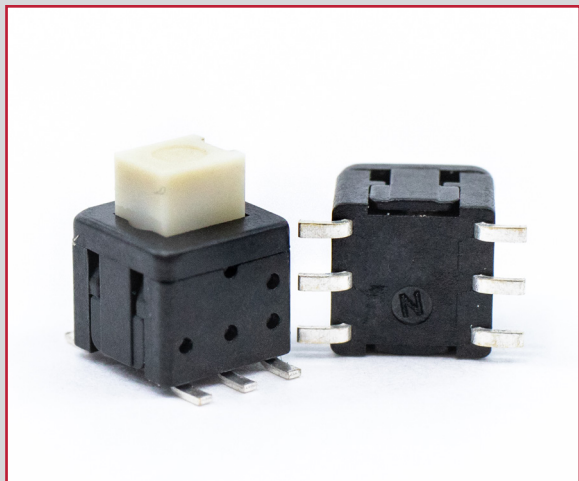

APPLICATIONS / MARKETS

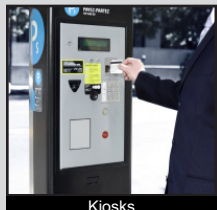
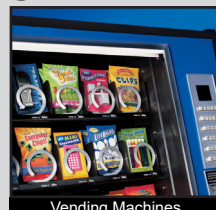

RoHS

SPECIFICATIONS

Electrical Rating: 100mA @ 30VDC
Contact Arrangement: DPDT
Electrical Life: 10,000 Cycles
Contact Resistance: 100mΩ Max. initial
Insulation Resistance: 100MΩ Min. @ 100VDC
Dielectric Strength: 250VAC for 1 Minute
Travel: 1.90mm
Actuation Force: 250 gf ± 80 gf
Operating Temperature: -10°C to 60°C

FEATURES & BENEFITS

- Surface mount design
- Long electrical life
- Momentary function
- Wave solderable

PART NUMBER CONFIGURATOR

Series

TL2233

Function

OA - Momentary

Specifications subject to change without notice 8.18.2021



E-SWITCH®

www.e-switch.com

800.867.2717

1

TL2233 SERIES PUSHBUTTON SWITCH

BODY DIMENSIONS

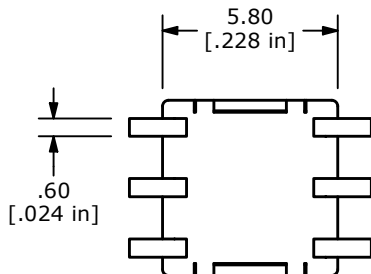
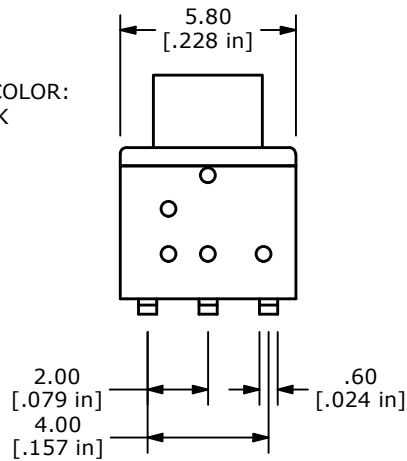
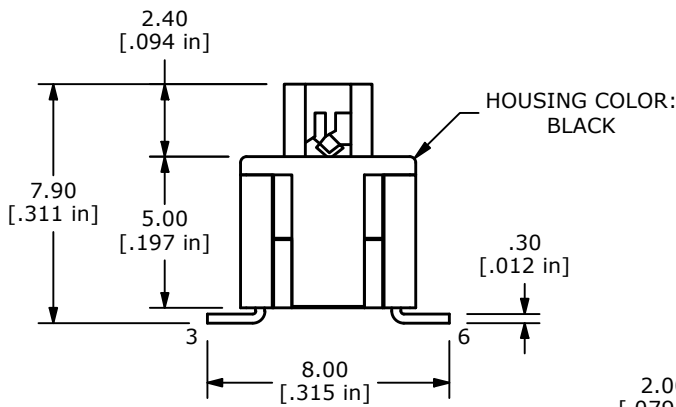
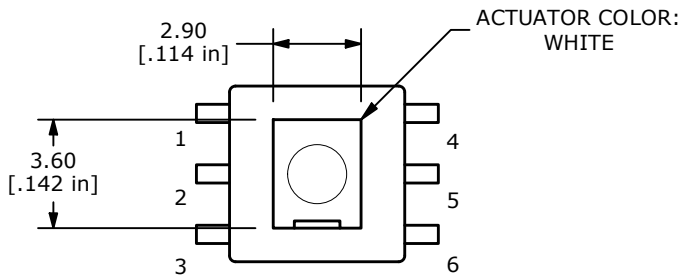
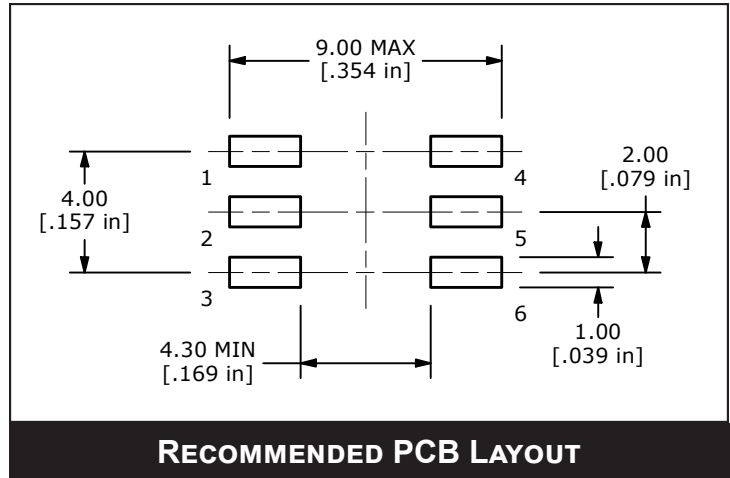
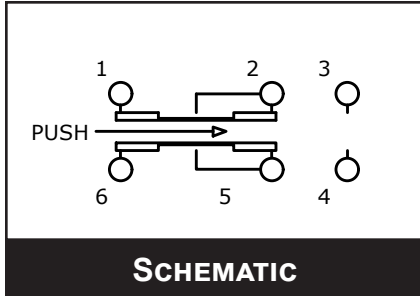

TL2233 SERIES PUSHBUTTON SWITCH

BODY DIMENSIONS TAPE AND REEL

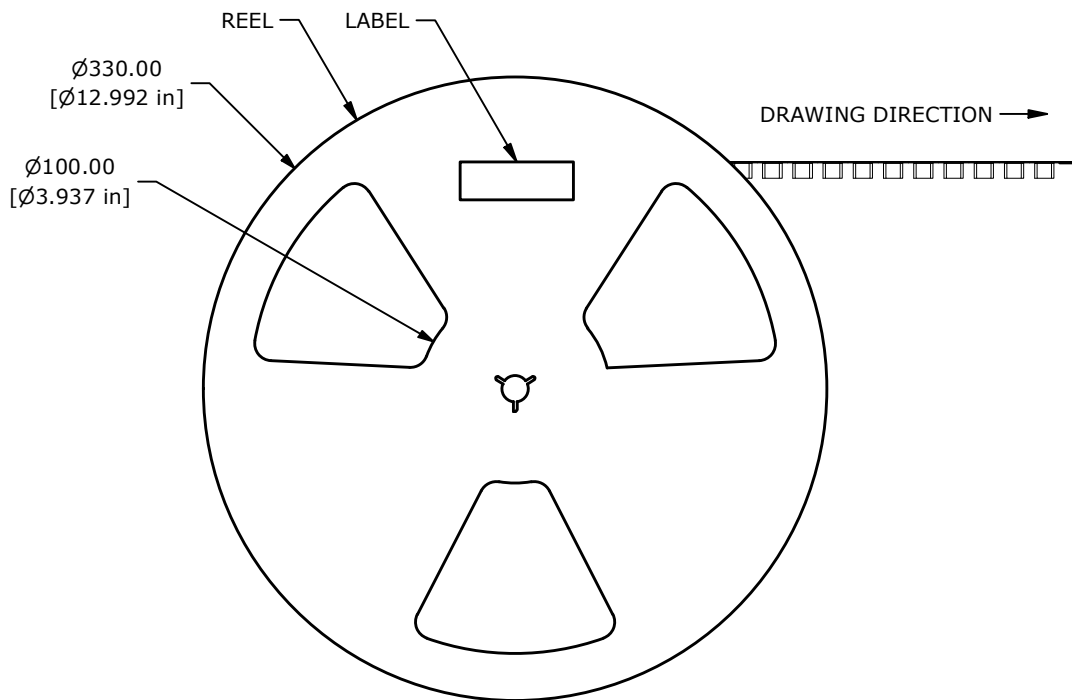
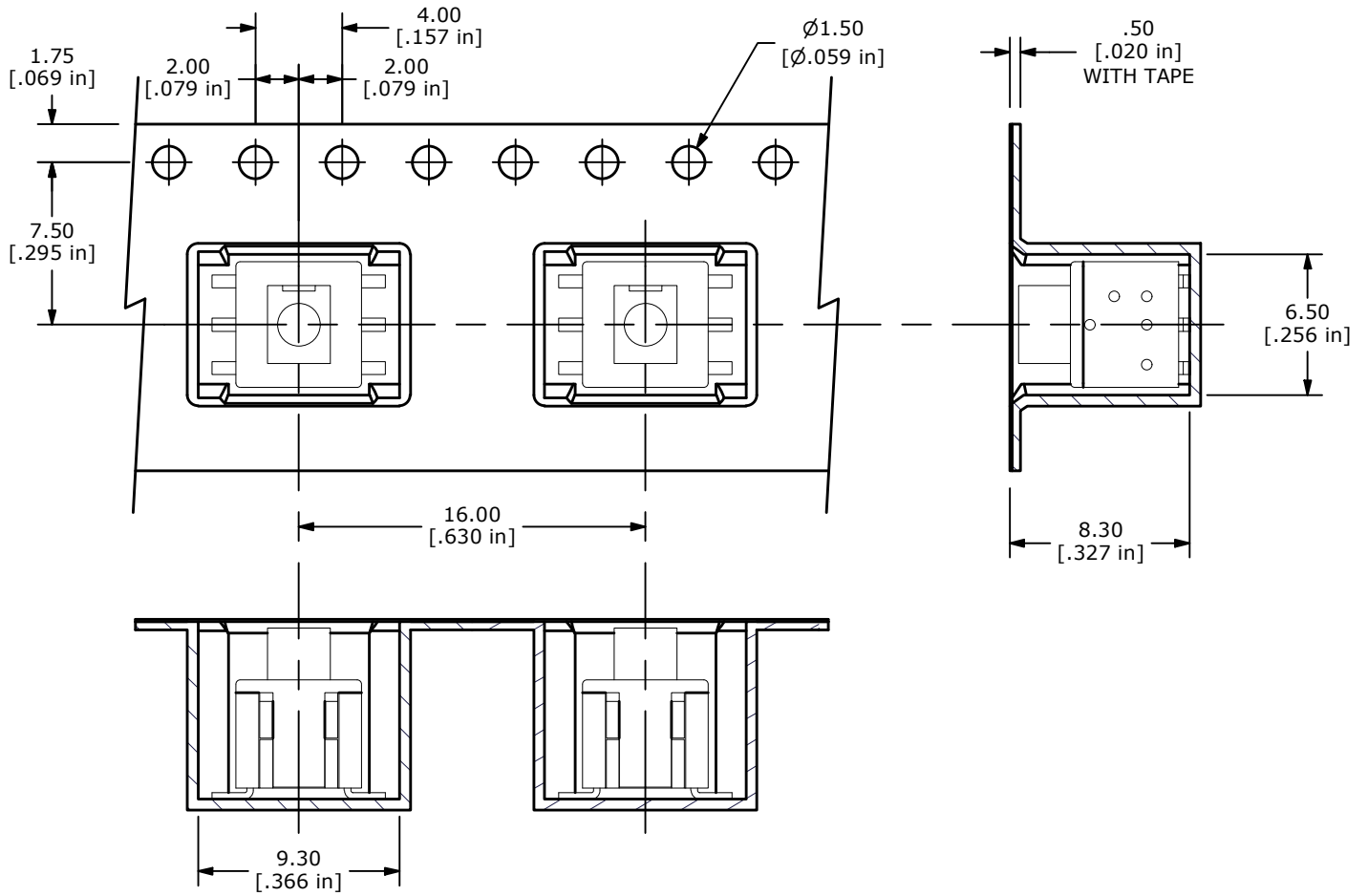

TL2233 SERIES PUSHBUTTON SWITCH

RECOMMENDED SOLDER PROCESS

Most contamination problems can be prevented by exercising care during the cleaning and soldering process. Care should be taken not to immerse or spray unsealed switches during flux removal. Contact E-Switch for specific soldering recommendations and specifications not shown. Generalized soldering procedures are outlined below.

“TYPICAL” SMT REFLOW (Pb and Pb-Free)

Profile Feature	Sn-Pb Eutectic Assembly	Pb-Free Assembly
Average Ramp-Up Rate ($T_{s_{max}}$ to T_p)	3 °C/second max.	3 °C/second max.
Preheat		
-Temperature Min ($T_{s_{min}}$)	100 °C	150 °C
-Temperature Max ($T_{s_{max}}$)	150 °C	200 °C
-Time ($t_{s_{min}}$ to $t_{s_{max}}$)	60-120 seconds	60-180 seconds
Time Maintained above:		
-Temperature (T_L)	183 °C	217 °C
-Time (t_L)	60-150 seconds	60-150 seconds
Time within 5 °C of actual Peak Temperature (t_p)	10-30 seconds	20-40 seconds
Ramp-Down Rate	6 °C/second max.	6 °C/second max.
Time 25 °C to Peak Temperature	6 minutes max.	8 minutes max.

Note 1: All temperatures refer to topside of the package, measured on the package surface.

