

Basic Characteristics Data

Model	Circuit method	Switching frequency [kHz]	Input current [A]	Rated input fuse	PCB/Pattern			Series/Parallel operation availability	
					Material	Single sided	Double sided	Series operation	Parallel operation
DHS50A DHS50B	Forward converter	470	*1	-	Aluminum	Yes		Yes	*2
DHS100A DHS100B	Forward converter	470	*1	-	Aluminum	Yes		Yes	*2
DHS200A DHS250B	Forward converter	360	*1	-	Aluminum	Yes		Yes	*2

*1 Refer to Specification.

*2 Refer to Instruction Manual.

1	Pin Connection	DHS-16
2	Connection for Standard Use	DHS-16
3	Wiring Input/Output Pin	DHS-16
3.1	Wiring input pin	DHS-16
3.2	Wiring output pin	DHS-17
4	Function	DHS-18
4.1	Overcurrent protection	DHS-18
4.2	Overvoltage protection	DHS-18
4.3	Thermal protection	DHS-18
4.4	Remote ON/OFF	DHS-18
4.5	Remote sensing	DHS-18
4.6	Adjustable voltage range	DHS-19
4.7	Withstanding Voltage / Isolation Voltage	DHS-20
5	Series and Parallel Operation	DHS-20
5.1	Series operation	DHS-20
5.2	Redundancy operation	DHS-20
6	Implementation · Mounting Method	DHS-20
6.1	Mounting method	DHS-20
6.2	Stress onto the pins	DHS-21
6.3	Cleaning	DHS-21
6.4	Soldering temperature	DHS-21
6.5	Derating	DHS-21
6.6	Heat sink(Optional parts)	DHS-22
7	Lifetime expectancy depends on stress by temperature difference	DHS-23

1 Pin Connection

●DHS50/100

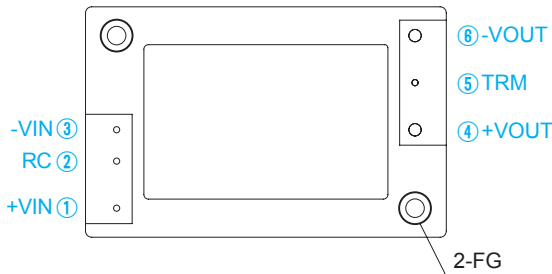

●DHS200/250

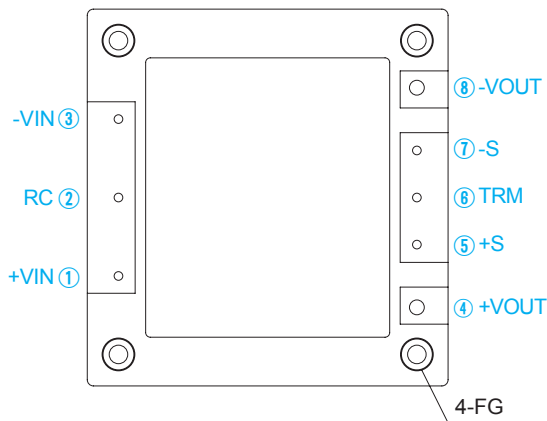

Fig.1.1 Pin Connection (bottom view)

Table 1.1 Pin Connection and function

No.	Pin Connection	Function
DHS50/100	DHS200/250	
①	① +VIN	+DC input
②	② RC	Remote ON/OFF
③	③ -VIN	-DC input
④	④ +VOUT	+DC output
—	⑤ +S	+Remote sensing
⑤	⑥ TRM	Adjustment of output voltage
—	⑦ -S	-Remote sensing
⑥	⑧ -VOUT	-DC output
—	— Mounting hole	Mounting hole

No.	Pin Connection	Reference
DHS50/100	DHS200/250	
①	① +VIN	3.1 Wiring input pin
②	② RC	4.4 Remote ON/OFF
③	③ -VIN	3.1 Wiring input pin
④	④ +VOUT	3.2 Wiring output pin
—	⑤ +S	4.5 Remote sensing
⑤	⑥ TRM	4.6 Adjustable voltage range
—	⑦ -S	4.5 Remote sensing
⑥	⑧ -VOUT	3.2 Wiring output pin
—	— Mounting hole	6.1 "Mounting hole"

2 Connection for Standard Use

■ In order to use the power supply, it is necessary to wire as shown in Fig.2.1 and external components in table2.1.

■ Short the following pins to turn on the power module.

-VIN↔RC, +VOUT↔+S, and -VOUT↔-S (DHS200/250)

[Reference: 4.4 "Remote ON/OFF"
4.5 "Remote sensing"]

■ The DHS Series handles only the DC input.

Avoid applying AC input directly.

It will damage the power supply.

■ Operate with the conduction cooling(e.g. heat radiation from the aluminum base plate to the attached heat sink).

[Reference: 6.5 "Derating"]

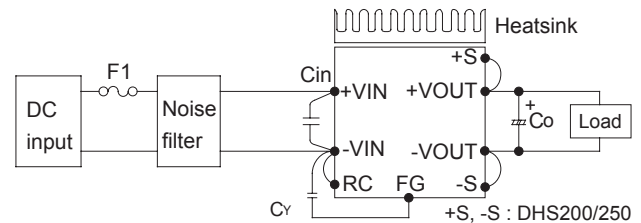

Fig.2.1 Connection for Standard Use

Table 2.1 External components

No.	Symbol	component	Reference
1	F1	Input fuse	3.1 (1) "External fuse"
2	Cy	Primary decoupling capacitor	3.1 (2) "Noise filter/Decoupling capacitor"
3	-	Noise filter	
4	Cin	External capacitor on the input side	3.1 (3) "External capacitor on the input side"
5	Co	External capacitor on the output side	3.2 "Wiring output pin"
6	-	Heatsink	6.5 "Derating"

3 Wiring Input/Output Pin

3.1 Wiring input pin

(1) External fuse

■ Fuse is not built-in on input side. In order to protect the unit, install the normal blow type fuse on input side.

■ When the input voltage from a front end unit is supplied to multiple units, install the normal blow type fuse in each unit.

Table 3.1 Recommended fuses (Normal-blow type)

Model	DHS50A/DHS100A	DHS200A
Rated current	3.15A	5A
Model	DHS50B/DHS100B	DHS250B
Rated current	1.6A	3.15A

(2) Noise filter/Decoupling capacitor

- Install an external noise filter and a decoupling capacitor C_V for low line-noise and for stable operation of the power supply.
- Install a correspondence filter, if a noise standard meeting is required or if the surge voltage may be applied to the unit.
- Install a primary decoupling capacitor C_V , with more than 470pF, near the input pins(within 50mm from the pins).
- When the total capacitance of the primary decoupling capacitor is more than 8800pF, the nominal value in the specification may not be met by the Hi-Pot test between input and output. In this case, it is that a capacitor should be installed between output and FG.

(3) External capacitor on the Input side.

- Install an external capacitor C_{in} between +VIN and -VIN input pins for low line-noise and for stable operation of the power supply.

DHS50A/100A	: more than 22 μ F *
DHS200A	: more than 47 μ F *
DHS50B/100B/250B	: more than 0.1 μ F

*When the line inductance is high or ambient temperature is lower than -20°C, please increase C_{in} value more than the value indicated above.

- When the line impedance is high or the input voltage rise quickly at start-up(less than 10 μ s), install a capacitor C_{in} between +VIN and -VIN input pins(within 50mm from pins).

DHS50B/100B	: more than 10 μ F
DHS250B	: more than 22 μ F

(4) Input voltage range/Input current range

- The specification of input ripple voltage is shown as below.

Ripple voltage	DHS50A/100A/200A	: less than 10Vp-p
	DHS50B/100B/250B	: less than 20Vp-p

- Make sure that the voltage fluctuation, including the ripple voltage, will not exceed the input voltage range.

- Use a front end unit with enough power, considering the start-up current I_p of this unit.

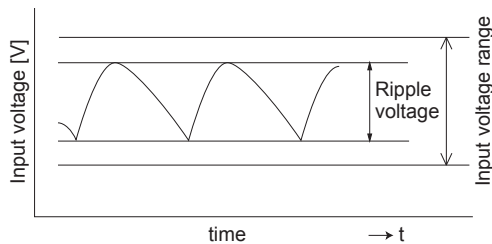

Fig.3.1 Input voltage ripple

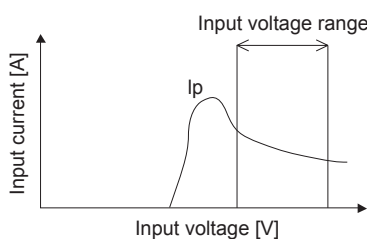

Fig.3.2 Input current characteristics

(5) Operation with AC input

- The DHS series handles only for the DC input.

A front end unit(AC/DC unit) is required when the DHS series is operated with AC input.

(6) Reverse input voltage protection

- Avoid the reverse polarity input voltage. It will break the power supply.

It is possible to protect the unit from the reverse input voltage by installing an external diode.

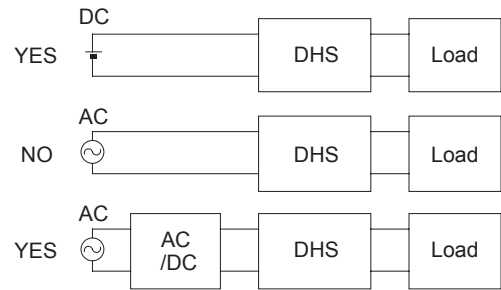

Fig.3.3 Use with AC input

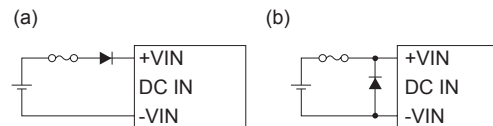

Fig.3.4 Reverse input voltage protection

3.2 Wiring output pin

- Install an external capacitor C_o between +VOUT and -VOUT pins for stable operation of the power supply.

Recommended capacitance of C_o is shown in Table 3.2.

- Select the high frequency type capacitor. Output ripple and start-up waveform may be influenced by ESR ESL of the capacitor and the wiring impedance.

- Install a capacitor C_o near the output pins(within 50mm from the pins).

Table 3.2 Recommended capacitance C_o [μ F]

Model	Temperature of Base plate			
	Tbp=0~+100 °C		Tbp=-40~+100 °C	
	DHS50/100	DHS200/250	DHS50/100	DHS200/250
Output voltage (V)				
3.3	2200	2200	2200 X 3	2200 X 3
5	2200	2200	2200 X 3	2200 X 3
7.5	-	2200	-	2200 X 3
12	470	1000	470 X 3	1000 X 3
15	470	1000	470 X 3	1000 X 3
24	220	470	220 X 3	470 X 3
28	220	470	220 X 3	470 X 3
48	-	330	-	330 X 3

- The specified ripple and ripple noise are measured by the method introduced in Fig. 3.5.

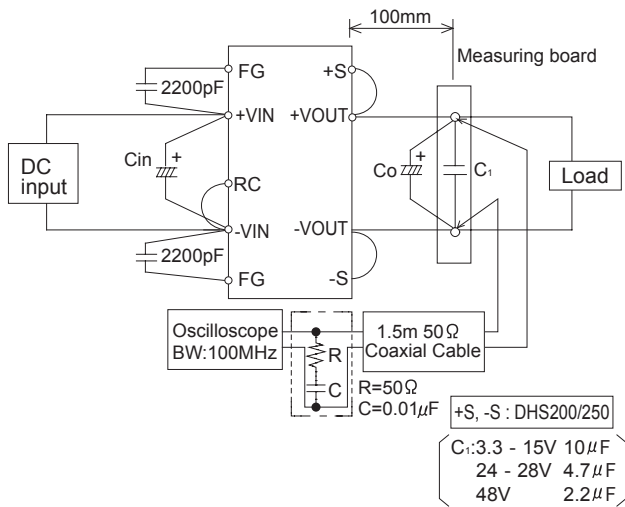

Fig. 3.5 Method of Measuring Output Ripple and Ripple Noise

4 Function

4.1 Overcurrent protection

Over Current Protection (OCP) is built in and works over 105% of the rated current or higher. However, use in an over current situation must be avoided whenever possible. The output voltage of the power module will recover automatically if the fault causing over current is corrected.

When the output voltage drops after OCP works, the power module enters a "hiccup mode" where it repeatedly turns on and off at a certain frequency.

4.2 Overvoltage protection

Over Voltage Protection (OVP) is built in. When OVP works, output voltage can be recovered by shutting down DC input for at least one second or by turning off the remote control switch for one second without shutting down the DC input. The recovery time varies according to input voltage and input capacitance.

Remarks:

Note that devices inside the power module may fail when a voltage greater than the rated output voltage is applied from an external power supply to the output terminal of the power module. This could happen in in-coming inspections that include OVP function test or when voltage is applied from the load circuit. OVP can be tested by using the TRM terminal. Consult us for details.

4.3 Thermal protection

Over Temperature Protection (OTP) is built in. If the base plate temperature exceeds 100°C, OTP will work, causing the output voltage to drop. Output voltage can be recovered by shutting down DC input for at least one second or by turning RC off for one second without shutting down the DC input.

4.4 Remote ON/OFF

The remote ON/OFF function is incorporated in the input circuit and operated with RC and -VIN.

Table 4.1 Remote ON/OFF Specifications

ON/OFF logic	Between RC and -VIN	Output voltage
Negative	L level(0 - 1.2V) or short	ON
	H level(3.5 - 7.0V) or open	OFF

When RC is at low level, a current of 0.5mA typ will flow out. When Vcc is used, keep it within the following rage:
 $3.5 \leq VCC \leq 7V$.

When remote ON/OFF is not used, short RC and -VIN.

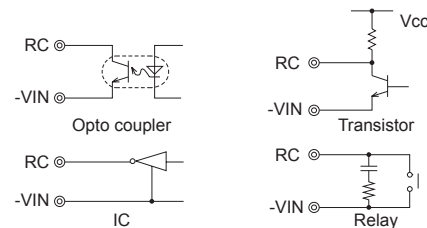

Fig. 4.1 RC Connection Example

●DHS200, DHS250

4.5 Remote sensing

(1) When Remote Sensing is Not Used

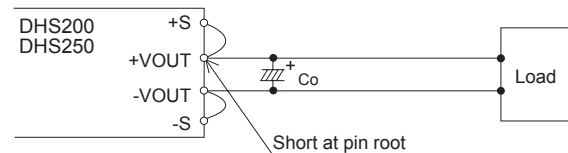

Fig. 4.2 When Remote Sensing is Not Used (DHS200/250)

When remote sensing is not used, make sure +VOUT and +S are shorted, and that -VOUT and -S are shorted as well.

Keep the patterns between +S and +VOUT and between -S and -VOUT as short as possible. Avoid a looping pattern. If noise enters the loop, the operation of the power module will become unstable.

(2) When Remote Sensing is Used

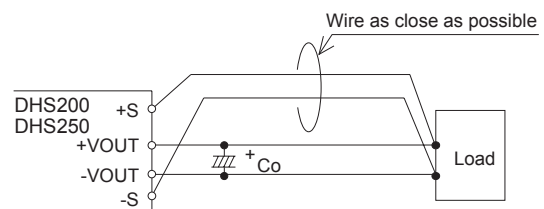

Fig. 4.3 When Remote Sensing is Used (DHS200/250)

Using remote sensing with long wires may cause output voltage to become unstable. Consult us if long sensing wiring is necessary.

Sensing patterns or wires should be as short as possible. If wires are used, use either twisted-pair or shielded wires.

■ Use wide PCB patterns or thick wires between the power module and the load. Line drop should be kept less than 0.3V. Make sure output voltage from the power module stays within the specified range.

■ If the sensing patterns are shorted by mistake, a large current may flow and damage the pattern. This can be prevented by installing fuses or resistors close to the load.

As wiring or load impedance may generate oscillation or large fluctuations in output voltage, make sure enough evaluation is given in advance.

4.6 Adjustable voltage range

■ Output voltage between +VOUT and -VOUT can be adjusted by connecting external resistors to TRM.

■ When the output voltage adjustment is not used, open the TRM pin respectively.

■ When the output voltage adjustment is used, note that the over-voltage protection circuit operates when the output voltage sets too high.

■ The wiring to the potentiometer should be as short as possible.

As the ambient temperature fluctuation characteristics deteriorates depending on the types of resistors and potentiometers used, please use resistors and potentiometers of the following specifications:

Resistors..... Metal film type, coefficient less than $\pm 100\text{ppm}/^\circ\text{C}$

Potentiometers ... Cermet type, coefficient less than $\pm 300\text{ppm}/^\circ\text{C}$

■ When the input voltage is 60 - 66VDC or 200 - 250VDC, the output voltage adjustment range becomes as shown in fig . 4.4.

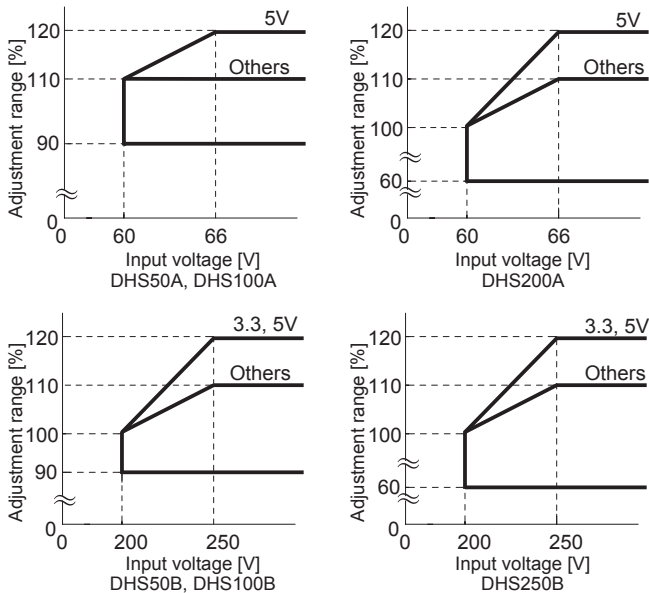

Fig. 4.4 Output Voltage Adjustment Range

● DHS50, DHS100

■ To increase the output voltage, turn the potentiometer clockwise and connect in such a way that the resistance value between ② and ③ becomes small.

To decrease the output voltage, turn the potentiometer counter-clockwise.

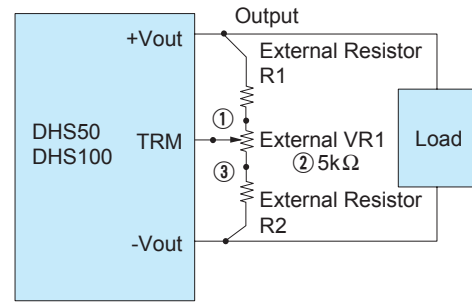

Fig. 4.5 Connecting External Devices (DHS50, DHS100)

Table 4.2 Recommended Values of External Resistors (DHS50, DHS100)

No.	Output Voltage	Adjustable Range			
		VOUT $\pm 5\%$		VOUT $\pm 10\%$	
		R1	R2	R1	R2
1	3.3V	5.1k Ω	3.3k Ω	3.3k Ω	2.2k Ω
2	5V	12k Ω		8.2k Ω	
3	12V	15k Ω		10k Ω	
4	15V	22k Ω		15k Ω	
5	24V	39k Ω		27k Ω	
6	28V	47k Ω		33k Ω	

● DHS200, DHS250

(1) Output voltage adjusting

■ Output voltage can be adjusted by connecting an external potentiometer (VR1) and resistors (R1 and R2) as shown in Fig. 4.6.

Output voltage will increase if the resistance between ① and ② is reduced by turning the potentiometer clockwise.

Recommended values for external components are shown in Table 4.3.

Consult us if the power module is used in a different configuration.

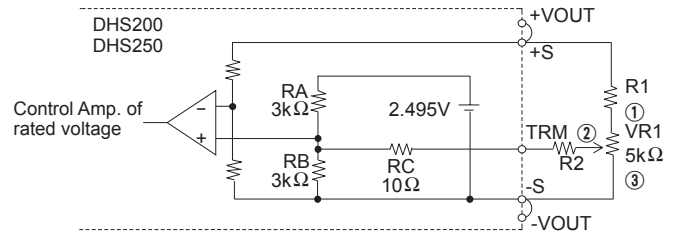

Fig. 4.6 Connecting External Parts (DHS250)

Table 4.3 Recommended Values of External Resistors (DHS250)

No.	Output Voltage	Adjustable Range			
		VOUT $\pm 5\%$		VOUT $\pm 10\%$	
		R1	R2	R1	R2
1	3.3V	2.4k Ω	12k Ω	2.4k Ω	8.2k Ω
2	5V	5.6k Ω		5.6k Ω	
3	7.5V	10k Ω		10k Ω	
4	12V	18k Ω		18k Ω	
5	15V	24k Ω		24k Ω	
6	24V	43k Ω		43k Ω	
7	28V	47k Ω		47k Ω	
8	48V	91k Ω		91k Ω	

(2) Output voltage decreasing

■By connecting the external resistor (RD), output voltage becomes adjustable to decrease.

The external resistor (RD) is calculated the following equation.

$$RD = \frac{1.51 \times \frac{V_{OD}}{V_{OR}} - 0.01}{1.0 - \frac{V_{OD}}{V_{OR}}} \text{ [k}\Omega\text{]}$$

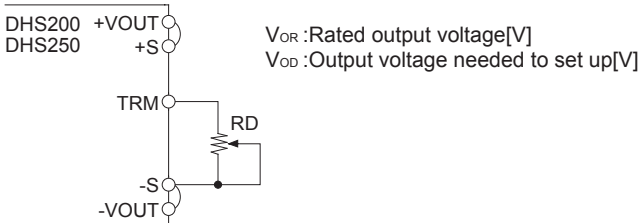

Fig. 4.7 Connection for output voltage decreasing (DHS200/250)

(3) Output voltage increasing

■By connecting the external resistor (RU), output voltage becomes adjustable to increase.

The external resistor (RU) is calculated the following equation.

$$RU = \frac{\left[3.0 \times \frac{V_{OR}}{V_{ref}} - 1.51 \right] \times \frac{V_{OU}}{V_{OR}} + 0.01}{\frac{V_{OU}}{V_{OR}} - 1.0}$$

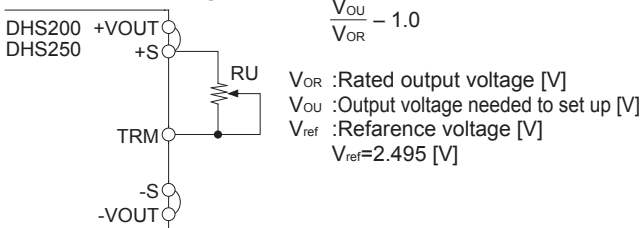

Fig. 4.8 Connection for output voltage increasing (DHS200/250)

4.7 Withstanding Voltage / Isolation Voltage

■When testing the withstanding voltage, make sure the voltage is increased gradually. When turning off, reduce the voltage gradually by using the dial of the hi-pot tester. Do not use a voltage tester with a timer as it may generate voltage several times as large as the applied voltage.

5 Series and Parallel Operation

5.1 Series operation

■Series operation is available by connecting the outputs of two or more power supplies, as shown below. Output current in series connection should be lower than the lowest rated current in each unit.

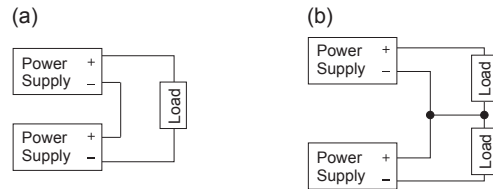

Fig. 5.1 Examples of series operation

5.2 Redundancy operation

■Parallel operation is not possible.

■Redundancy operation is available by wiring as shown below.

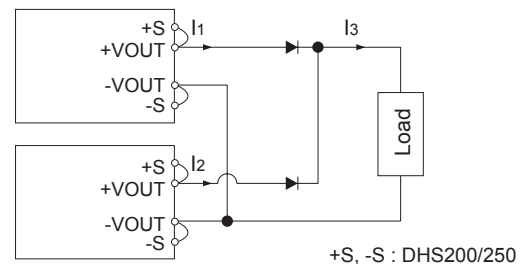

Fig. 5.2 Example of Redundancy Operation

■Even a slight difference in output voltage can affect the balance between the values of I_1 and I_2 .

Please make sure that the value of I_3 does not exceed the rated current of a power supply.

$$I_3 \leq \text{the rated current value}$$

6 Implementation · Mounting Method

6.1 Mounting method

■The unit can be mounted in any direction. When two or more power supplies are used side by side, position them with proper intervals to allow enough air ventilation. Aluminum base plate temperature around each power supply should not exceed the temperature range shown in derating curve.

■Avoid placing the DC input line pattern lay out underneath the unit, it will increase the line conducted noise. Make sure to leave an ample distance between the line pattern lay out and the unit. Also avoid placing the DC output line pattern underneath the unit because it may increase the output noise. Lay out the pattern away from the unit.

■High-frequency noise radiates directly from the unit to the atmosphere. Therefore, design the shield pattern on the printed circuit board and connect its one to FG.

The shield pattern prevents noise radiation.

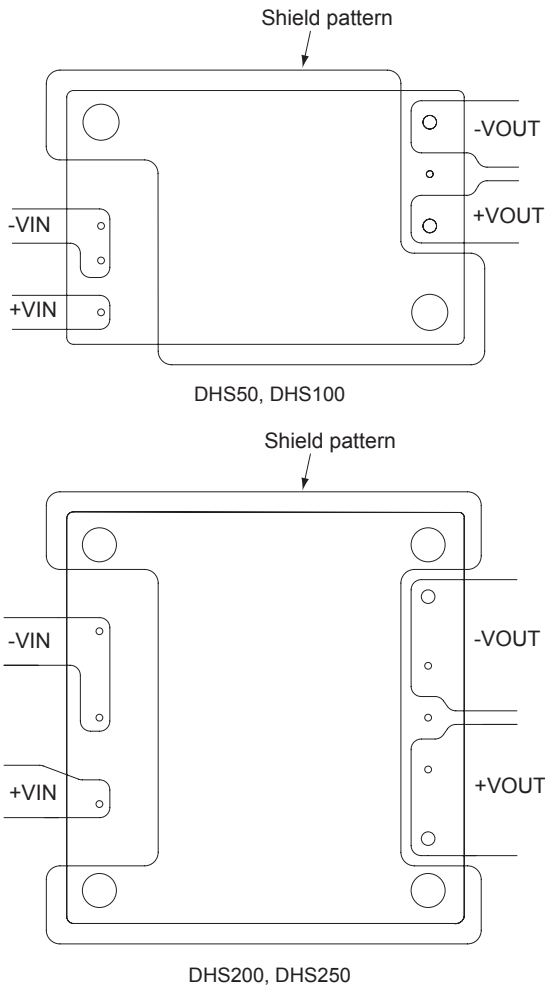

Fig. 6.1 Shield pattern lay out (bottom view)

6.2 Stress onto the pins

- Applying excessive stress to the input or output pins of the power module may damage internal connections. Avoid applying stress in excess of that shown in Fig. 6.1.
- Input and output pins are soldered onto the internal PCB. Do not bend or pull the leads with excessive force.
- As unexpected stress may be applied to the pins, set the diameter of the PCB mounting hole at 3.5mm.
- As unexpected stress may be applied to the pins from vibration or shock, fix the power module by using the mounting holes with screws to reduce stress.
- Fix the power module to the PCB with the screws before soldering the input and output pins to prevent the PCB pattern being damaged.

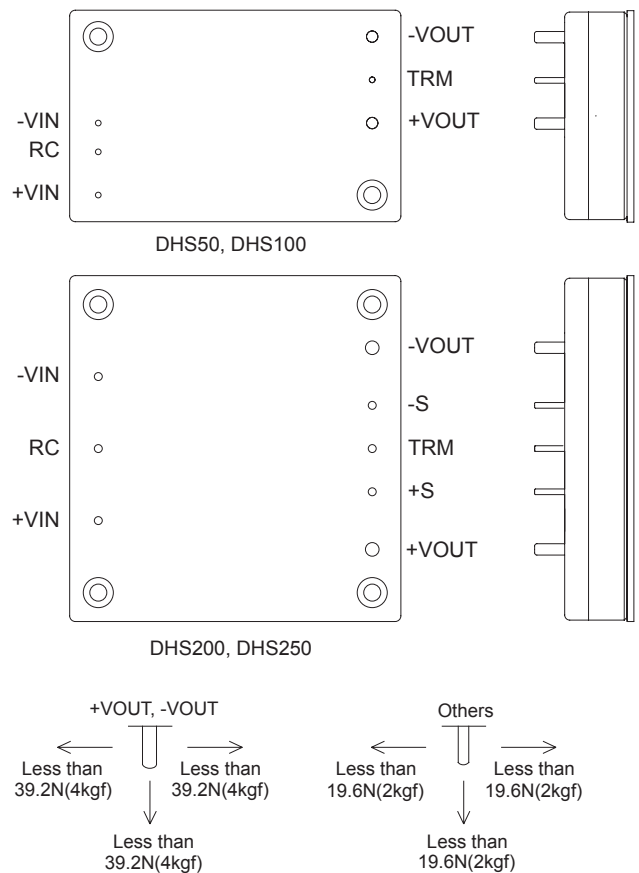

Fig. 6.2 Stress onto Pins

6.3 Cleaning

- Clean the soldered side of the power module with a brush. Prevent liquid from getting into the power module. Do not clean by soaking the power module into liquid.
- Do not allow solvent to come in contact with product labels or resin cases as this may change the color of the resin case or cause deletion of the letters printed on the product label.
- After cleaning, dry the power modules well.

6.4 Soldering temperature

- Flow soldering: 260°C for up to 15 seconds.
- Soldering iron (26W): 450°C for up to 5 seconds.

6.5 Derating

- Use the power modules with conduction cooling (e.g. heat dissipation from the aluminum base plate to the attached heat sink). Fig. 6.3 shows the derating curves with respect to the aluminum base plate temperature. Note that operation within the hatched areas will cause a significant level of ripple and ripple noise.
- Please measure the temperature on the aluminum base plate edge side when you cannot measure the temperature of the center part of the aluminum base plate. In this case, please take 5deg temperature margin from the derating characteristic of Figure 6.3.

■ It is necessary to note the thermal fatigue life by power cycle. Please reduce the temperature fluctuation range as much as possible when the up and down of the temperature are frequently generated.

Contact us for more information on cooling methods.

● DHS50, DHS100

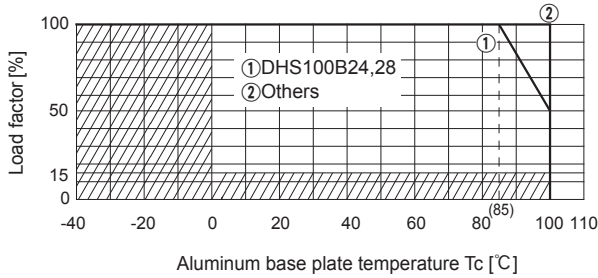

● DHS200

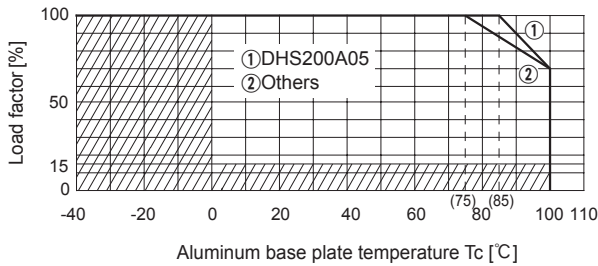

● DHS250

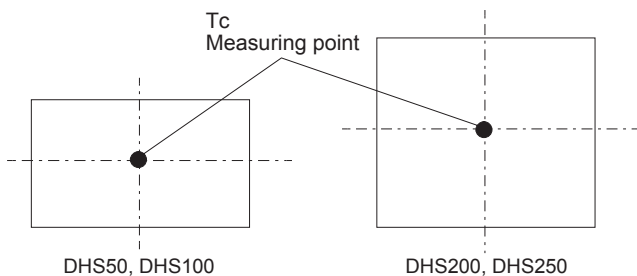
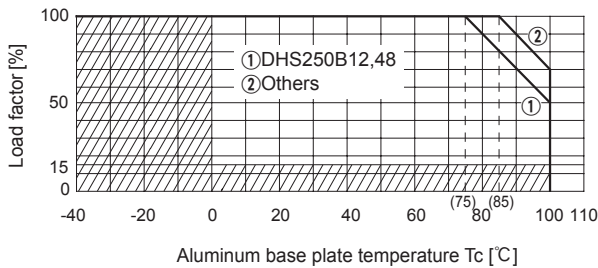

Fig.6.3 Derating Curve

6.6 Heat sink(Optional parts)

● DHS50, DHS100

■ The power module works with conduction cooling and needs heat dissipation using heat sinks. Optional heat sinks are available for DHS Series. Refer to Table 6.1 and Table 6.2 for details on the thermal resistance of heat sinks.

Table 6.1 Types of Heat Sinks Available

No.	Model	Size[mm]			Thermal resistance[°C/W]		Style
		H	W	D	Convection (0.1m/s)	Forced Air	
1	F-QB-F1	12.7	58.4	37.6	14.0	Refer Fig.6.5	Horizontal
2	F-QB-F2	12.7	58.7	37.3			Vertical
3	F-QB-F3	25.4	58.4	37.6	7.5		Horizontal
4	F-QB-F4	25.4	58.7	37.3			Vertical
5	F-QB-F5	38.1	58.4	37.6	5.0		Horizontal
6	F-QB-F6	38.1	58.7	37.3			Vertical

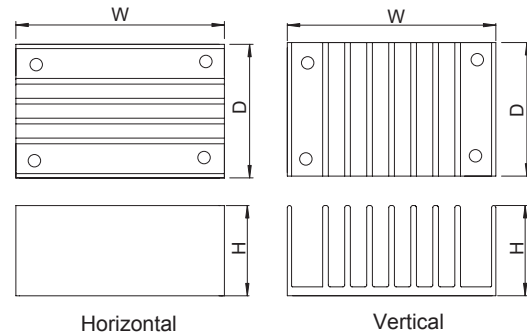

Fig.6.4 Heat Sink Types

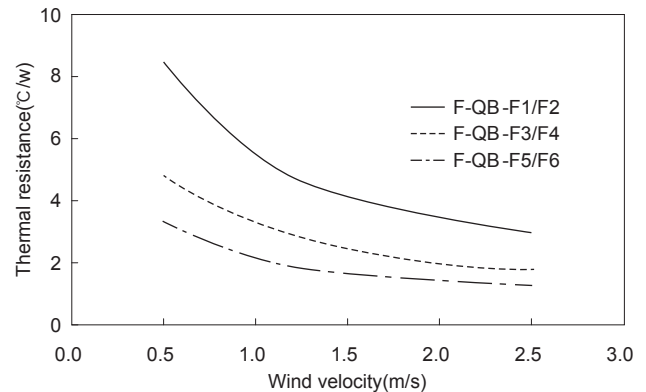

Fig.6.5 Thermal Resistance of Heat Sink(Forced Air)

●DHS200, DHS250

Table 6.2 Types of Heat Sinks Available

No.	Model	Size[mm]			Thermal resistance[°C/W]		Style
		H	W	D	Convection (0.1m/s)	Forced Air	
1	F-CBS-F1	12.7	57.9	61.5	7.5	Refer Fig.6.7	Horizontal
2	F-CBS-F2	12.7	58.4	61.0			Vertical
3	F-CBS-F3	25.4	57.9	61.5	4.6		Horizontal
4	F-CBS-F4	25.4	58.4	61.0			Vertical
5	F-CBS-F5	38.1	57.9	61.5	3.0		Horizontal
6	F-CBS-F6	38.1	58.4	61.0			Vertical

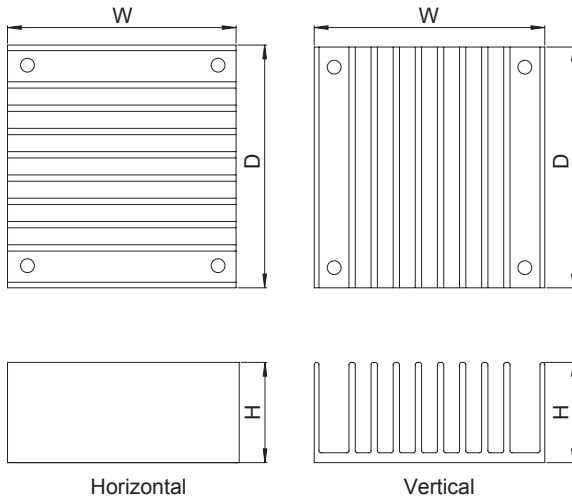

Fig. 6.6 Heat Sink Types

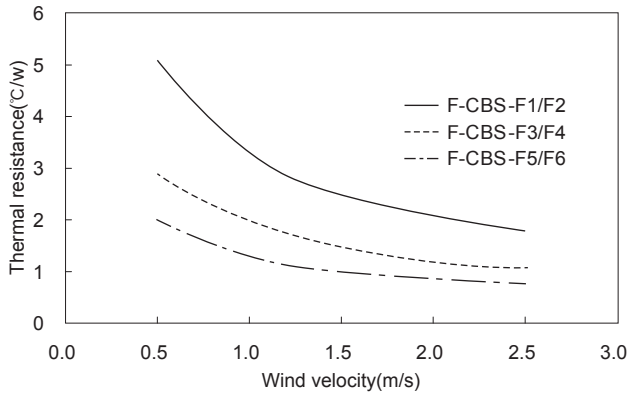

Fig.6.7 Thermal Resistance of Heat Sink(Forced Air)

7 Lifetime expectancy depends on stress by temperature difference

■Regarding lifetime expectancy design of solder joint, following contents must be considered.

It must be careful that the soldering joint is stressed by temperature rise and down which is occurred by self-heating and ambient temperature change.

The stress is accelerated by thermal-cycling, therefore the temperature difference should be minimized as much as possible if temperature rise and down is occurred frequently.

■Product lifetime expectancy depends on the aluminum base plate central temperature difference (ΔT_c) and number of cycling in a day is shown in Fig.7.1.

If the aluminum base plate center part temperature changes frequently by changing output load factor etc., the above the lifetime expectancy design should be applied as well.

Please contact us for details.

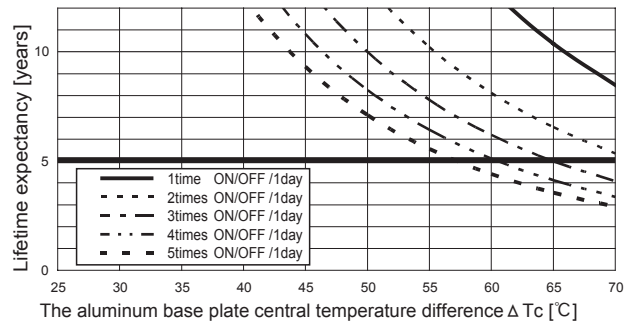

Fig7.1 Lifetime expectancy against rise/fall temperature difference