

.050" [1.27mm] CONTACT CENTERS, RIGHT ANGLE BEND

FEATURES

- * Accommodates .062 ±.008" PC board
(Consult factory for other board thicknesses)
- * PPS or PCT insulator
- * Molded-in key available
- * High reliability/high cycle hairpin bellows contact
- * 1 amp current rating
- * 150 grams normal force minimum

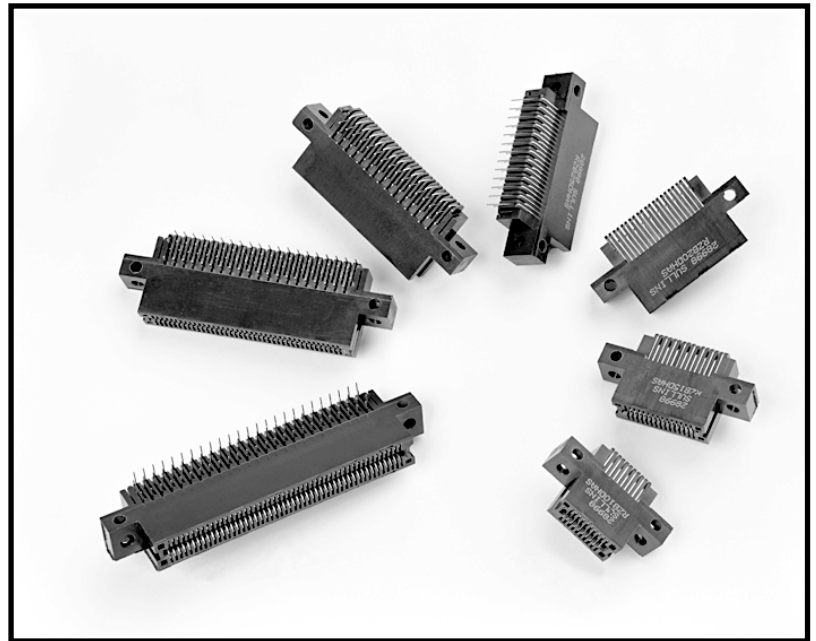

READOUT

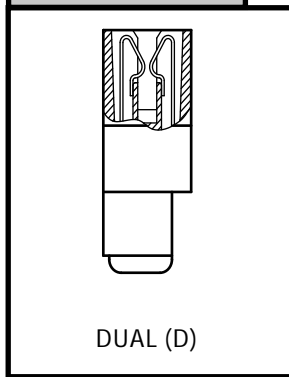

TERMINATION TYPE

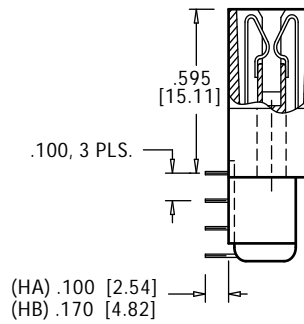

MOUNTING STYLE

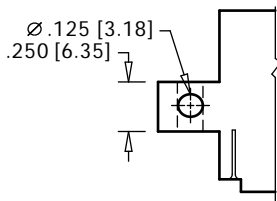

SIDE MOUNTING (S)



NO MOUNTING EARS (N)

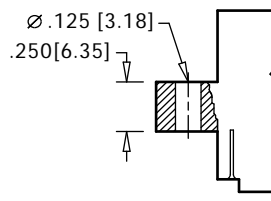

FLUSH MOUNTING (D)

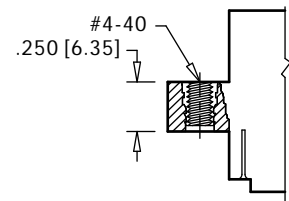

THREADED INSERT (T)

.050" [1.27mm] CONTACT CENTERS, RIGHT ANGLE BEND

PART NUMBER CODING

R Z B 10 D HA S -SXXX

MATERIALS (Insulator/Contact)
 R = PPS/Phosphor Bronze
 A = PPS/Beryllium Copper
 L = PCT/Phosphor Bronze
 M = PCT/Beryllium Copper
 Consult Factory for Other Materials

CONTACT FINISH
 Contact Surface Termination Underplate
 Z = .000010" Gold .000100" Tin .000050" Nickel
 X = .000030" Gold .000100" Tin .000050" Nickel

CONTACT CENTERS
 B = .050" [1.27 mm]

MODIFICATIONS (Consult Factory)
 Omit For Standard

MOUNTING STYLE (Opposite Page)
 S = Side Mounting
 D = Flush Mounting
 N = No Mounting
 T = Flush Mounting With Threaded Insert

TERMINATION TYPE (Opposite Page)
 HA = .100" Staggered Dip Solder
 HB = .170" Staggered Dip Solder

READOUT (Opposite Page)
 D = Dual

NUMBER OF CONTACT POSITIONS
 5 thru 120

DIMENSIONS

Dimensions in [] are in millimeters, all others in inches.

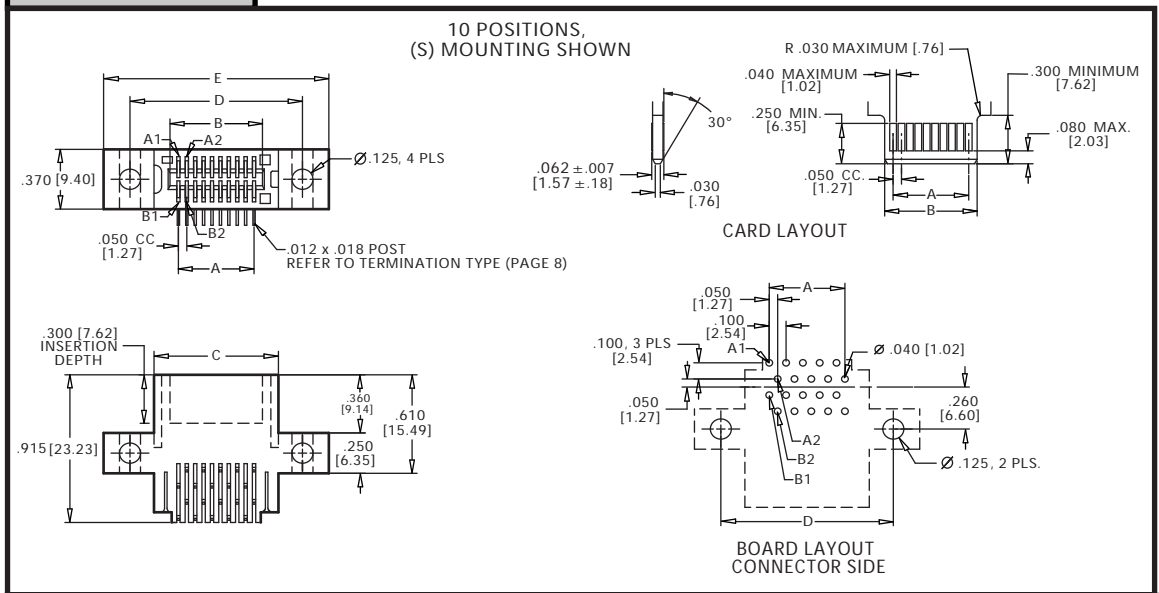

PART NUMBER*	NUMBER OF CONTACTS	INCHES					MILLIMETERS				
		A	B	C	D	E	A	B	C	D	E
		± 0.005	± 0.005	± 0.015	± 0.01	± 0.02	± 0.13	± 0.13	± 0.38	± 0.25	± 0.51
RZB05D __	5/10	0.200	0.300	0.490	0.776	1.090	5.08	7.62	12.45	19.71	27.69
RZB06D __	6/10	0.250	0.350	0.540	0.826	1.140	6.35	8.89	13.72	20.98	28.96
RZB10D __	10/20	0.450	0.550	0.740	1.026	1.340	11.43	13.97	18.80	26.06	34.04
RZB13D __	13/26	0.600	0.700	0.890	1.176	1.490	15.24	17.78	22.61	29.87	37.85
RZB15D __	15/30	0.700	0.800	0.990	1.276	1.590	17.78	20.32	25.15	32.41	40.39
RZB20D __	20/40	0.950	1.050	1.240	1.526	1.840	24.13	26.67	31.50	38.76	46.74
RZB22D __	22/44	1.050	1.150	1.340	1.626	1.940	26.67	29.21	34.04	41.30	49.28
RZB25D __	25/50	1.200	1.300	1.490	1.776	2.090	30.48	33.02	37.85	45.11	53.09
RZB30D __	30/60	1.450	1.550	1.740	2.026	2.340	36.83	39.37	44.20	51.46	59.44
RZB34D __	34/68	1.650	1.750	1.940	2.226	2.540	41.91	44.45	49.28	56.54	64.52
RZB35D __	35/70	1.700	1.800	1.990	2.276	2.590	43.18	45.72	50.55	57.81	65.79
RZB40D __	40/80	1.950	2.050	2.240	2.526	2.840	49.53	52.07	56.90	64.16	72.14
RZB45D __	45/90	2.200	2.300	2.490	2.776	3.090	55.88	58.42	63.25	70.51	78.49
RZB50D __	50/100	2.450	2.550	2.740	3.026	3.340	62.23	64.77	69.60	76.86	84.84
RZB60D __	60/120	2.950	3.050	3.240	3.526	3.840	74.93	77.47	82.30	89.56	97.54
RZB64D __	64/128	3.150	3.250	3.440	3.726	4.040	80.01	82.55	87.38	94.64	102.62
RZB75D __	75/150	3.700	3.800	3.990	4.276	4.590	93.98	96.52	101.35	108.61	116.59
RZB80D __	80/160	3.950	4.050	4.240	4.526	4.840	100.33	102.87	107.70	114.96	122.94
RZB85D __	85/170	4.200	4.300	4.490	4.776	5.090	106.68	109.22	114.05	121.31	129.29
RZB95D __	95/190	4.700	4.800	4.990	5.276	5.590	119.38	121.92	126.75	134.01	141.99
RZB100D __	100/200	4.950	5.050	5.240	5.526	5.840	125.73	128.27	133.10	140.36	148.34
RZB105D __	105/210	5.200	5.300	5.490	5.776	6.090	132.08	134.62	139.45	146.71	154.69
RZB108D __	108/216	5.350	5.450	5.640	5.926	6.240	135.89	138.43	143.26	150.52	158.50
RZB110D __	110/220	5.450	5.550	5.740	6.026	6.340	138.43	140.97	145.80	153.06	161.04
RZB120D N	120/240	5.950	6.050	6.240			151.13	153.67	158.50		

* For complete part number add termination type and mounting style from Part Number Coding (e.g. RZB40DHAD).

