

Sensor/actuator cable - SAC-4P-M12MR-M12FS/.../... - 1697030

Please be informed that the data shown in this PDF Document is generated from our Online Catalog. Please find the complete data in the user's documentation. Our General Terms of Use for Downloads are valid (<http://phoenixcontact.com/download>)



Sensor/actuator cable, 4-position, Variable cable type, Plug angled M12, A-coded, on Socket straight M12, A-coded, cable length: Free input (0.2 ... 40.0 m)

Your advantages

- ✓ Easy and safe: 100% electrically tested plug-in components
- ✓ Flexible solutions - configurable materials with variable cable types and cable lengths

Key Commercial Data

Packing unit	1 pc
Minimum order quantity	25 pc

Technical data

Dimensions

Length of cable	Free input (0.2 ... 40.0 m)
-----------------	-----------------------------

Ambient conditions

Ambient temperature (operation)	-25 °C ... 90 °C (Plug / socket)
Degree of protection	IP65/IP68/IP69K

General

Rated current at 40°C	4 A
Rated voltage	250 V AC
	250 V DC
Number of positions	4
Insulation resistance	≥ 100 MΩ
Coding	A - standard
Standards/regulations	M12 connector IEC 61076-2-101
Status display	No
Protective circuit/component	unwired
Overvoltage category	II
Degree of pollution	3
Insertion/withdrawal cycles	≥ 100
Torque	0.4 Nm (M12 connector)

Material

Sensor/actuator cable - SAC-4P-M12MR-M12FS/.../... - 1697030

Technical data

Material

Flammability rating according to UL 94	HB
Contact material	CuSn
Contact surface material	Ni/Au
Contact carrier material	TPU GF
Material of grip body	TPU, hardly inflammable, self-extinguishing
Material, knurls	Zinc die-cast, nickel-plated
Sealing material	NBR

Line characteristics

Note	This item is a sensor/actuator cable with a freely selectable cable type. The technical data for all possible cable types is listed in the table below.
------	---

Standards and Regulations

Standard designation	M12 connector
Standards/regulations	IEC 61076-2-101
Flammability rating according to UL 94	HB

PUR/PVC gray [100]

Cable type	PUR/PVC gray
Cable type (abbreviation)	100
Cable abbreviation	LiYY-11Y
Conductor cross section	0.34 mm ²
AWG signal line	22
Conductor structure signal line	42x 0.10 mm
Core diameter including insulation	1.5 mm ±0.05 mm
Thickness, insulation	≥ 0.3 mm (Core insulation)
	≥ 0.38 mm (Outer cable sheath)
	approx. 0.35 mm (Inner sheath)
Wire colors	brown, white, blue, black
Overall twist	4 wires, twisted
External sheath, color	gray RAL 7001
External cable diameter D	5.2 mm ±0.2 mm
Smallest bending radius, fixed installation	52 mm
Smallest bending radius, movable installation	52 mm
Number of bending cycles	2000000
Bending radius	52 mm
Traversing path	5 m
Traversing rate	3 m/s
Cable weight	39 kg/km
Outer sheath, material	PUR
Material, inner sheath	PVC
Material conductor insulation	PVC
Conductor material	Bare Cu litz wires

Sensor/actuator cable - SAC-4P-M12MR-M12FS/.../... - 1697030

Technical data

PUR/PVC gray [100]

Insulation resistance	≥ 100 MΩ*km (at 20 °C)
Conductor resistance	max. 58 Ω/km (at 20 °C)
Nominal voltage, cable	≤ 300 V
Test voltage, cable	≥ 3000 V
Flame resistance	in accordance with DIN UL-Style 20549
Ambient temperature (operation)	-25 °C ... 80 °C (cable, fixed installation)
	-5 °C ... 80 °C (cable, flexible installation)

PUR/PVC yellow [140]

Cable type	PUR/PVC yellow
Cable type (abbreviation)	140
Cable abbreviation	LiYY-11Y
UL AWM style	20549
Conductor cross section	0.34 mm ²
AWG signal line	22
Conductor structure signal line	42x 0.10 mm
Core diameter including insulation	1.5 mm ±0.05 mm
Thickness, insulation	approx. 0.3 mm (Core insulation)
	≥ 0.38 mm (Outer cable sheath)
	approx. 0.35 mm (Inner sheath)
Wire colors	brown, white, blue, black
Overall twist	4 wires, twisted
External sheath, color	yellow
External cable diameter D	5.2 mm ±0.2 mm
Smallest bending radius, fixed installation	52 mm
Smallest bending radius, movable installation	52 mm
Number of bending cycles	2000000
Bending radius	52 mm
Traversing path	5 m
Traversing rate	3 m/s
Cable weight	39 kg/km
Outer sheath, material	PUR
Material, inner sheath	PVC
Material conductor insulation	PVC
Conductor material	Bare Cu litz wires
Insulation resistance	≥ 1 GΩ*km (at 20 °C)
Conductor resistance	max. 58 Ω/km (at 20 °C)
Nominal voltage, cable	≤ 300 V
Test voltage, cable	≥ 3000 V
Flame resistance	in accordance with DIN UL-Style 20549
Ambient temperature (operation)	-25 °C ... 80 °C (cable, fixed installation)

Sensor/actuator cable - SAC-4P-M12MR-M12FS/.../... - 1697030

Technical data

PUR/PVC yellow [140]

	-5 °C ... 80 °C (cable, flexible installation)
--	--

PUR irradiated halogen-free orange [150]

Cable type	PUR irradiated halogen-free orange
Cable type (abbreviation)	150
Cable abbreviation	D12YSL11X-OB
Conductor cross section	4x 0.34 mm ²
AWG signal line	22
Conductor structure signal line	19x 0.15 mm
Core diameter including insulation	1.05 mm ±0.05 mm (Signal line)
Wire colors	brown, white, blue, black
Overall twist	4 wires, twisted
Length of twist, overall twist	27 mm
External sheath, color	orange RAL 2003
External cable diameter D	5.2 mm ±0.2 mm
Smallest bending radius, fixed installation	min. 15 mm
Smallest bending radius, movable installation	min. 30 mm
Number of bending cycles	5000000
Bending radius	52 mm
Traversing path	10 m
Traversing rate	3 m/s
Torsion force	± 360 °/m
Outer sheath, material	PUR
Material conductor insulation	PE
Conductor material	Bare Cu litz wires
Conductor resistance	max. 57 Ω/km
Nominal voltage, cable	320 V (AC)
Test voltage, cable	2500 V (50 Hz, 5 minutes)
Special properties	Silicone-free
	Irradiated
Halogen-free	The cable is halogen-free
Other resistance	hydrolysis and microbe resistant
	Resistant to welding splashes
Ambient temperature (operation)	-50 °C ... 105 °C (cable, fixed installation)
	-40 °C ... 105 °C (cable, flexible installation)

PUR irradiated halogen-free yellow [160]

Cable type	PUR irradiated halogen-free yellow
Cable type (abbreviation)	160
Cable abbreviation	D12YSL11X-OB
Conductor cross section	4x 0.34 mm ² (Signal line)
AWG signal line	22

Sensor/actuator cable - SAC-4P-M12MR-M12FS/.../... - 1697030

Technical data

PUR irradiated halogen-free yellow [160]

Conductor structure signal line	19x 0.15 mm
Core diameter including insulation	1.05 mm ±0.05 mm (Signal line)
Wire colors	brown, white, blue, black
Overall twist	4 wires, twisted
Length of twist, overall twist	27 mm
External sheath, color	yellow
External cable diameter D	5.2 mm ±0.2 mm
Smallest bending radius, fixed installation	min. 15 mm
Smallest bending radius, movable installation	min. 30 mm
Number of bending cycles	5000000
Bending radius	52 mm
Traversing path	10 m
Traversing rate	3 m/s
Torsion force	360 °/m
Outer sheath, material	PUR
Material conductor insulation	PE
Conductor material	Bare Cu litz wires
Conductor resistance	≤ 57 Ω/km
Nominal voltage, cable	320 V AC
Test voltage, cable	2500 V AC (50 Hz, 5 minutes)
Special properties	Silicone-free
	Irradiated
Flame resistance	DIN VDE 0472 part 804, test type B
Halogen-free	The cable is halogen-free
Other resistance	hydrolysis and microbe resistant
Ambient temperature (operation)	-50 °C ... 105 °C (cable, fixed installation)
	-40 °C ... 105 °C (cable, flexible installation)

PUR halogen-free orange [180]

Cable type	PUR halogen-free orange
Cable type (abbreviation)	180
Cable abbreviation	Li9Y-11Y
UL AWM style	20549
Conductor cross section	4x 0.34 mm ² (Signal line)
AWG signal line	22
Conductor structure signal line	42x 0.10 mm
Core diameter including insulation	1.27 mm ±0.02 mm (Signal line)
Thickness, insulation	≥ 0.21 mm (Core insulation)
	approx. 0.8 mm (Outer cable sheath)
Wire colors	brown, white, blue, black
Overall twist	4 wires, twisted

Sensor/actuator cable - SAC-4P-M12MR-M12FS/.../... - 1697030

Technical data

PUR halogen-free orange [180]

External sheath, color	orange RAL 2003
External cable diameter D	4.7 mm ±0.15 mm
Smallest bending radius, fixed installation	23.5 mm
Smallest bending radius, movable installation	47 mm
Number of bending cycles	4000000
Bending radius	47 mm
Traversing path	10 m
Traversing rate	3 m/s
Acceleration	10 m/s ²
Cable weight	30 kg/km
Outer sheath, material	PUR
Material conductor insulation	PP
Conductor material	Bare Cu litz wires
Insulation resistance	≥ 1 GΩ*km (at 20 °C)
Conductor resistance	max. 58 Ω/km (at 20 °C)
Nominal voltage, cable	≤ 300 V
Test voltage, cable	≥ 3000 V
Special properties	Free of substances which would hinder coating with paint or varnish
Flame resistance	in accordance with UL 758/1581 FT2
Halogen-free	in accordance with DIN VDE 0472 part 815
	in accordance with DIN EN 50267-2-1
Resistance to oil	in accordance with DIN EN 60811-2-1
Other resistance	Resistant to salt water
	hydrolysis and microbe resistant
Ambient temperature (operation)	-40 °C ... 80 °C (cable, fixed installation)
	-25 °C ... 80 °C (cable, flexible installation)

PUR POWER 0.75 mm² black [186]

Cable type	PUR POWER 0.75 mm ² black
Cable type (abbreviation)	186
Cable abbreviation	LiY11Y
UL AWM style	20549 / 1061 (80°C/300 V)
Conductor cross section	4x 0.75 mm ² (power line)
AWG signal line	18
Conductor structure signal line	42x 0.15 mm
Core diameter including insulation	1.75 mm ±0.05 mm
Thickness, insulation	≥ 0.23 mm (Core insulation)
	≥ 0.76 mm (Outer cable sheath)
Wire colors	brown, white, blue, black
Overall twist	4 wires, twisted
External sheath, color	black-gray RAL 7021

Sensor/actuator cable - SAC-4P-M12MR-M12FS/.../... - 1697030

Technical data

PUR POWER 0.75 mm² black [186]

External cable diameter D	5.9 mm ±0.15 mm
Smallest bending radius, movable installation	59 mm
Minimum bending radius, fixed installation	5 x D
Minimum bending radius, flexible installation	10 x D
Number of bending cycles	2000000
Bending radius	59 mm
Traversing path	5 m
Traversing rate	3 m/s
Acceleration	5 m/s ²
Cable weight	57 kg/km
Outer sheath, material	PUR
Material conductor insulation	PVC
Conductor material	Bare Cu litz wires
Insulation resistance	≥ 1 MΩ*km (at 20 °C)
Conductor resistance	max. 26 Ω/km (at 20 °C)
Nominal voltage, cable	≤ 300 V
Test voltage, cable	≥ 3000 V
Flame resistance	according to UL 758/1581 (horizontal) in accordance with UL 758/1581 FT2
Resistance to oil	According to DIN EN 60811-2-1, 168 h at 100°C
Other resistance	hydrolysis and microbe resistant Low adhesion abrasion-resistant Resistant to salt water
Ambient temperature (operation)	-25 °C ... 80 °C (cable, fixed installation) -5 °C ... 80 °C (cable, flexible installation)

PUR halogen-free yellow [240]

Cable type	PUR halogen-free yellow
Cable type (abbreviation)	240
Cable abbreviation	Li9Y11Y
Conductor cross section	4x 0.34 mm ²
AWG signal line	22
Conductor structure signal line	42x 0.10 mm
Core diameter including insulation	1.27 mm ±0.02 mm
Thickness, insulation	≥ 0.21 mm (Core insulation) approx. 0.8 mm (Outer cable sheath)
Wire colors	brown, white, blue, black
Overall twist	4 wires, twisted
Length of twist, overall twist	49.5 mm
External sheath, color	yellow

Sensor/actuator cable - SAC-4P-M12MR-M12FS/.../... - 1697030

Technical data

PUR halogen-free yellow [240]

External cable diameter D	4.7 mm ±0.15 mm
Smallest bending radius, fixed installation	23.5 mm
Smallest bending radius, movable installation	47 mm
Number of bending cycles	4000000
Bending radius	47 mm
Traversing path	10 m
Traversing rate	3 m/s
Acceleration	10 m/s ²
Cable weight	30 kg/km
Outer sheath, material	PUR
Material conductor insulation	PP
Conductor material	Bare Cu litz wires
Insulation resistance	≥ 1 GΩ*km (at 20 °C)
Conductor resistance	max. 58 Ω/km (at 20 °C)
Nominal voltage, cable	≤ 300 V
Test voltage, cable	≥ 3000 V
Special properties	Flexible cable conduit capable
	Silicone-free
	Free of substances which would hinder coating with paint or varnish
Flame resistance	in accordance with DIN UL-Style 20549
	in accordance with FT1 as per UL 758
Halogen-free	in accordance with DIN VDE 0472 part 815
	in accordance with DIN EN 50267-2-1
Resistance to oil	in accordance with DIN EN 60811-2-1
Other resistance	Highly resistant to acids, alkaline solutions and solvents
	hydrolysis and microbe resistant
Ambient temperature (operation)	-40 °C ... 80 °C (cable, fixed installation)
	-25 °C ... 80 °C (cable, flexible installation)

PUR halogen-free gray [280]

Cable type	PUR halogen-free gray
Cable type (abbreviation)	280
Cable abbreviation	Li9Y11Y
Conductor cross section	0.34 mm ²
AWG signal line	22
Conductor structure signal line	42x 0.10 mm
Core diameter including insulation	1.27 mm ±0.02 mm
Thickness, insulation	≥ 0.21 mm (Core insulation)
	approx. 0.8 mm (Outer cable sheath)
Wire colors	brown, white, blue, black
Overall twist	4 wires, twisted

Sensor/actuator cable - SAC-4P-M12MR-M12FS/.../... - 1697030

Technical data

PUR halogen-free gray [280]

Length of twist, overall twist	49.5 mm
External sheath, color	gray RAL 7001
External cable diameter D	4.7 mm ±0.15 mm
Smallest bending radius, fixed installation	23.5 mm
Smallest bending radius, movable installation	47 mm
Number of bending cycles	4000000
Bending radius	47 mm
Traversing path	10 m
Traversing rate	3 m/s
Acceleration	10 m/s ²
Cable weight	30 kg/km
Outer sheath, material	PUR
Material conductor insulation	PP
Conductor material	Bare Cu litz wires
Insulation resistance	≥ 100 MΩ*km
Conductor resistance	max. 58 Ω/km (at 20 °C)
Nominal voltage, cable	≤ 300 V
Test voltage, cable	≥ 3000 V
Special properties	Flexible cable conduit capable
	Silicone-free
	Free of substances which would hinder coating with paint or varnish
Flame resistance	in accordance with DIN UL-Style 20549
	in accordance with FT1 as per UL 758
Halogen-free	in accordance with DIN VDE 0472 part 815
	in accordance with DIN EN 50267-2-1
Resistance to oil	in accordance with DIN EN 60811-2-1
Other resistance	Highly resistant to acids, alkaline solutions and solvents
	hydrolysis and microbe resistant
Ambient temperature (operation)	-40 °C ... 80 °C (cable, fixed installation)
	-25 °C ... 80 °C (cable, flexible installation)

PVC gray [500]

Cable type	PVC gray
Cable type (abbreviation)	500
Cable abbreviation	LiYY
Conductor cross section	0.34 mm ²
AWG signal line	22
Conductor structure signal line	42x 0.10 mm
Core diameter including insulation	1.45 mm ±0.02 mm
Thickness, insulation	≥ 0.23 mm (Core insulation)
	≥ 0.76 mm (Outer cable sheath)

Sensor/actuator cable - SAC-4P-M12MR-M12FS/.../... - 1697030

Technical data

PVC gray [500]

Wire colors	brown, white, blue, black
Overall twist	4 wires, twisted
External sheath, color	gray RAL 7001
External cable diameter D	5.2 mm ±0.15 mm
Smallest bending radius, fixed installation	26 mm
Smallest bending radius, movable installation	52 mm
Cable weight	40 kg/km
Outer sheath, material	PVC
Material conductor insulation	PVC
Conductor material	Bare Cu litz wires
Insulation resistance	≥ 1 GΩ*km (at 20 °C)
Conductor resistance	max. 58 Ω/km (at 20 °C)
Nominal voltage, cable	≤ 300 V (AC)
Test voltage, cable	≥ 3000 V (AC)
Flame resistance	in accordance with FT1 as per UL 758
Resistance to oil	in accordance with DIN EN 60811-2-1
Ambient temperature (operation)	-40 °C ... 80 °C (cable, fixed installation)
	-25 °C ... 80 °C (cable, flexible installation)

PVC yellow [540]

Cable type	PVC yellow
Cable type (abbreviation)	540
Cable abbreviation	LiYY
Conductor cross section	0.34 mm ²
AWG signal line	22
Conductor structure signal line	42x 0.10 mm
Core diameter including insulation	1.45 mm ±0.05 mm
Thickness, insulation	≥ 0.23 mm (Core insulation)
	≥ 0.76 mm (Outer cable sheath)
Wire colors	brown, white, blue, black
Overall twist	4 wires, twisted
External sheath, color	yellow
External cable diameter D	5.2 mm ±0.15 mm
Cable weight	40 kg/km
Outer sheath, material	PVC
Material conductor insulation	PVC
Conductor material	Bare Cu litz wires
Insulation resistance	≥ 1 GΩ*km (at 20 °C)
Conductor resistance	max. 58 Ω/km (at 20 °C)
Nominal voltage, cable	≤ 300 V (AC)
Test voltage, cable	≥ 3000 V

Sensor/actuator cable - SAC-4P-M12MR-M12FS/.../... - 1697030

Technical data

PVC yellow [540]

Flame resistance	As per UL-Style 2464
	according to UL 758/1581 FT1
Resistance to oil	in accordance with DIN EN 60811-2-1
Ambient temperature (operation)	-40 °C ... 80 °C (cable, fixed installation)
	-25 °C ... 80 °C (cable, flexible installation)

PVC yellow 105 °C [542]

Cable type	PVC yellow 105 °C
Cable type (abbreviation)	542
Cable abbreviation	LiYY
Conductor cross section	0.34 mm ²
AWG signal line	22
Conductor structure signal line	42x 0.10 mm
Core diameter including insulation	1.55 mm ±0.05 mm
Thickness, insulation	≥ 0.38 mm (Core insulation)
	≥ 0.76 mm (Outer cable sheath)
Wire colors	brown, white, blue, black
Overall twist	4 wires, twisted
External sheath, color	yellow
External cable diameter D	5.5 mm ±0.2 mm
Cable weight	43 kg/km
Outer sheath, material	PVC
Material conductor insulation	PVC
Conductor material	Bare Cu litz wires
Insulation resistance	≥ 100 MΩ*km (at 20 °C)
Conductor resistance	≤ 58 Ω/km (at 20 °C)
Nominal voltage, cable	≤ 300 V
Test voltage, cable	≥ 3000 V
Flame resistance	in accordance with UL-Style 2517
	in acc. to UL VW1
Ambient temperature (operation)	-25 °C ... 105 °C (cable, fixed installation)

Gray, highly flexible PUR [800]

Note	Due to the extremely robust outer sheath, this cable should only be stripped in 5 cm increments.
Cable type	Gray, highly flexible PUR
Cable type (abbreviation)	800
Cable abbreviation	Li12YYTPE-HF
UL AWM style	20233
Conductor cross section	4x 0.34 mm ² (Signal line)
AWG signal line	22
Conductor structure signal line	42x 0.10 mm

Sensor/actuator cable - SAC-4P-M12MR-M12FS/.../... - 1697030

Technical data

Gray, highly flexible PUR [800]

Core diameter including insulation	1.3 mm ±0.05 mm (Signal line)
Wire colors	brown, white, blue, black
Overall twist	4 wires, twisted
External sheath, color	gray RAL 7001
External cable diameter D	4.8 mm ±0.2 mm
Minimum bending radius, fixed installation	4 x D
Minimum bending radius, flexible installation	7.5 x D
Number of bending cycles	10000000
Minimum bending radius, drag chain applications	7,5 x D
Traversing path	5 m
Traversing rate	3.3 m/s
Acceleration	5 m/s ²
Number of bending cycles	15000000
Bending radius	50 mm
Traversing path	0.9 m
Traversing rate	5 m/s
Acceleration	30 m/s ²
Torsion force	± 360 °/m (1 000 000 torsion cycles)
Cable weight	33.5 kg/km
Outer sheath, material	PUR
Material conductor insulation	PES
Conductor material	Bare Cu litz wires
Insulation resistance	≥ 20 MΩ*km
Conductor resistance	approx. 53 Ω/km
Nominal voltage, cable	300 V
Test voltage, cable	2000 V
Special properties	Cable jacket is welding spark-resistant, recyclable, matt, low-adhesion, abrasion-resistant, flame-retardant, and self-extinguishing
	Free from silicone and cadmium
	Free of substances which would hinder coating with paint or varnish
Flame resistance	according to IEC 60332-1-2
	according to UL 758/1581 VW-1
	according to UL 758/1581 FT1
Halogen-free	in accordance with DIN VDE 0472 part 815
Resistance to oil	According to HD 22.10
	in accordance with DIN EN 60811-404 (external sheath)
Other resistance	Highly resistant to acids, alkaline solutions and solvents
	Silicone-free
Ambient temperature (operation)	-40 °C ... 90 °C (cable, fixed installation)
	-30 °C ... 90 °C (cable, flexible installation)
	to 120 °C (for 3000 h)

Sensor/actuator cable - SAC-4P-M12MR-M12FS/.../... - 1697030

Technical data

PUR halogen-free black [PUR]

Cable type	PUR halogen-free black
Cable type (abbreviation)	PUR
Cable abbreviation	Li9Y11Y-HF
UL AWM style	20549 / 10493 (80°C/300 V)
Conductor cross section	4x 0.34 mm ²
AWG signal line	22
Conductor structure signal line	42x 0.10 mm
Core diameter including insulation	1.27 mm ±0.02 mm
Thickness, insulation	≥ 0.21 mm
Wire colors	brown, white, blue, black
Overall twist	4 wires, twisted
External sheath, color	black-gray RAL 7021
Outer sheath thickness	approx. 0.5 mm
External cable diameter D	4.2 mm ±0.15 mm
Minimum bending radius, fixed installation	5 x D
Minimum bending radius, flexible installation	10 x D
Number of bending cycles	10000000
Minimum bending radius, drag chain applications	10 x D
Traversing path	10 m
Traversing rate	3 m/s
Acceleration	10 m/s ²
Cable weight	30 kg/km
Outer sheath, material	PUR
Material conductor insulation	PP
Conductor material	Bare Cu litz wires
Insulation resistance	≥ 1 GΩ*km
Conductor resistance	≤ 58 Ω/km
Nominal voltage, cable	≤ 300 V
Test voltage, cable	≥ 3000 V
Special properties	Flexible cable conduit capable
	Silicone-free
	Free of substances which would hinder coating with paint or varnish
	flexible
Flame resistance	in accordance with UL 758/1581 FT2
	DIN EN 60332-2-2 (20 s)
Halogen-free	in accordance with DIN VDE 0472 part 815
	in accordance with DIN EN 50267-2-1
Resistance to oil	in accordance with DIN EN 60811-2-1
Other resistance	Highly resistant to acids, alkaline solutions and solvents
	hydrolysis and microbe resistant

Sensor/actuator cable - SAC-4P-M12MR-M12FS/.../... - 1697030

Technical data

PUR halogen-free black [PUR]

	partly UV-resistant in accordance with DIN EN ISO 4892-2-A
	Low adhesion
	abrasion-resistant
Ambient temperature (operation)	-40 °C ... 80 °C (cable, fixed installation)
	-25 °C ... 80 °C (cable, flexible installation)

PVC black [PVC]

Cable type	PVC black
Cable type (abbreviation)	PVC
Cable abbreviation	LiYY
UL AWM style	2464 / 1729 (80°C/300 V)
Conductor cross section	4x 0.34 mm ² (Signal line)
AWG signal line	22
Conductor structure signal line	42x 0.10 mm
Core diameter including insulation	1.45 mm ±0.02 mm
Thickness, insulation	≥ 0.23 mm (Core insulation)
Wire colors	brown, white, blue, black
Overall twist	4 wires, twisted
External sheath, color	black RAL 9005
Outer sheath thickness	≥ 0.76 mm
External cable diameter D	5.2 mm ±0.15 mm
Minimum bending radius, fixed installation	5 x D
Minimum bending radius, flexible installation	10 x D
Cable weight	40 kg/km
Outer sheath, material	PVC
Material conductor insulation	PVC
Conductor material	Bare Cu litz wires
Insulation resistance	≥ 200 MΩ*km (at 20 °C)
Conductor resistance	max. 58 Ω/km (at 20 °C)
Nominal voltage, cable	≤ 300 V
Test voltage, cable	≥ 3000 V
Flame resistance	according to UL 758/1581 FT1
	According to UL 758/1581 (Cable Flame)
	According to DIN EN 60332-1-2
Resistance to oil	according to DIN EN 60811-2-1, 168 h at 60 °C
Ambient temperature (operation)	-40 °C ... 80 °C (cable, fixed installation)
	-25 °C ... 80 °C (cable, flexible installation)

Environmental Product Compliance

China RoHS	Environmentally friendly use period: unlimited = EFUP-e
	No hazardous substances above threshold values

Sensor/actuator cable - SAC-4P-M12MR-M12FS/.../... - 1697030

Drawings

Dimensional drawing

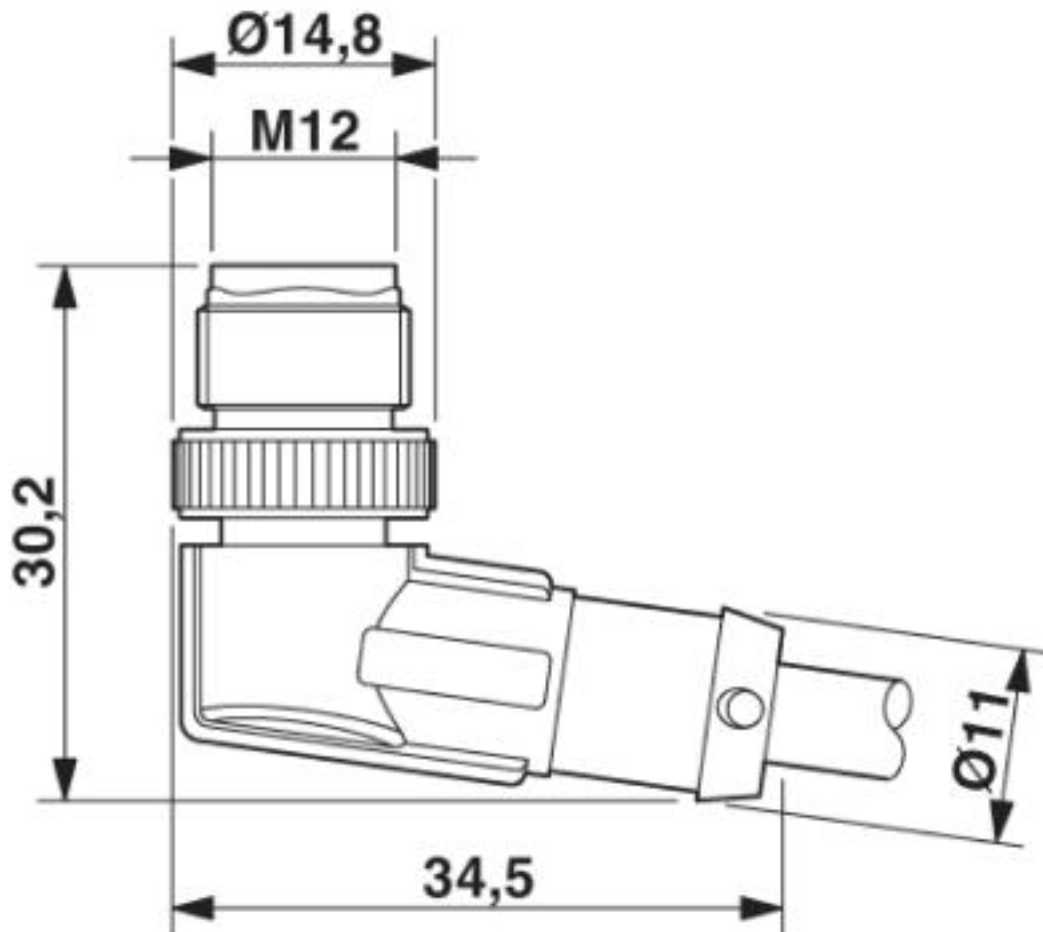

M12 x 1 male plug, angled

Sensor/actuator cable - SAC-4P-M12MR-M12FS/.../... - 1697030

Dimensional drawing

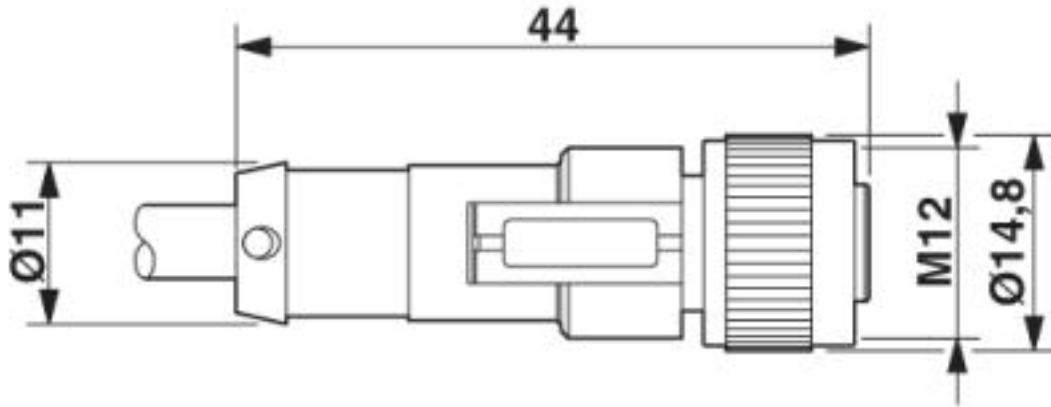

M12 x 1 socket, straight

Circuit diagram

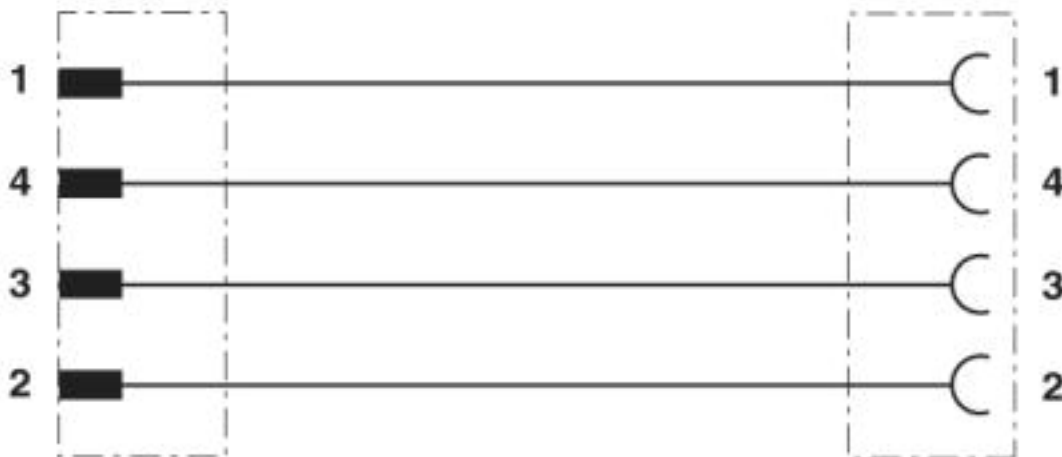

Contact assignment of the M12 plug and the M12 socket

Sensor/actuator cable - SAC-4P-M12MR-M12FS/.../... - 1697030

Schematic diagram

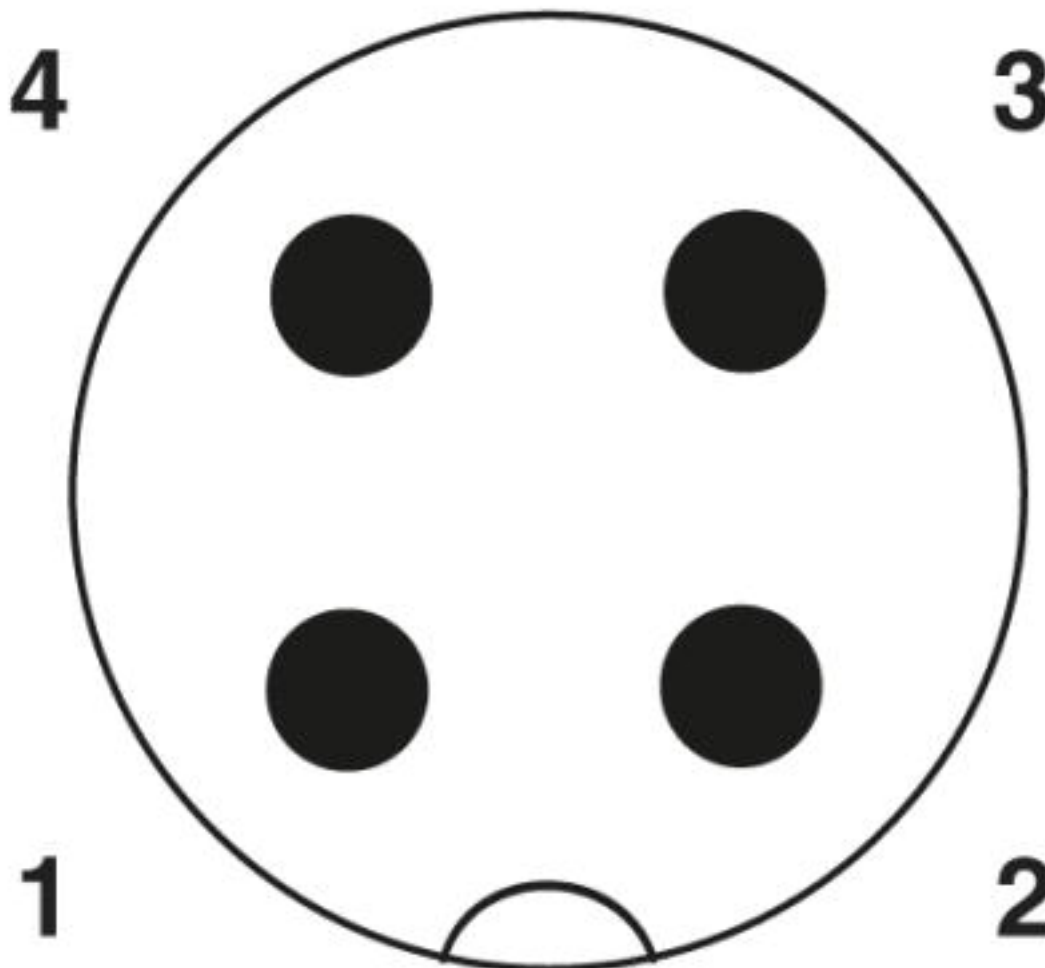

Pin assignment M12 plug, 4-pos., A-coded, view plug side

Sensor/actuator cable - SAC-4P-M12MR-M12FS/.../... - 1697030

Schematic diagram

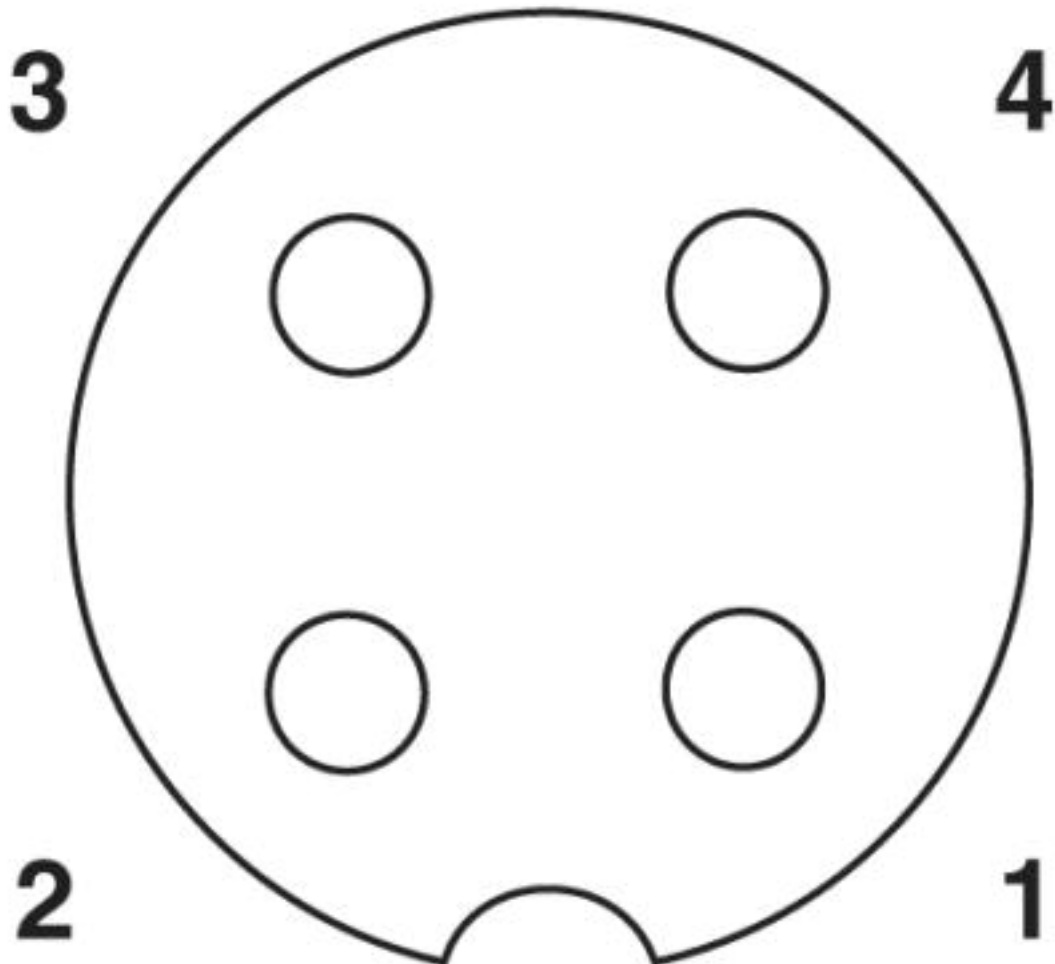

Pin assignment M12 socket, 4-pos., A-coded, view female side

Sensor/actuator cable - SAC-4P-M12MR-M12FS/.../... - 1697030

Cable cross section

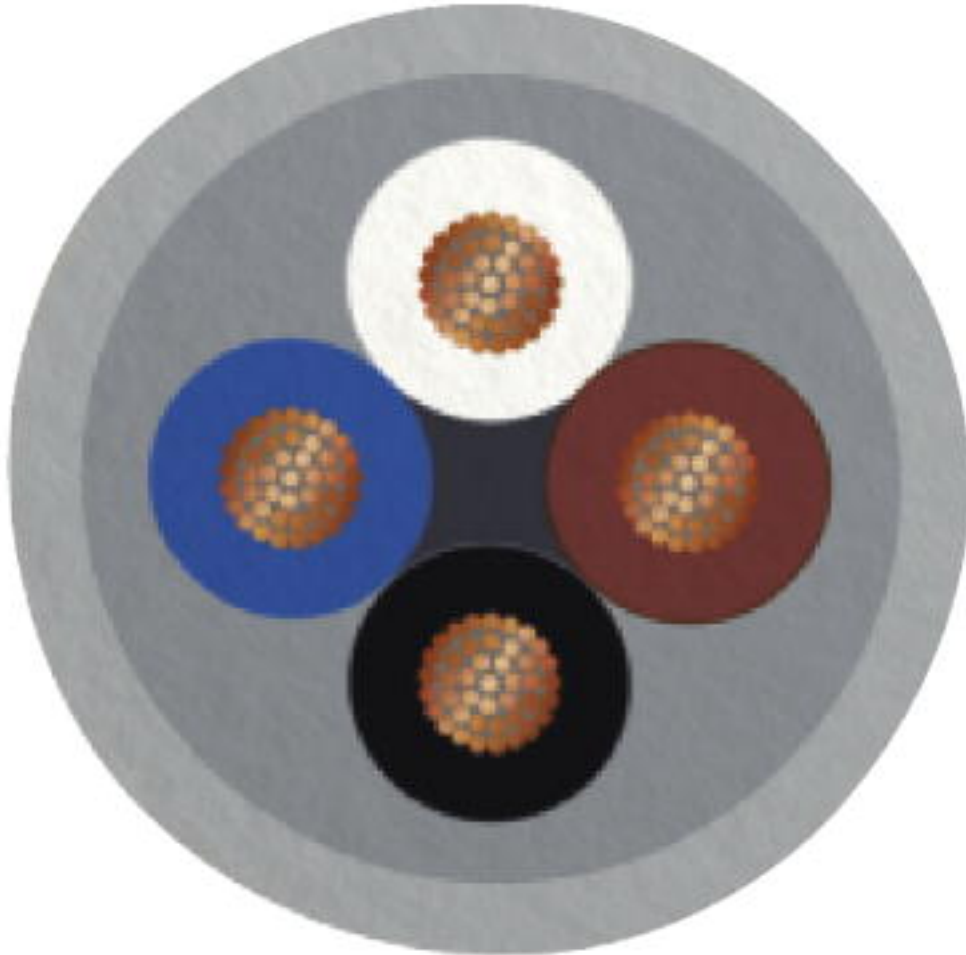

PUR/PVC gray [100]

Sensor/actuator cable - SAC-4P-M12MR-M12FS/.../... - 1697030

Cable cross section

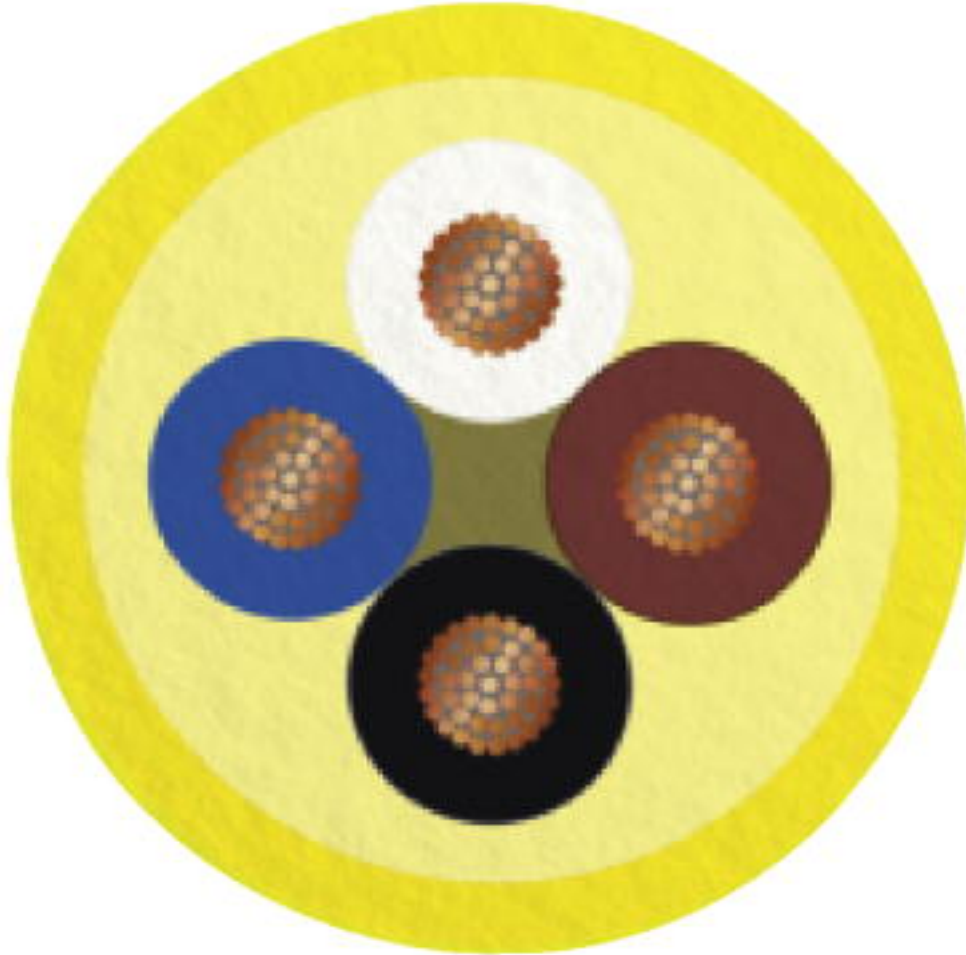

PUR/PVC yellow [140]

Sensor/actuator cable - SAC-4P-M12MR-M12FS/.../... - 1697030

Cable cross section

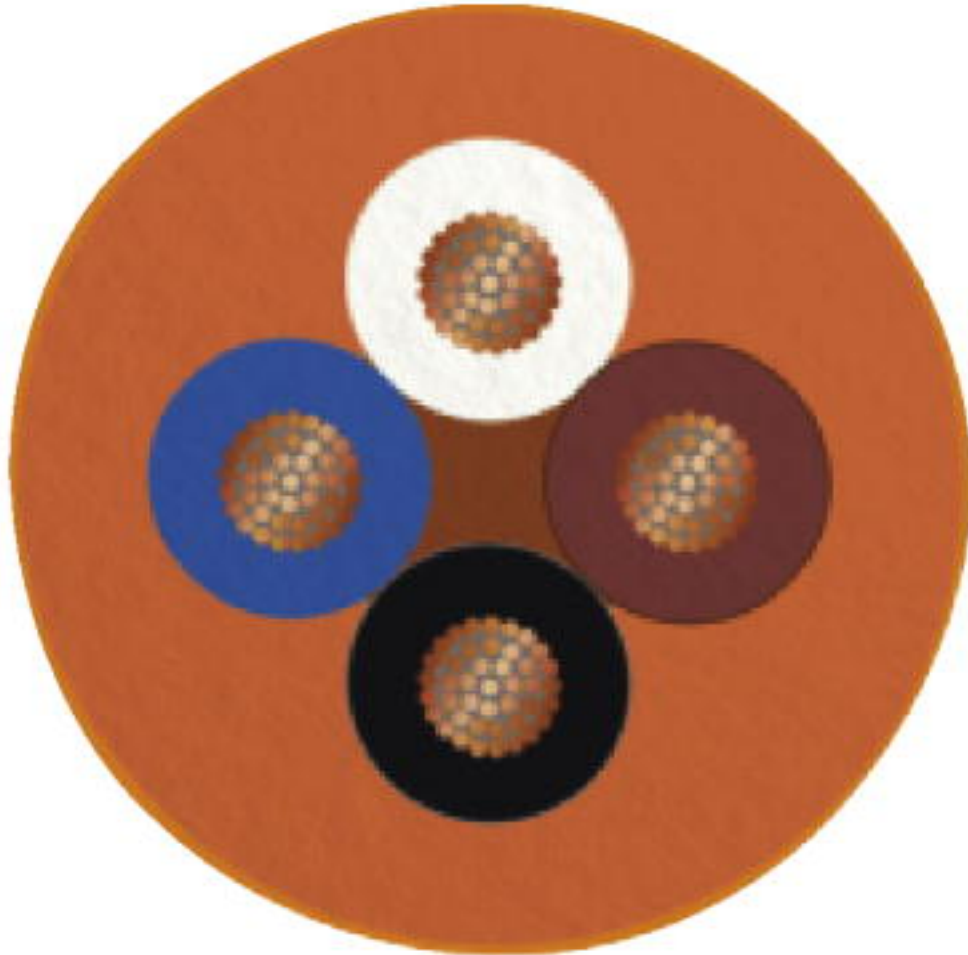

PUR irradiated halogen-free orange [150]

Sensor/actuator cable - SAC-4P-M12MR-M12FS/.../... - 1697030

Cable cross section

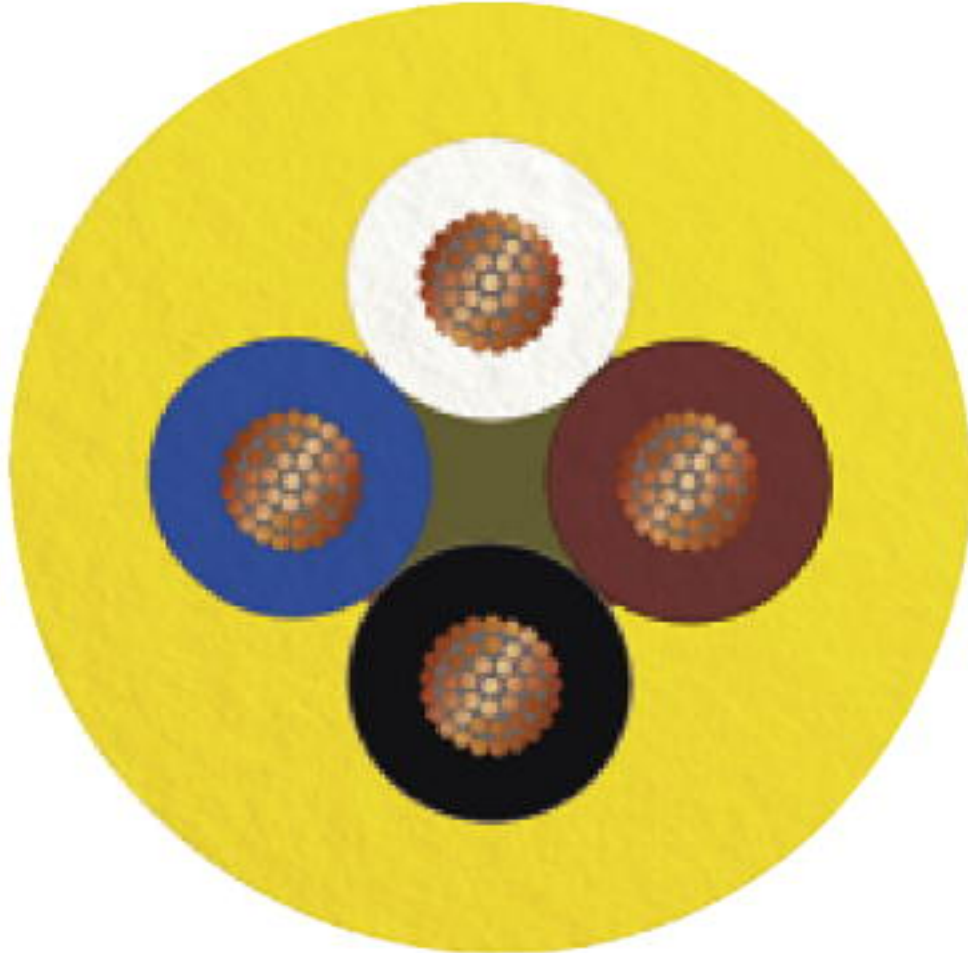

PUR irradiated halogen-free yellow [160]

Sensor/actuator cable - SAC-4P-M12MR-M12FS/.../... - 1697030

Cable cross section

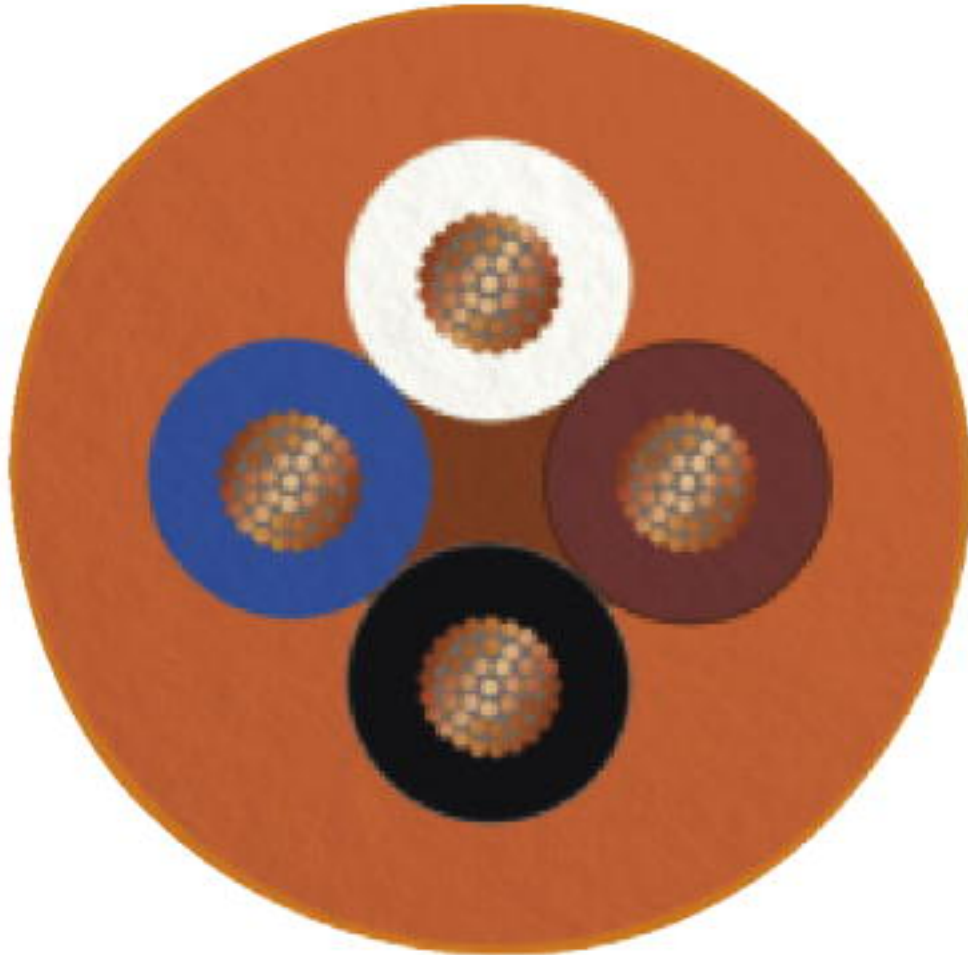

PUR halogen-free orange [180]

Sensor/actuator cable - SAC-4P-M12MR-M12FS/.../... - 1697030

Cable cross section

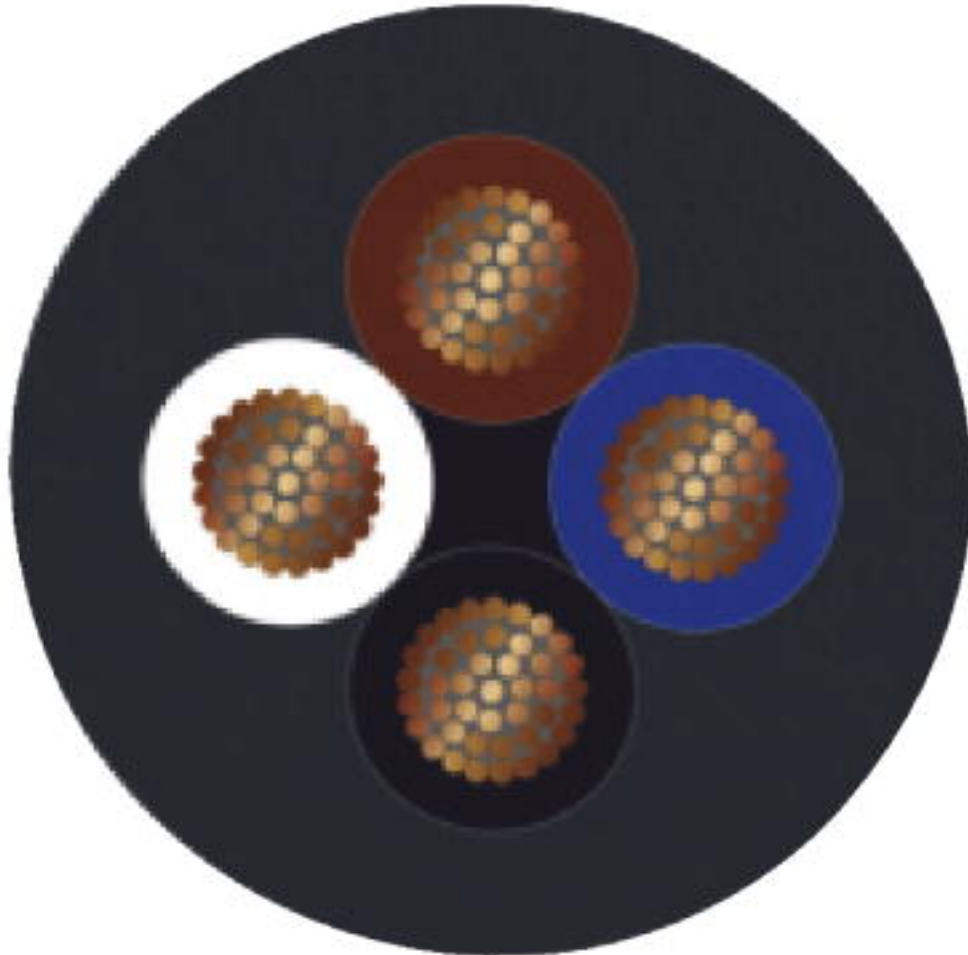

PUR POWER 0.75 mm² black [186]

Sensor/actuator cable - SAC-4P-M12MR-M12FS/.../... - 1697030

Cable cross section

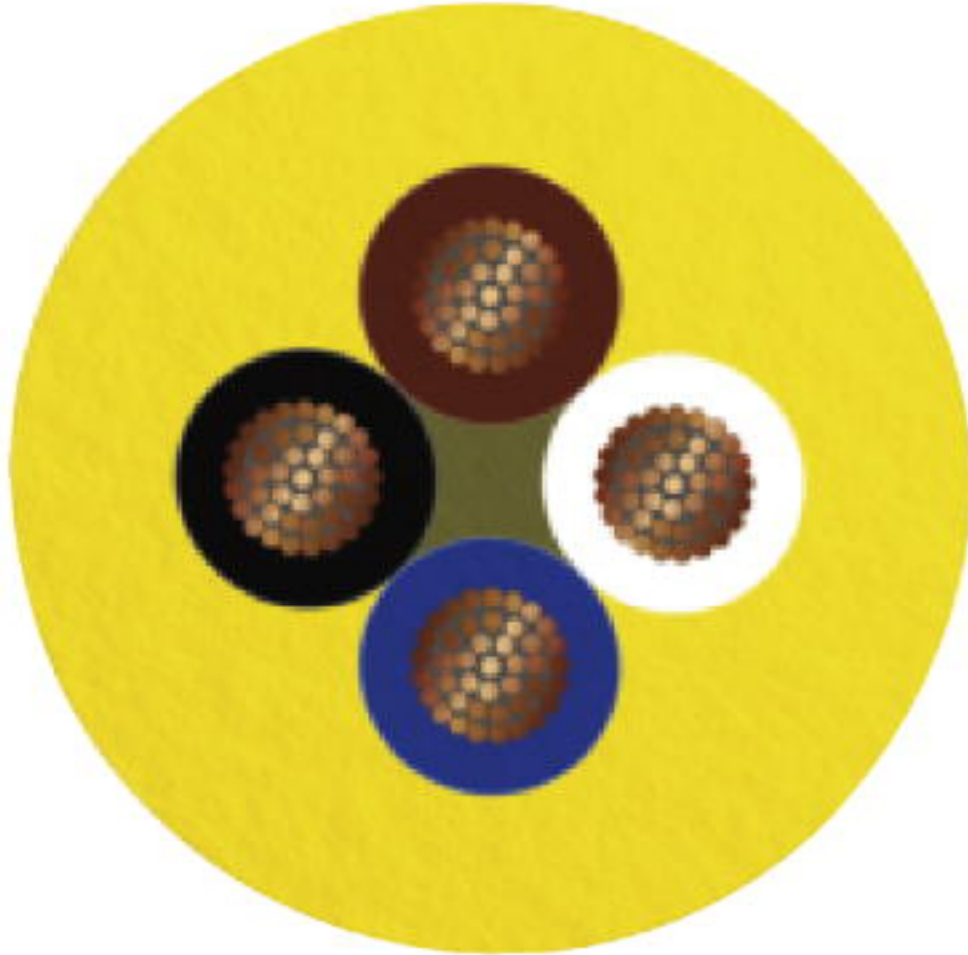

PUR halogen-free yellow [240]

Sensor/actuator cable - SAC-4P-M12MR-M12FS/.../... - 1697030

Cable cross section

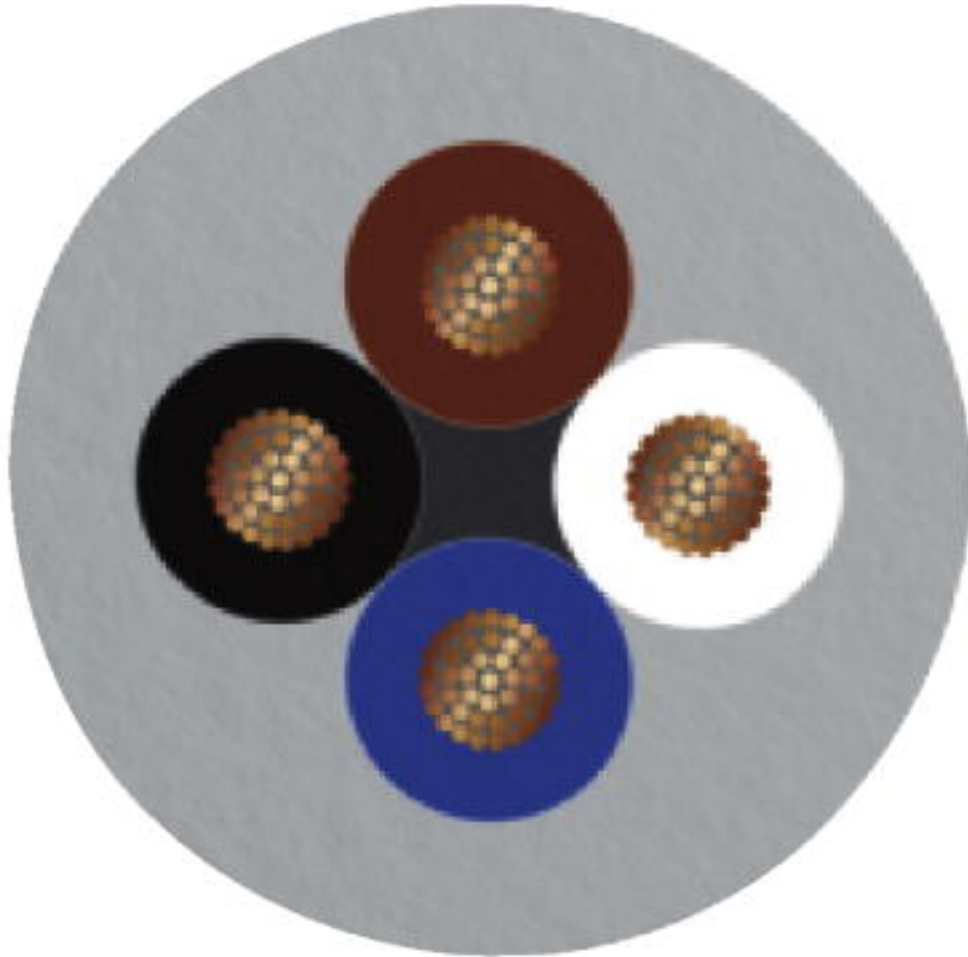

PUR halogen-free gray [280]

Sensor/actuator cable - SAC-4P-M12MR-M12FS/.../... - 1697030

Cable cross section

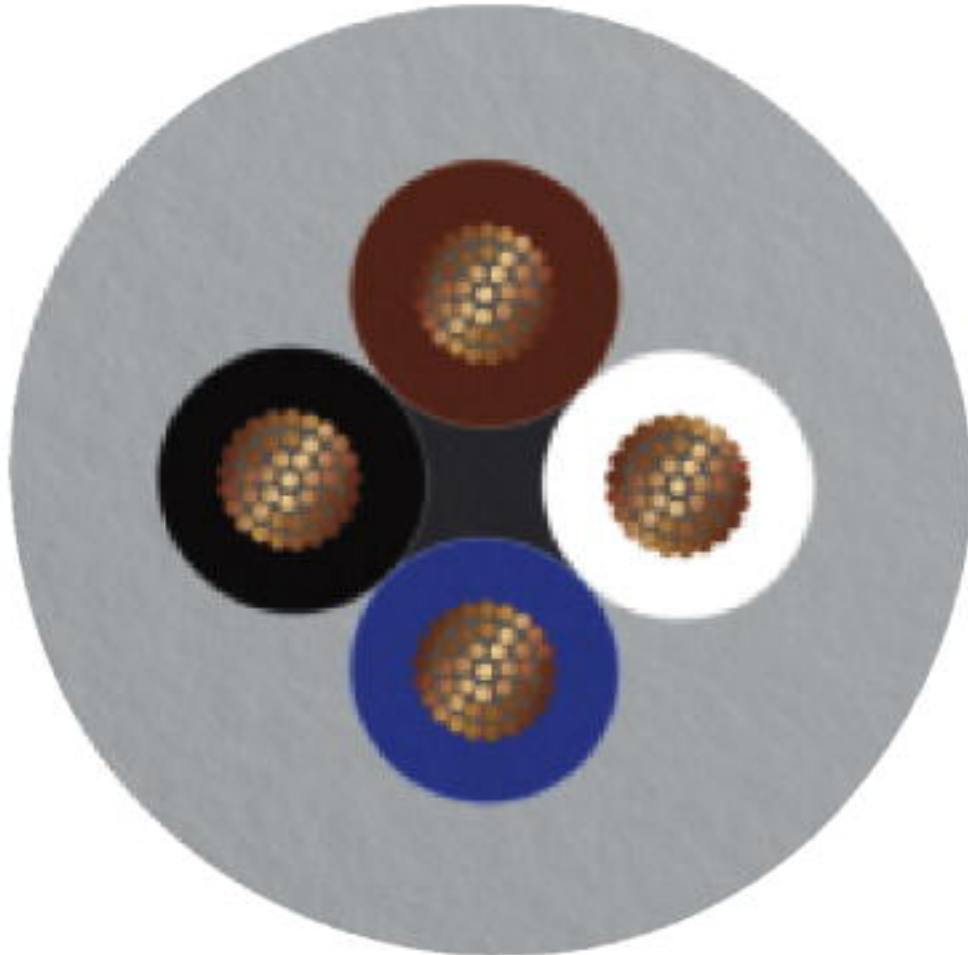

PVC gray [500]

Sensor/actuator cable - SAC-4P-M12MR-M12FS/.../... - 1697030

Cable cross section

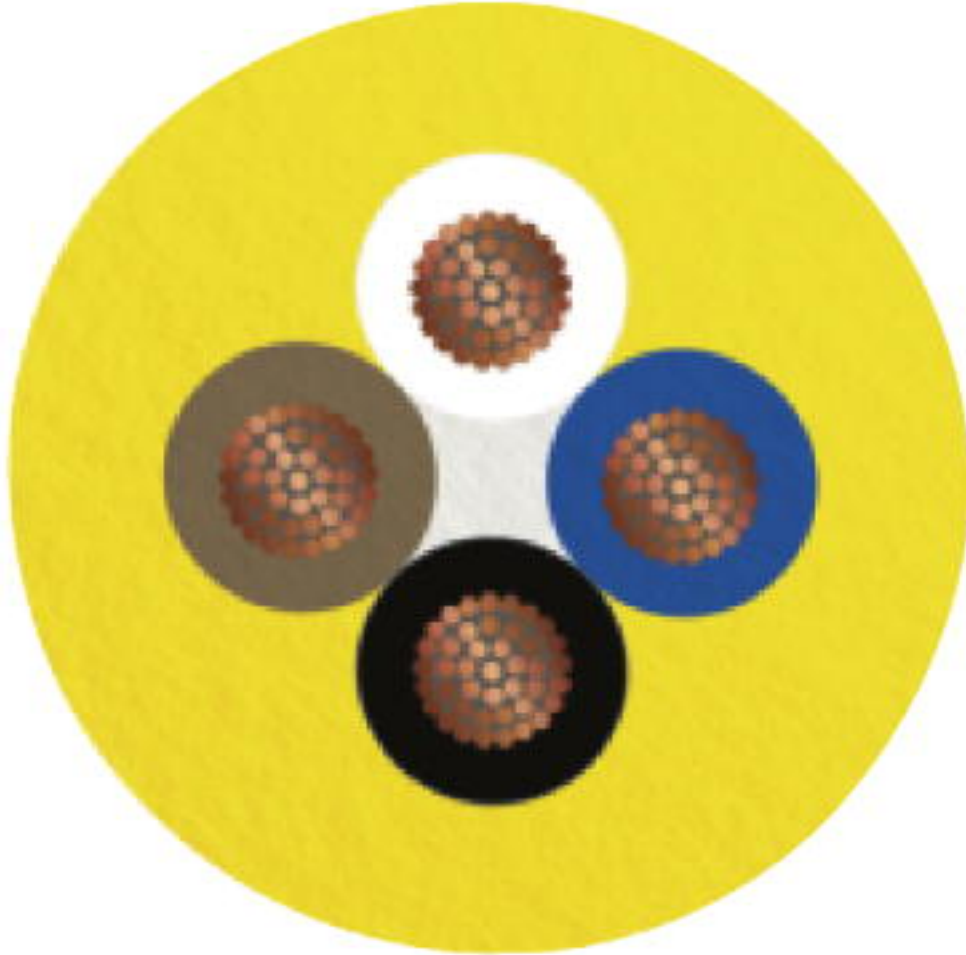

PVC yellow [540]

Sensor/actuator cable - SAC-4P-M12MR-M12FS/.../... - 1697030

Cable cross section

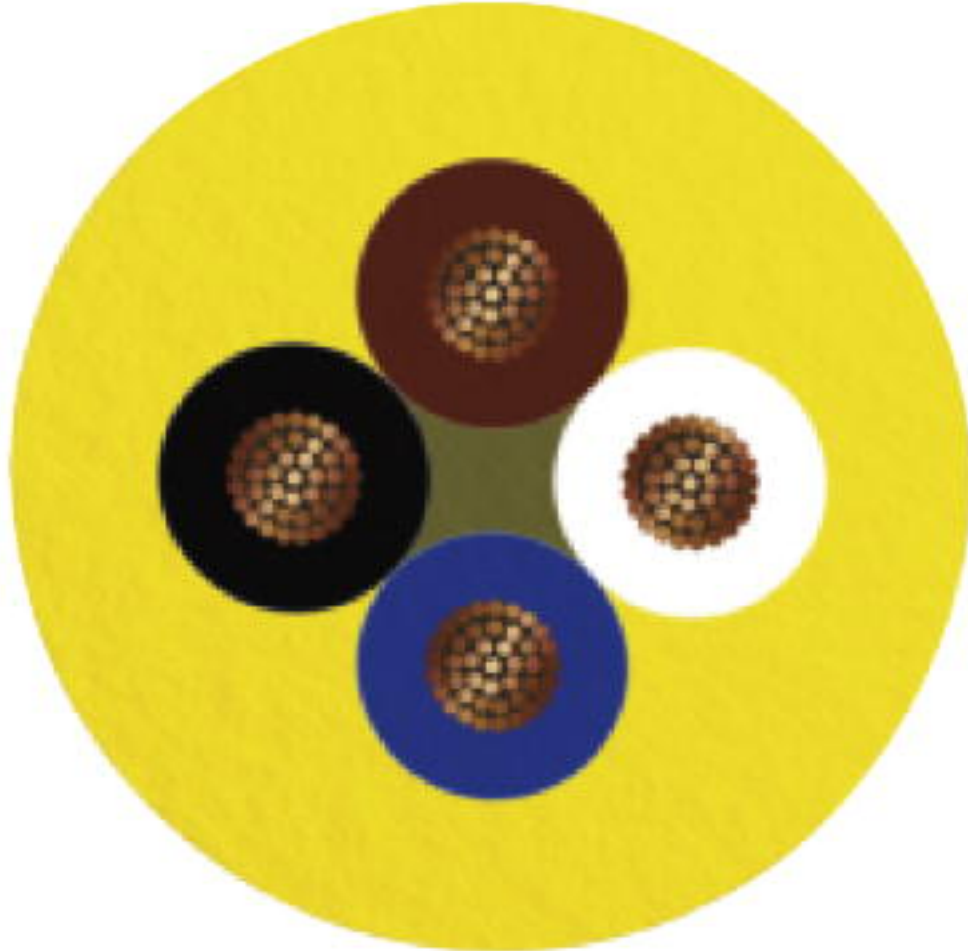

PVC yellow 105 °C [542]

Sensor/actuator cable - SAC-4P-M12MR-M12FS/.../... - 1697030

Cable cross section

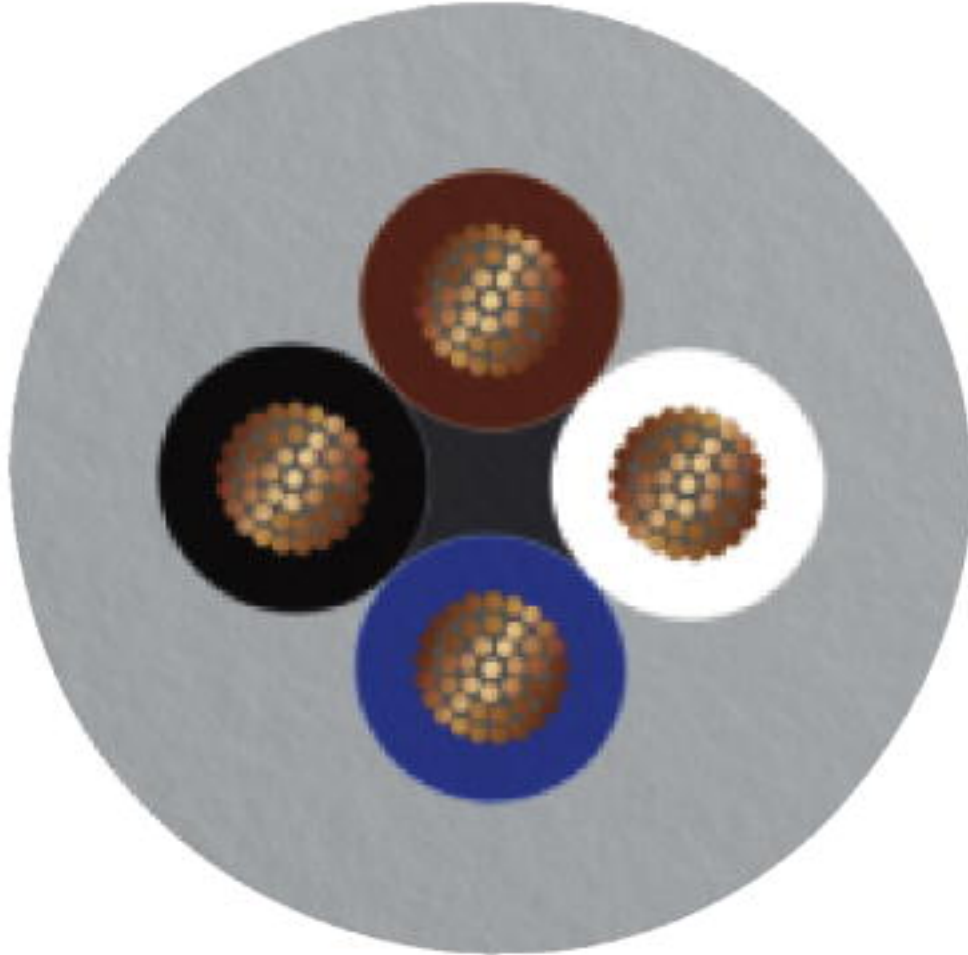

Gray, highly flexible PUR [800]

Sensor/actuator cable - SAC-4P-M12MR-M12FS/.../... - 1697030

Cable cross section

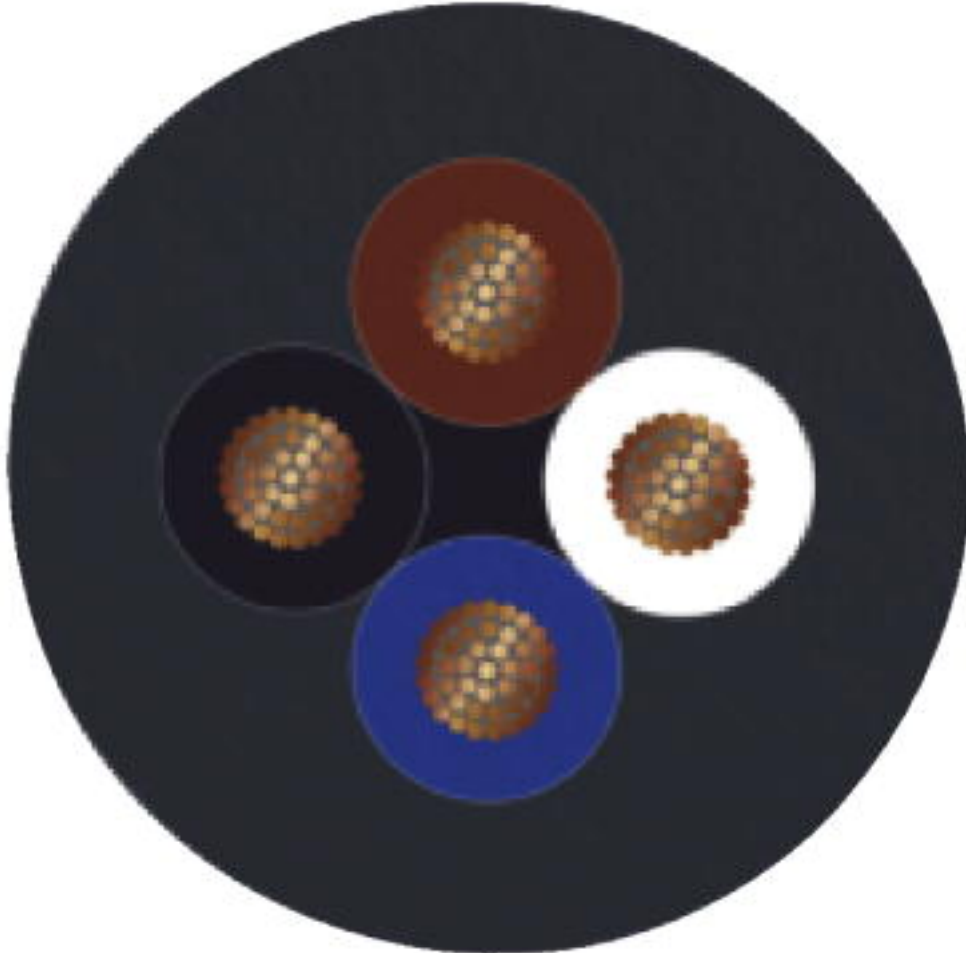

PVC black [PVC]

Approvals

Approvals

Approvals

UL Listed / cUL Listed / EAC / cULus Listed

Ex Approvals

Approval details

Sensor/actuator cable - SAC-4P-M12MR-M12FS/.../... - 1697030

Approvals

UL Listed		http://database.ul.com/cgi-bin/XYV/template/LISEXT/1FRAME/index.htm	FILE E 221474
Nominal voltage UN		300 V	
Nominal current IN		4 A	

cUL Listed		http://database.ul.com/cgi-bin/XYV/template/LISEXT/1FRAME/index.htm	FILE E 221474
Nominal voltage UN		300 V	
Nominal current IN		4 A	

EAC		RU C- DE.BL08.B.00286
-----	--	--------------------------

cULus Listed	
--------------	--

Phoenix Contact 2019 © - all rights reserved
<http://www.phoenixcontact.com>

PHOENIX CONTACT GmbH & Co. KG
Flachsmarktstr. 8
32825 Blomberg
Germany
Tel. +49 5235 300
Fax +49 5235 3 41200
<http://www.phoenixcontact.com>