



FEATURES

- Efficiency up to 92%
- Wide input range, 9V-36V
- Package Dimension:
 - Panel Mount: 100.0*56.0*19.0mm (3.94"* 2.20"*0.75")
 - DIN Rail: 118.6*67.1*23.5mm (4.67"*2.64"*0.93")
- Over voltage protection, hiccup mode
- Over current protection, hiccup mode
- Positive or Negative Remote ON/OFF
- Without tantalum capacitor inside module
- Operating Temperature range - 40°C to +85°C
- Input to Output Isolation: 1500VDC
- RoHS Compliant
- 2 Years Product Warranty
- Heat-sink is option
- EN 50155 Certified for built-in module
- IEC/EN/UL/CSA 60950-1
- IEC/EN/UL/CSA 62368-1
- CE Marked (EN 55032 and EN 55024)



The PM24S12005/DR24S12005 series are designed particularly for industrial applications where no PCB mounting is possible the module has to be mounted on a panel or din-rail. the highest power density (60W), isolated power converter. The DR24S12005/PM24S12005 series comes with a host of industry-standard features, such as over current protection, over voltage protection, over temperature protection and remote on/off. An optional heatsink is available for more extreme thermal requirements. All models have an ultra-wide 4:1 input voltage range (9V to 36V). With operating temperature of -40°C to +85°C, it is suitable for customers' critical applications, such as process control and automation, transportation, data communication and telecom equipment, test equipment, medical device and everywhere where space on the PCB is critical.

ABSOLUTE MAXIMUM RATINGS

Item	Model	Min.	Typ.	Max.	Unit
Input Continuous Voltage	All Models	0	---	36	VDC
Input Surge Voltage (100 msec)	All Models	---	---	50	VDC
Operating Ambient Temperature (With derating)	All Models	-40	---	+85	°C
Case Temperature	All Models	---	---	+100	°C
Storage Temperature	PM24S12005	-40	---	+85	°C
	DR24S12005	-40	---	+100	°C
Input/Output Isolation Voltage (rated)	All Models	---	---	1500	VDC

INPUT CHARACTERISTICS

Item	Model	Min.	Typ.	Max.	Unit
Operating Input Voltage	All Models	9	24	36	VDC
Input Turn-On Voltage Threshold	All Models	8	8.5	9	VDC
Input Turn-Off Voltage Threshold	All Models	7.2	7.7	8.2	VDC
Input Under-Voltage Lockout Hysteresis	All Models	0.2	1	1.5	VDC
Maximum Input Current	All Models, Vin=24V, Max Load	---	2695	---	mA
No-Load Input Current	All Models, Vin=24V, No Load	---	62	---	mA
Off-Converter Input Current	All Models, Vin=24V	---	10	---	mA
Reverse Polarity Input Current	All Models	---	---	0.5	A
ON/OFF Control, Logic High	All Models	2.4	---	10	VDC
ON/OFF Control, Logic Low	All Models	-0.7	---	0.8	VDC

OUTPUT CHARACTERISTICS

Item	Conditions	Min.	Typ.	Max.	Unit
Output Voltage Range	Vin=9V to 36V, Io=Open load, Tc=25°C	11.88	12	12.12	V
Output Voltage Accuracy		---	---	±1	%Vo
Load Regulation	Vin=24V	---	---	±60	mV
Line Regulation	Vin=9V to 36V	---	---	±0.2	%Vo
Total Output Voltage Range	Over Load, Line and Temperature	---	---	±3	%Vo
Ripple & Noise	Vin=24V, Full Load	---	100	---	mV _{P-P}
Dynamic load response	50%-75% full load, 0.1A/uS	---	2.5	---	%Vo
Output Current Range	Vin=9V to 36V	0	---	5000	mA
Output Over Current Protection	Output Voltage 10% Low, Hiccup	110	---	150	%Io,max
Short Output Protection	Long Term, Auto-recovery				
Output Over-Voltage Protection	Hiccup, Auto-recovery	115	---	140	%Vo
Output Trim Range	Pout ≅ max rated power, Io ≅ Io,max	-10	---	+10	%Vo
Capacitive Load	Cap ESR>=10mohm;Full load;5%overshoot of Vout at startup	---	---	6000	uF

EFFICIENCY

Item	Conditions	Min.	Typ.	Max.	Unit
Max Load	Vin=24V, Io=Full Load, Tc=25°C	---	92.3	---	%

GENERAL CHARACTERISTICS

Item	Conditions	Min.	Typ.	Max.	Unit
I/O Isolation Resistance		10	---	---	MΩ
I/O Isolation Capacitance		---	6800	---	pF
Switching Frequency		---	330	---	KHz

ENVIRONMENTAL SPECIFICATIONS

Parameter	Model	Conditions	Min.	Max.	Unit
Humidity (non condensing)	All Models		---	95	% rel. H
Altitude	All Models			2000	m
Cooling	All Models		Free-Air convection		

EMC SPECIFICATIONS

Parameter	Standards & Level	Performance
EMI	EN55022 ClassB	compliance
ESD	EN61000-4-2 air ± 8KV , Contact ± 6KV Perf. Criteria B	compliance
Radiated immunity	EN61000-4-3 20V/m Perf. Criteria A	compliance
Fast transient (See Note 5)	EN61000-4-4 ±2KV Perf. Criteria A	compliance
Surge (See Note 5)	EN61000-4-5 ±1KV Perf. Criteria A	compliance
Conducted immunity	EN61000-4-6 10V/m Perf. Criteria A	compliance

NOTES

- Specifications typical at Ta=+25°C, resistive load, nominal input voltage and rated output current unless otherwise noted.
- Ripple & Noise measurement bandwidth is 0-20MHz, with 10μF, tantalum capacitor and 1μF ceramic capacitor.
- Specifications are subject to change without notice.

ELECTRICAL CHARACTERISTICS CURVES

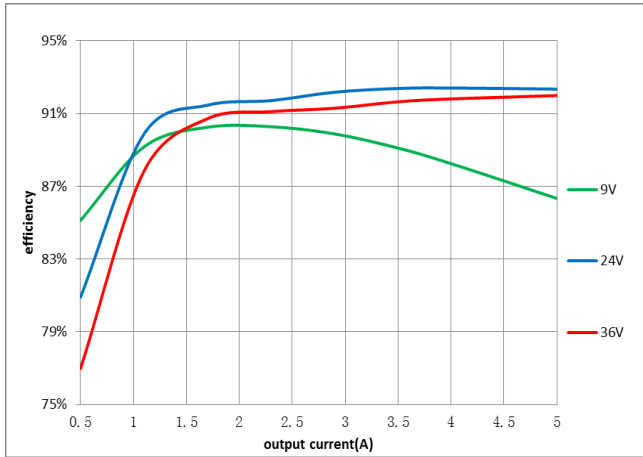

Efficiency vs. load current for various input voltage at 25°C.

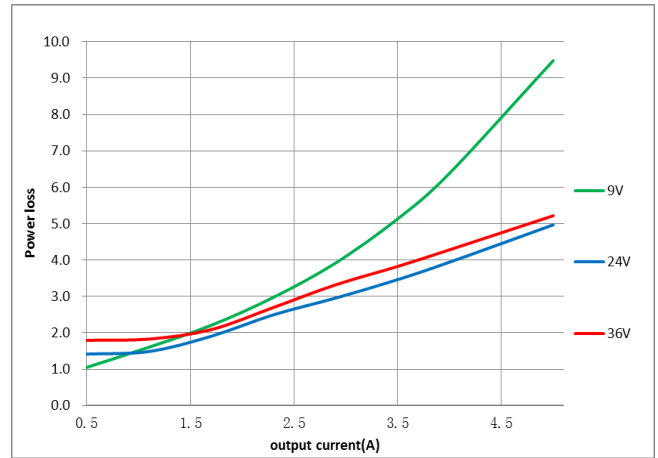

Power dissipation vs. load current at 25°C.

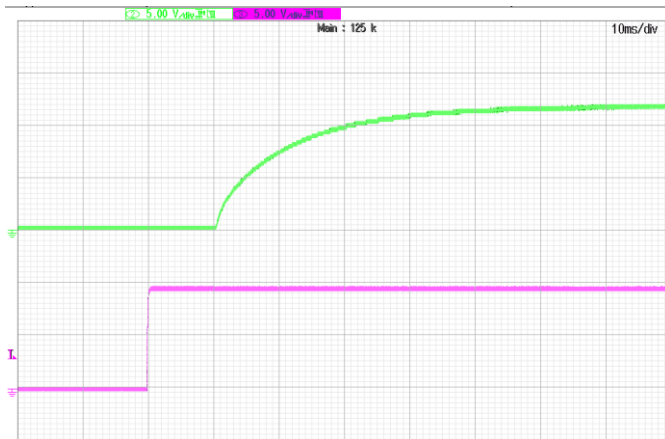

Turn-on transient at full load current (10ms/div).
Top Trace: Vout; 2V/div; Bottom Trace: ON/OFF input: 5V/div.

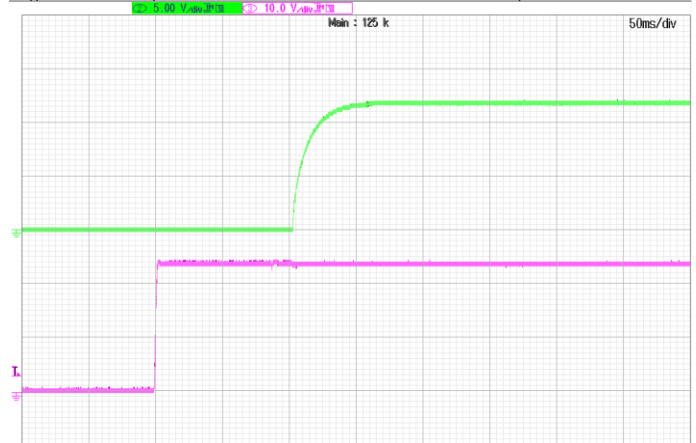

Turn-on transient at full load current (50 ms/div).
Top Trace: Vout; 2V/div; Bottom Trace: input voltage: 10V/div.

FEATURES DESCRIPTIONS

Over-Current Protection

The modules include an internal output over-current protection circuit, which will endure current limiting for an unlimited duration during output overload. If the output current exceeds the OCP set point, the modules will shut down (hiccup mode).

The modules will try to restart after shutdown. If the overload condition still exists, the module will shut down again. This restart trial will continue until the overload condition is corrected.

Over-Voltage Protection

The modules include an internal output over-voltage protection circuit, which monitors the voltage on the output terminals. If this voltage exceeds the over-voltage set point, the modules will shut down, and then restart after a hiccup-time (hiccup mode).

If latch mode is needed, please contact with Delta.

Over-Temperature Protection

The over-temperature protection consists of circuitry that provides protection from thermal damage. If the temperature exceeds the over-temperature threshold the module will shut down. The module will restart after the temperature is within specification.

Remote On/Off

The remote on/off feature on the module can be either negative or positive logic depend on the part number options on the last page.

- ❖ For Negative logic version, turns the module on during a external logic low and off during a logic high. If the remote on/off feature is not used, please short the on/off pin to Vi (-).
- ❖ For Postive logic version, turns the modules on during a external logic high and off during a logic low. If the remote on/off feature is not used, please leave the on/off pin to floating.

Remote on/off can be controlled by an external switch between the on/off terminal and the Vi (-) terminal. The switch can be an open collector or open drain.

Output Voltage Adjustment (TRIM)

Turn potentiometer on front panel:
clockwise to increase voltage value;
counter clockwise to decrease voltage value.

THERMAL CONSIDERATIONS

To enhance system reliability, the power module's case temperature should always be operated below 100°C. If the case temperature exceeds the maximum operating temperature, reliability of the unit may be affected.

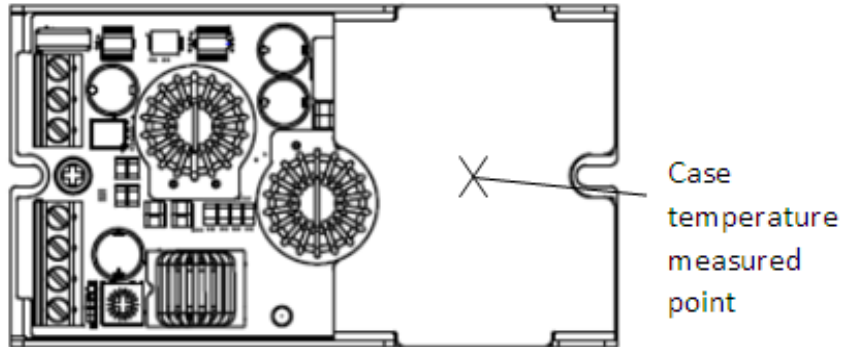

THERMAL CURVES

The module is tested in the temperature chamber under natural convection.

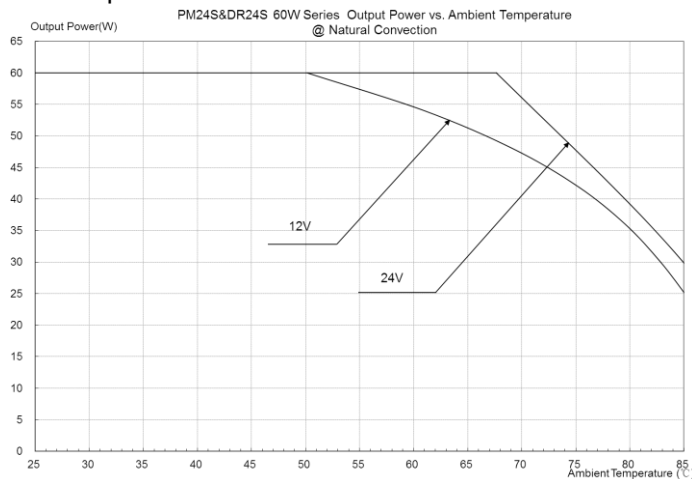
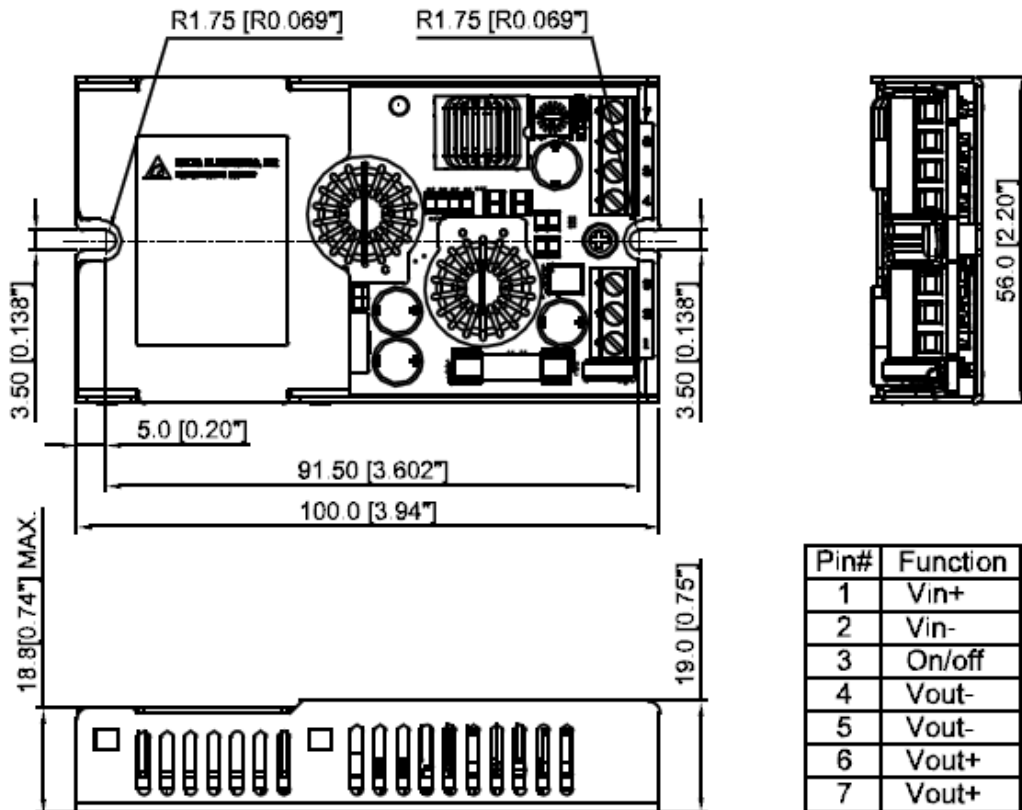

Figure1: PM24S12005&DR24S12005 60W series Output power vs Ambient temperature@Natural convection

MECHANICAL DRAWING (PANEL-MOUNT PACKAGE)

Mechanical Dimensions



Product Size: 100.0*56.0*19.0(3.94** 2.20**0.75")

Case material: Aluminum alloy

Baseplate material: Aluminum alloy

Input terminal: M3 Screw Terminal

Input wire range: 28~16 AWG

Output Terminal: M3 Screw Terminal

Output wire range: 28~16 AWG

Weight: 114 grams

- All dimensions in mm (inches)
- Tolerance: X.X±0.5 (X.XX±0.02)
X.XX±0.25 (X.XXX±0.010)

MECHANICAL DRAWING (DIN-RAIL PACKAGE)

Mechanical Dimensions

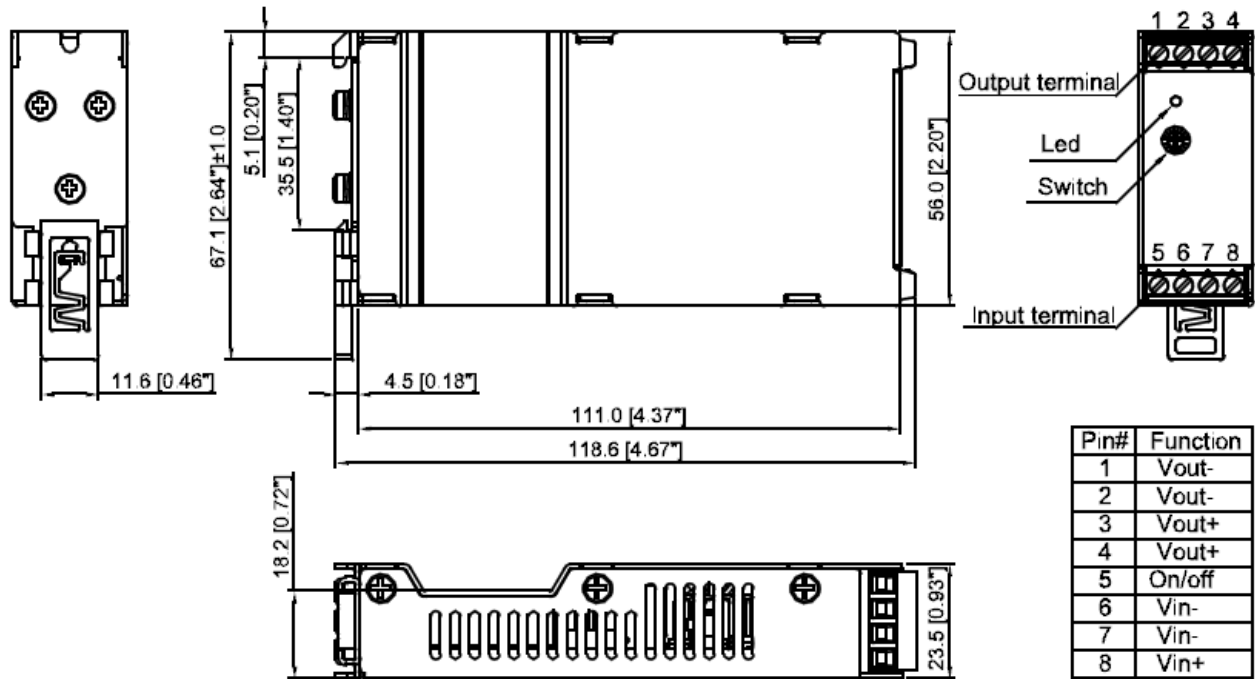

Product Size: 118.6*67.1*23.5(4.67**2.64**0.93")

Case material: Aluminum alloy

Baseplate material: Aluminum alloy

Input terminal: M3 Screw Terminal

Input wire range: 28~16 AWG

Output Terminal: M3 Screw Terminal

Output wire range: 28~16 AWG

Weight: 135 grams

- All dimensions in mm (inches)
- Tolerance: X.X±0.5 (X.XX±0.02)
X.XX±0.25 (X.XXX±0.010)

PART NUMBERING SYSTEM

PM	24	S	120	05	P	A	F	A
Form factor	Input voltage	Number of output	Output voltage	Output current	On/off logic	Terminal Type	RoHS	Option Code
PM - Panel Mount	24 - 9~36V	S - Single	120 - 12V	05 - 5A	N - Negative P - Positive	A - Screw terminal	F - RoHS 6/6 (Lead Free)	A - With EMI filter

DR	24	S	120	05	P	A	F	A
Form factor	Input voltage	Number of output	Output voltage	Output current	On/off logic	Terminal Type	RoHS	Option Code
DR - DIN-rail Mount	24 - 9~36V	S - Single	120 - 12V	05 - 5A	N - Negative P - Positive	A - Screw terminal	F - RoHS 6/6 (Lead Free)	A - With EMI filter

CONTACT: www.deltaww.com/dcdc

Email: dcdc@deltaww.com

USA:

Telephone:
East Coast: 978-656-3993
West Coast: 510-668-5100
Fax: (978) 656 3964

Europe:

Phone: +31-20-655-0967
Fax: +31-20-655-0999

Asia & the rest of world:

Telephone: +886 3 4526107
ext 6220~6226
Fax: +886 3 4513485

WARRANTY

Delta offers a two (2) years limited warranty. Complete warranty information is listed on our web site or is available upon request from Delta.

Information furnished by Delta is believed to be accurate and reliable. However, no responsibility is assumed by Delta for its use, nor for any infringements of patents or other rights of third parties, which may result from its use. No license is granted by implication or otherwise under any patent or patent rights of Delta. Delta reserves the right to revise these specifications at any time, without notice.