



PRODUCT DATASHEET

Laura series

last update 25/2/2013

DETAILS

Product Number	CA13269_LAURA-SS-WAS
Family	Laura
Type	Assembly
Color	white
Diameter	21,6 x 21,6 mm
Height	13,1 mm
Style	square
Optic Material	PMMA
Holder Material	
Fastening	tape
Status	production ready
ROHS Compliant	Yes
Date Updated	25/02/2013



OPTICAL PROPERTIES

LED	Viewing Angle	Light Beam	Efficiency	cd/lm	Connector
XP-E	Asymmetric deg	Asymmetric	92 %	11.600	-
LUXEON Q	asymmetric deg	Asymmetric	91 %	10.300	-

D

C

B

A

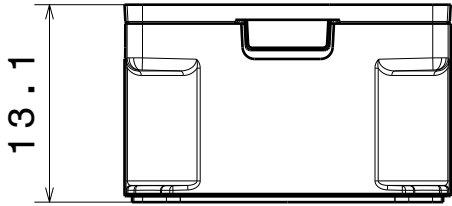

Front View

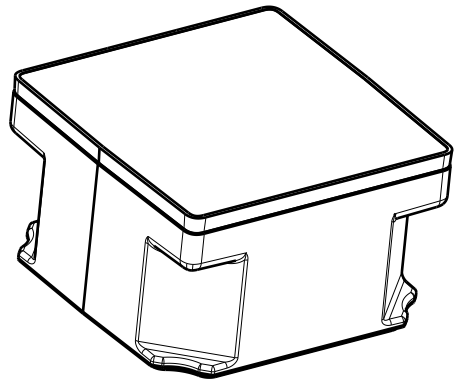

Isometric view

Oval Beam Direction

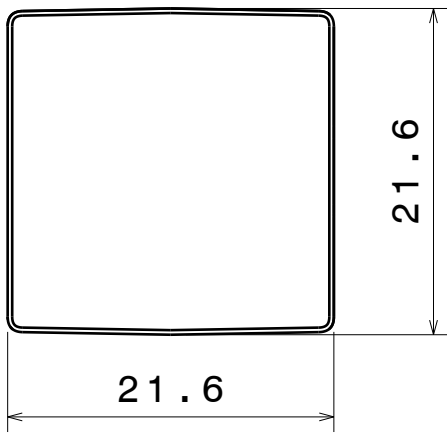

Top view

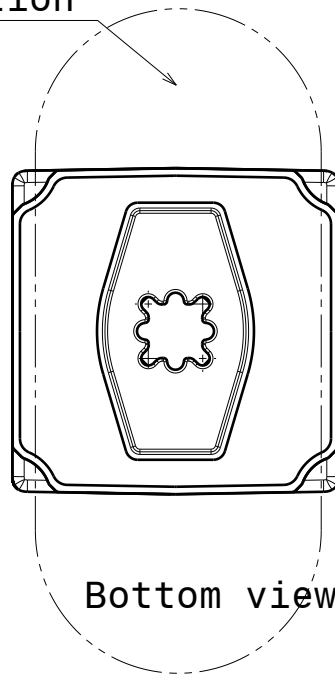

Bottom view

This drawing is our property.
It can't be reproduced
or communicated without
our written agreement.



Ledil Oy
Salorankatu 10
FIN 24240 SALO
Finland

DRAWING TITLE Mechanical Drawing

DRAWN BY
ks

DATE
08.11.2012

LAURA-XP

CHECKED BY
as

DATE
-

SIZE A4

PART NUMBER

REV
001

DESIGNED BY
-

DATE
-

SCALE 2:1

WEIGHT

SHEET 1/1

D

A

4

4

3

3

2

2

1

1

Luminaire: Ledil Oy CA13269_LAURA-SS-WAS_(XP-E) Efficiency=92%
Lamps: 1 x Cree XP-E 70lm @ 250mA

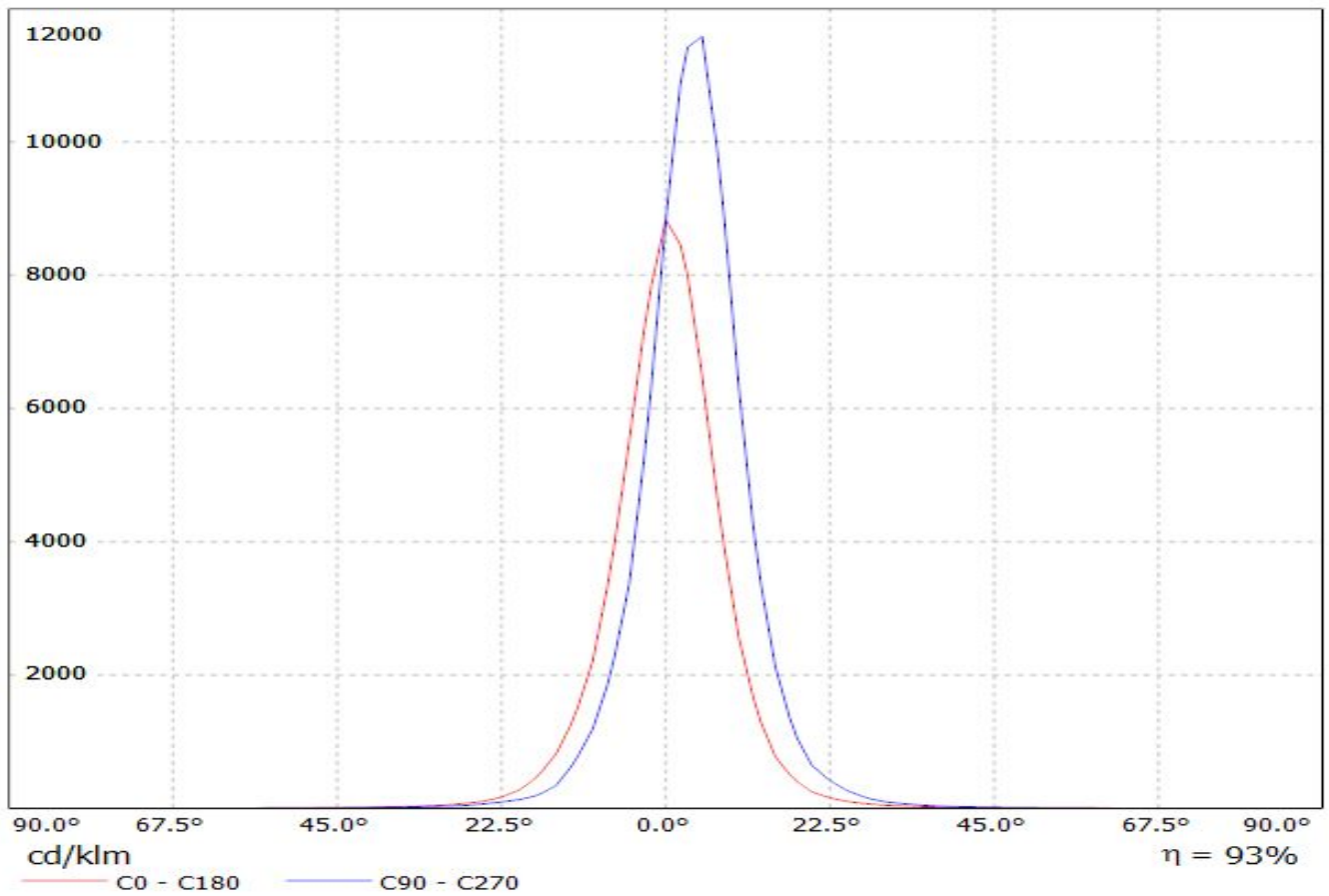

Luminaire: LEDiL Oy CA13269_LAURA-SS-WAS_(LUXEON_Q) Eff: 91%
Lamps: 1 x LUXEON_Q_(LHQ-3080)_79.56lm@250mA_P=0.753249W_I=249.9mA

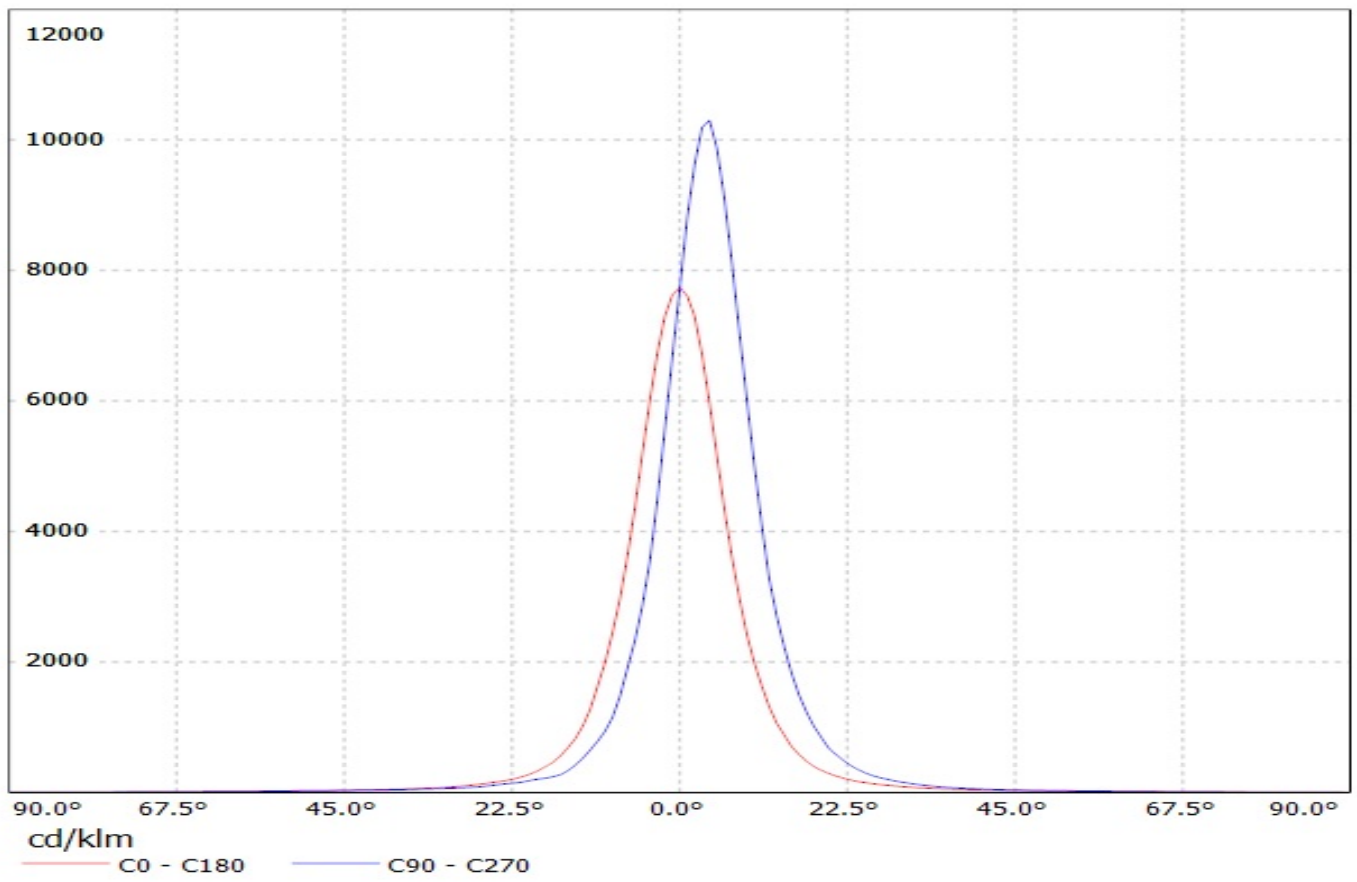

Luminaire: Ledil Oy CA13269_LAURA-SS-WAS_(XP-E) Efficiency=92%
Lamps: 1 x Cree XP-E 70lm @ 250mA

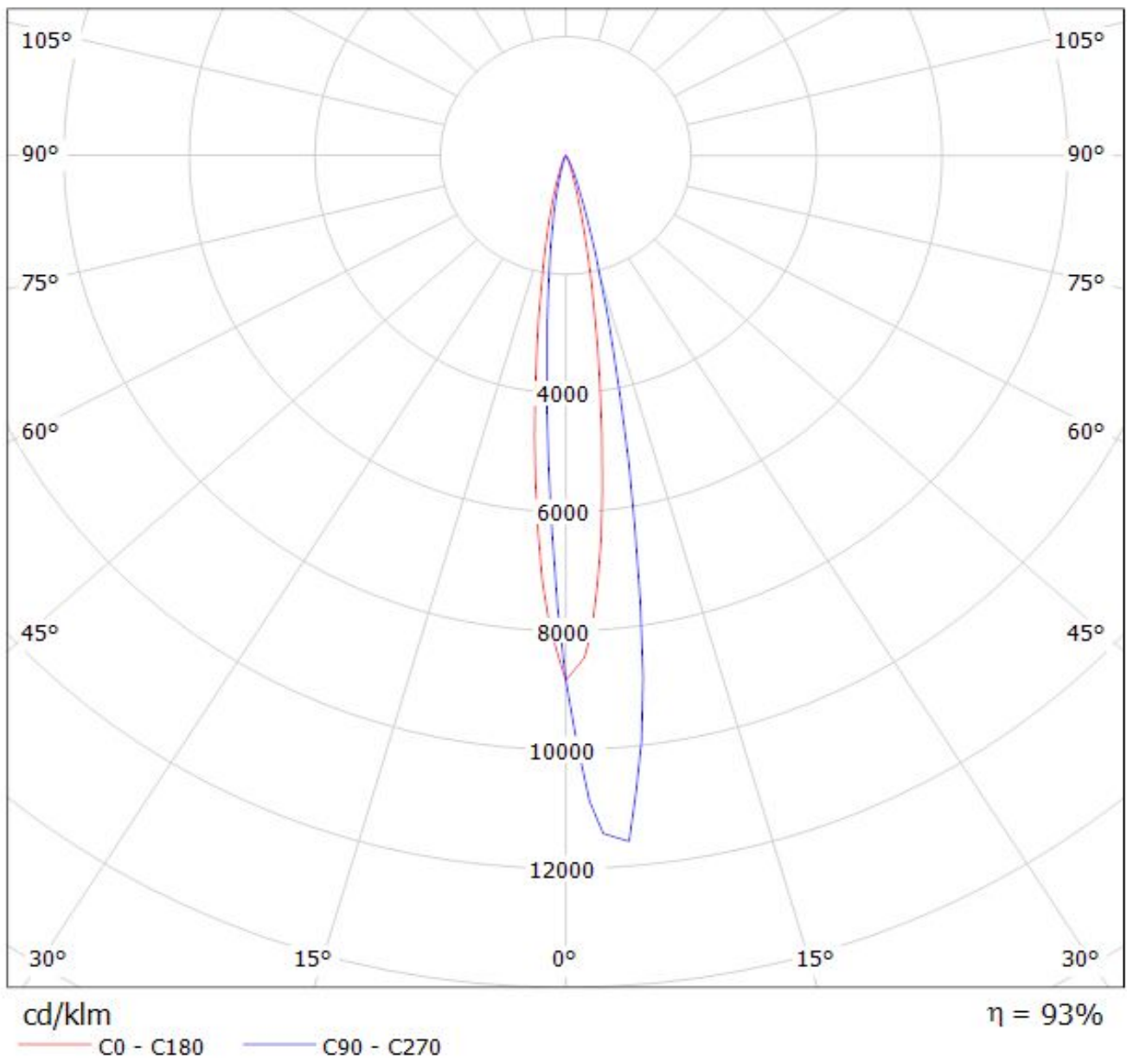

Luminaire: LEDiL Oy CA13269_LAURA-SS-WAS_(LUXEON_Q) Eff: 91%
Lamps: 1 x LUXEON_Q_(LHQ-3080)_79.56lm@250mA_P=0.753249W_I=249.9mA

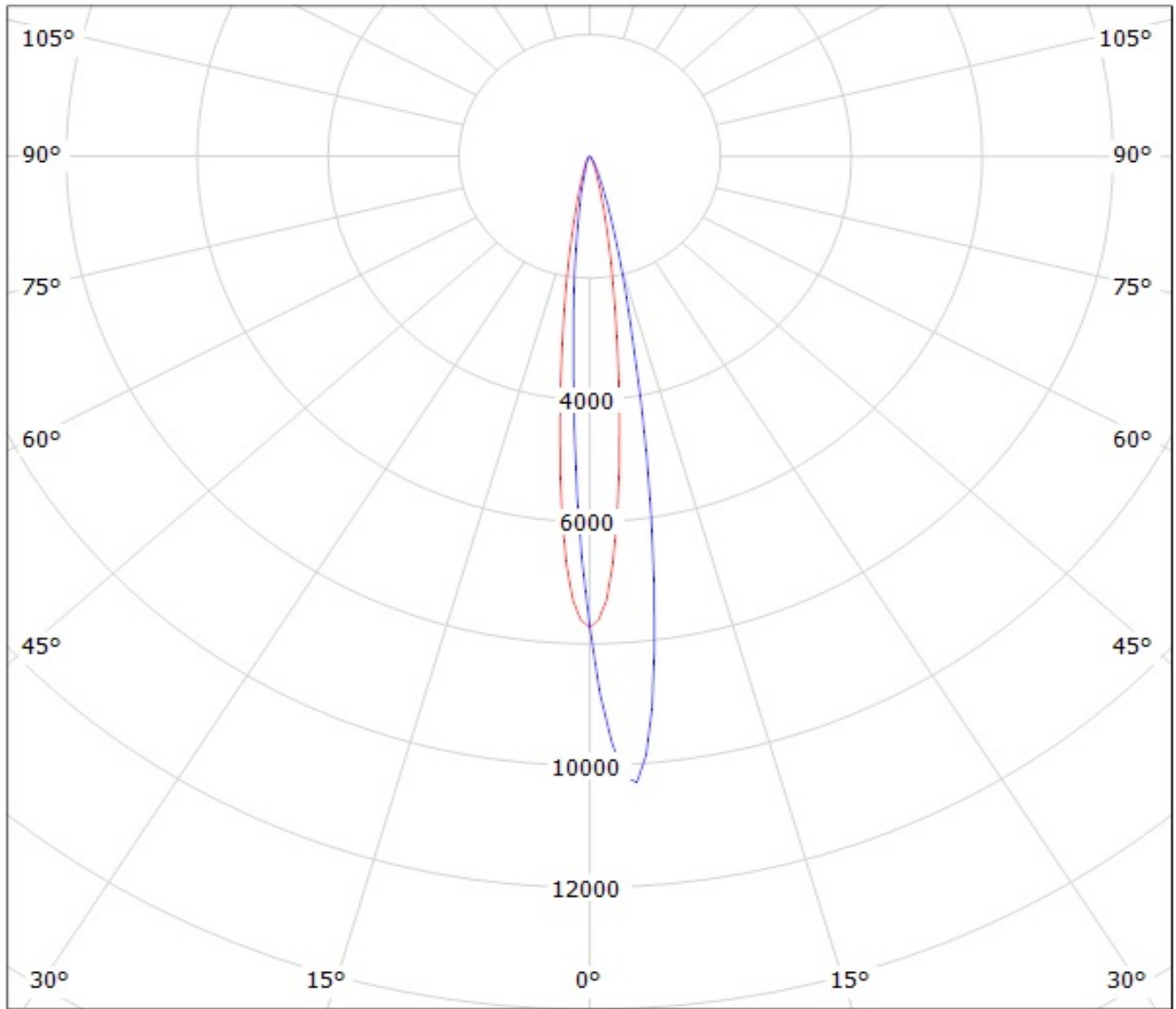

cd/klm

— C0 - C180

— C90 - C270

NOTE: The typical divergence will be changed by different color, chip size and chip position tolerance. The typical total divergence is the full angle measured where the luminous intensity is half of the peak value.