

IB IL DC AR 48/10A (-2MBD-PAC)

Inline Servo Amplifier for DC Motors With Brushgears

AUTOMATION

Data Sheet
6455_en_02

© PHOENIX CONTACT - 12/2007

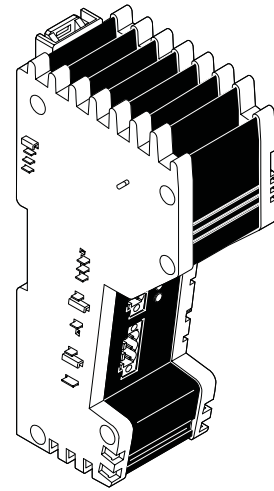

1 Description

The Inline servo amplifier is designed for use within an Inline station. It is a universal speed or torque controller with a power output module for permanently excited DC motors with brushgears with a power consumption of up to 450 W.

The Inline servo amplifier has a 4 quadrant function, i.e., it supplies power back to the power supply unit when the brake function is used.

1.1 Features

- Diagnostic and status indicators
- Can be used as a torque controller or speed controller
- 4 quadrant function
- External brake chopper
- Short-circuit-proof motor output

1.2 Applications

The Inline servo amplifier is used under the following conditions:

- Permanently excited DC motors with brushgears
- Nominal voltages of 12 V to 48 V
- Power consumption of up to 450 W
- Motor current of up to 10 A



This data sheet is only valid in association with the IL SYS INST UM E user manual or the Inline system manual for your bus system, as well as the user manual for the Inline servo amplifier UM EN IB IL DC AR 48/10A.



Make sure you always use the latest documentation.
It can be downloaded at www.download.phoenixcontact.com.
A conversion table is available on the Internet at
www.download.phoenixcontact.com/general/7000_en_00.pdf.



This data sheet is valid for all products listed on the following page:

2 Ordering Data

Products

Description	Type	Order No.	Pcs./Pck.
Inline servo amplifier for DC motors with brushgears; complete with accessories (connectors); transmission speed of 500 kbps	IB IL DC AR 48/10A	2819286	1
Inline servo amplifier for DC motors with brushgears; complete with accessories (connectors); transmission speed of 2 Mbps	IB IL DC AR 48/10A-2MBD-PAC	2897677	1

Documentation

Description	Type	Order No.	Pcs./Pck.
"Inline Servo Amplifier for DC Motors With Brushgears" user manual	UM EN IB IL DC AR 48/10A	2699192	1
"Automation Terminals of the Inline Product Range" user manual	IL SYS INST UM E	2698737	1
"Configuring and Installing the INTERBUS Inline Product Range" user manual	IB IL SYS PRO UM E	2743048	1

3 Technical Data

3.1 Housing Dimensions

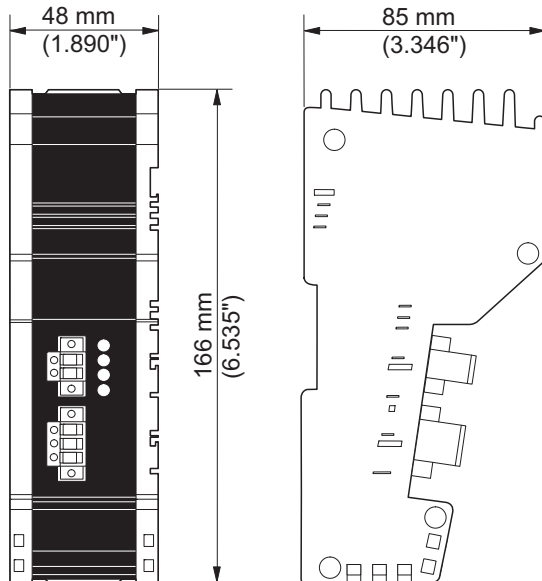

6455A031

General Data

Housing dimensions (width x height x depth)	48 mm x 85 mm x 166 mm
Housing material	PA 6.6; black, anodized aluminum
Heatsink material	Aluminum
Weight (typical)	460 g
Permissible temperature (operation)	-25°C to +55°C
Permissible temperature (storage/transport)	-25°C to +85°C

General Data (Continued)

Permissible humidity (storage/transport with unused interfaces (standard packaging)) 75% permanent, 85% occasionally



For a short period, slight condensation may appear on the outside of the housing if, for example, the module is brought into a closed room from a vehicle.

Permissible air pressure (operation)	80 kPa to 106 kPa (up to 2000 m above sea level)
Permissible air pressure (storage/transport)	70 kPa to 106 kPa (up to 3000 m above sea level)
Permissible humidity (operation/storage/transport)	10% to 95%, according to EN 61131-2
Degree of protection	IP20 according to IEC 60529
Protection class	Class 3 according to VDE 0106, IEC 60536

Transmission Speed

IB IL DC AR 48/10A	500 kbps
IB IL DC AR 48/10A-2MBD-PAC	2 Mbps

Mechanical Requirements

Vibration test; sinusoidal vibrations according to IEC 60068-2-6, EN 60068-2-6	2g load, 2 hours in each space direction
Shock test; according to IEC 60068-2-27, EN 60068-2-27	25g for 1 ms, three shocks in each space direction
Free fall according to IEC 60068-2-32	1 m

Power Supply

Status indicators	US LED
Connection method	2-pos. COMBICON connector
Supply voltage U_S	12 V DC to 48 V DC $\pm 15\%$
Supply current	0 A to 10 A
Surge voltage shutdown	$U_S > 60$ V DC

Outputs

Number	1
Connection	1 permanently excited DC motor with brushgears
Connection method	3-pos. COMBICON connector with shield connection clamp
Output voltage	\pm Supply voltage U_S , maximum Mean value 92% of U_S , maximum
Motor cable	2-wire, shielded
Continuous current	10 A, maximum
Starting current	10 A, maximum
Motor current limiting	0 A to 10 A (can be set via bus)
Maximum motor voltage	± 65 V DC
Function	4 quadrant servo controller
Braking	Energy fed back to the power supply unit (brake chopper may be required)
Minimum motor inductance	200 μ H at $U_S = 48$ V DC 100 μ H at $U_S = 24$ V DC

Cycle Time of Internal Digital Controllers

Speed controller	1 ms
Torque/current controller	250 μ s

Electrical Isolation

Logic U_L /I/O/motor	500 V AC test voltage
------------------------	-----------------------

Pulse Width Modulation (PWM)

Clock frequency	20 kHz
-----------------	--------

Interfaces	500 kbps	2 Mbps
Local bus	Inline potential distributor	Inline potential distributor
Communications power U_L	7.5 V DC (via potential distributor)	7.5 V DC (via potential distributor)
Current consumption at U_L	45 mA, typical	60 mA, typical
Main voltage U_M	24 V DC (via potential distributor)	24 V DC (via potential distributor)
Current consumption at U_M	65 mA, typical	65 mA, typical

Conformance With EMC Directive 89/336/EEC and 2004/108/EC



Conformance is only ensured if the shielded motor cable is connected to the FE terminal and the module is connected to functional earth ground via the DIN rail.

Noise Immunity Test According to EN 61000-6-2

Electrostatic discharge (ESD)	EN 61000-4-2 IEC 61000-4-2	Criterion B 6 kV contact discharge 8 kV air discharge
Fast transients (burst)	EN 61000-4-4 IEC 61000-4-4	Criterion B Supply lines: 2 kV Signal/data lines: 2 kV Criterion A Interfaces: 1 kV
Conducted interference	EN 61000-4-6 IEC 61000-4-6	Criterion A, test voltage 10 V

Noise Emission Test According to EN 61000-6-4

Noise emission of housing	EN 55011	Class A
---------------------------	----------	---------

Approvals

For the latest approvals, please visit www.download.phoenixcontact.com or www.eshop.phoenixcontact.com.

4 Typical Application of the Inline Servo Amplifier

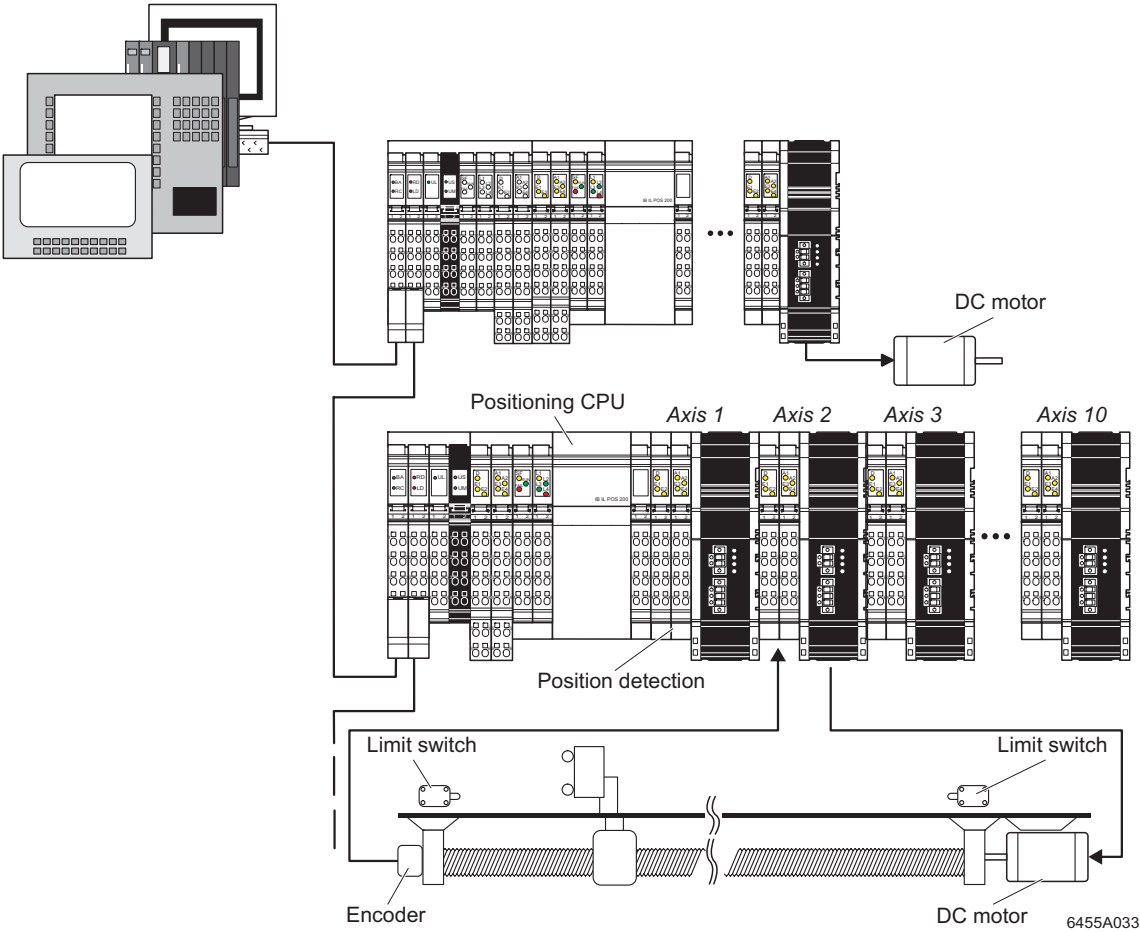

Figure 1 Typical application of the Inline servo amplifier

5 Structure of the Module

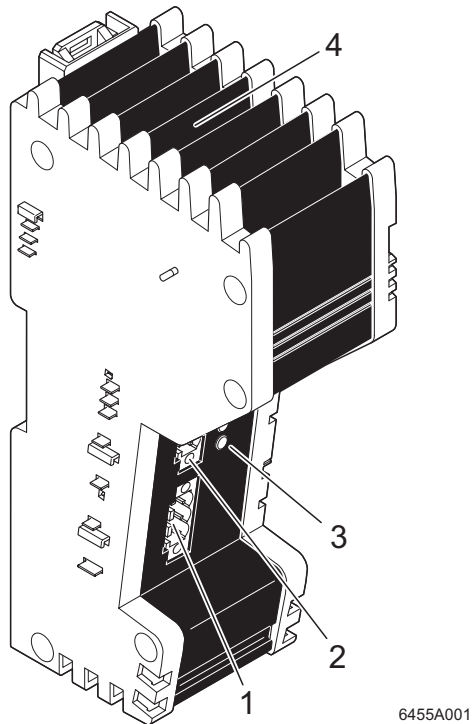
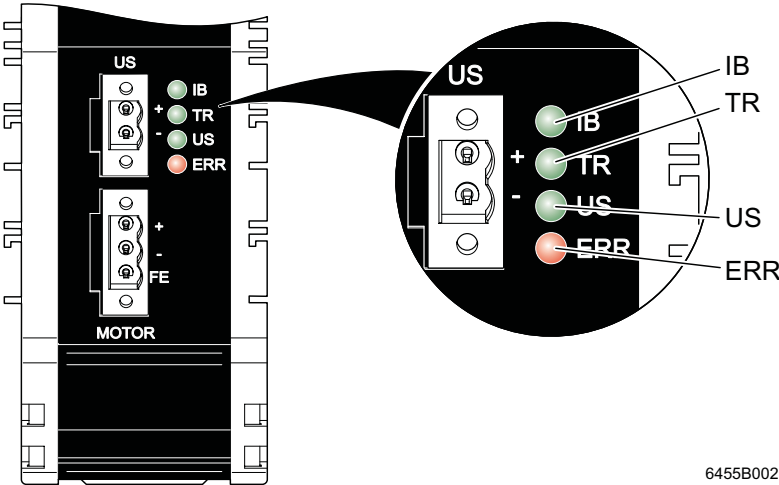

Figure 2 Structure of the Inline servo amplifier

The Inline servo amplifier consists of the following components:

- 1 Motor connection
- 2 Power supply connection
- 3 Diagnostic and status indicators
- 4 Heatsink

6 Local Diagnostic and Status Indicators



6455B002

Figure 3 Local diagnostic and status indicators

Des.	Color	Meaning
IB	Green LED	Diagnostics
	ON:	Bus active
	Flashing:	
	0.5 Hz:	Communications power present, bus not active
	2 Hz:	Communications power present, bus active, I/O error
	4 Hz:	Communications power present, terminal before the flashing module failed, terminal after the flashing module not part of the configuration frame
OFF:	Communications power not present, bus not active	
TR	Green LED	PCP active
	ON:	PCP messages being transmitted to the Inline servo amplifier
	OFF:	No transmission of PCP messages
US	Green LED	Supply voltage of the power section
	ON:	Supply voltage for the output module is more than 75% of the nominal voltage of the power supply
	OFF:	Supply voltage for the output module is less than 75% of the nominal voltage of the power supply
ERR	Red LED	Error
	ON:	An error has occurred (corresponds to bit 3 in the status word). The cause of the error can be read in the "ErrorCode" parameter (index 603F _{hex}).
	OFF:	No error

7 Terminal Point Assignment

7.1 Power Supply Connection

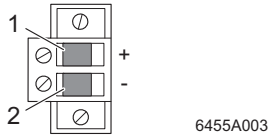

Figure 4 Terminal point assignment of the power supply connection (US)

Terminal Point	Assignment
1	$U_S +$
2	$U_S -$

7.2 Motor Connection

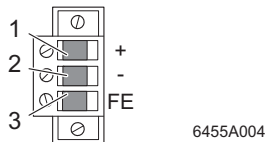

Figure 5 Terminal point assignment of the motor connection (MOTOR)

Terminal Point	Assignment
1	Motor +
2	Motor -
3	Functional earth ground (FE)

8 Function Description

The Inline servo amplifier is designed as an Inline terminal. It can thus be easily operated in any control system and can be used to create a distributed positioning control system simply by mounting Inline positioning terminals side by side (e.g., positioning CPUs, position detection terminals, and other digital and analog output terminals).

Optical status and diagnostic indicators enable quick local error diagnostics.

The following operating modes are possible:

- Speed control without IxR compensation (voltage control)
- Speed control with IxR compensation
- Torque control (current control)

The Inline servo amplifier autonomously controls the speed or the torque of the connected motor to the value specified

as the desired speed/torque via Inline in the form of process data (4 quadrant mode).

A special feature of the Inline servo amplifier is that it can be used to create simple speed-controlled drives using cost-effective DC motors with brushgears, without the need for a rotary encoder system (e.g., on the motor shaft).

This method relies on a particular aspect of the behavior of DC motors: their speed changes in proportion to the supply voltage. In this way the speed can be indirectly controlled via the motor voltage.

In addition, the Inline servo amplifier uses an IxR controller, which compensates for speed variations caused by the changing load.

Operation, setting the operating mode, and parameterization are compatible with the "DRIVECOM profile 22" protocol.

The Inline servo amplifier has safety equipment, which provides protection against:

- Overcurrent
- Surge voltage and undervoltage
- Overtemperature
- Short circuit between motor cables
- Short circuit to the power supply

The Inline servo amplifier is based on digital controllers. Its task is to provide current and voltage values, which can be used to directly operate DC motors with brushgears.

Since Inline jumpering cannot supply these high currents, the Inline servo amplifier must be supplied externally with 12 V to 48 V and 0 A to 10 A.

The level of the current and voltage values depends on the various functions that the Inline servo amplifier carries out in the individual operating modes.



For a description of the operating modes and the parameters, please refer to the UM EN IB IL DC AR 48/10A user manual.

9 Programming Data/Configuration Data

9.1 Local Bus

ID code	C3 _{hex} (195 _{dec})
Length code	02 _{hex} (02 _{dec})
Process data channel	32 bits
Input address area	2 words
Output address area	2 words
Parameter channel (PCP)	1 word
Register length (bus)	3 words

9.2 Other Bus Systems



For the programming data/configuration data of other bus systems, please refer to the corresponding electronic device data sheet (e.g., GSD, EDS) at www.phoenixcontact.com.