

EZO-pH™

Embedded pH Circuit

ISO 10523 Compliant

(determination of pH)

Reads	pH
Range	.001 – 14.000
Resolution	.001
Accuracy	+/- 0.002
pH reading time	800ms
Supported probes	Any type & brand
Calibration	1, 2, 3 point
Temp compensation	Yes
Data protocol	UART & I²C
Default I ² C address	99 (0x63)
Operating voltage	3.3V – 5V
Data format	ASCII

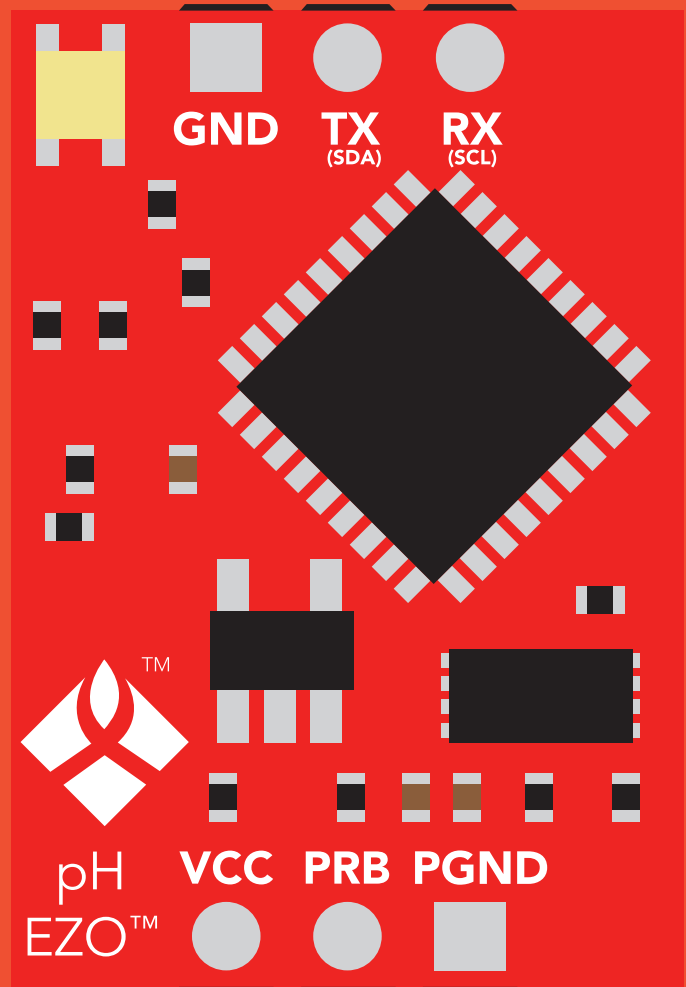

PATENT PROTECTED

The EZO™ pH Circuit has all the features of this bench top meter.

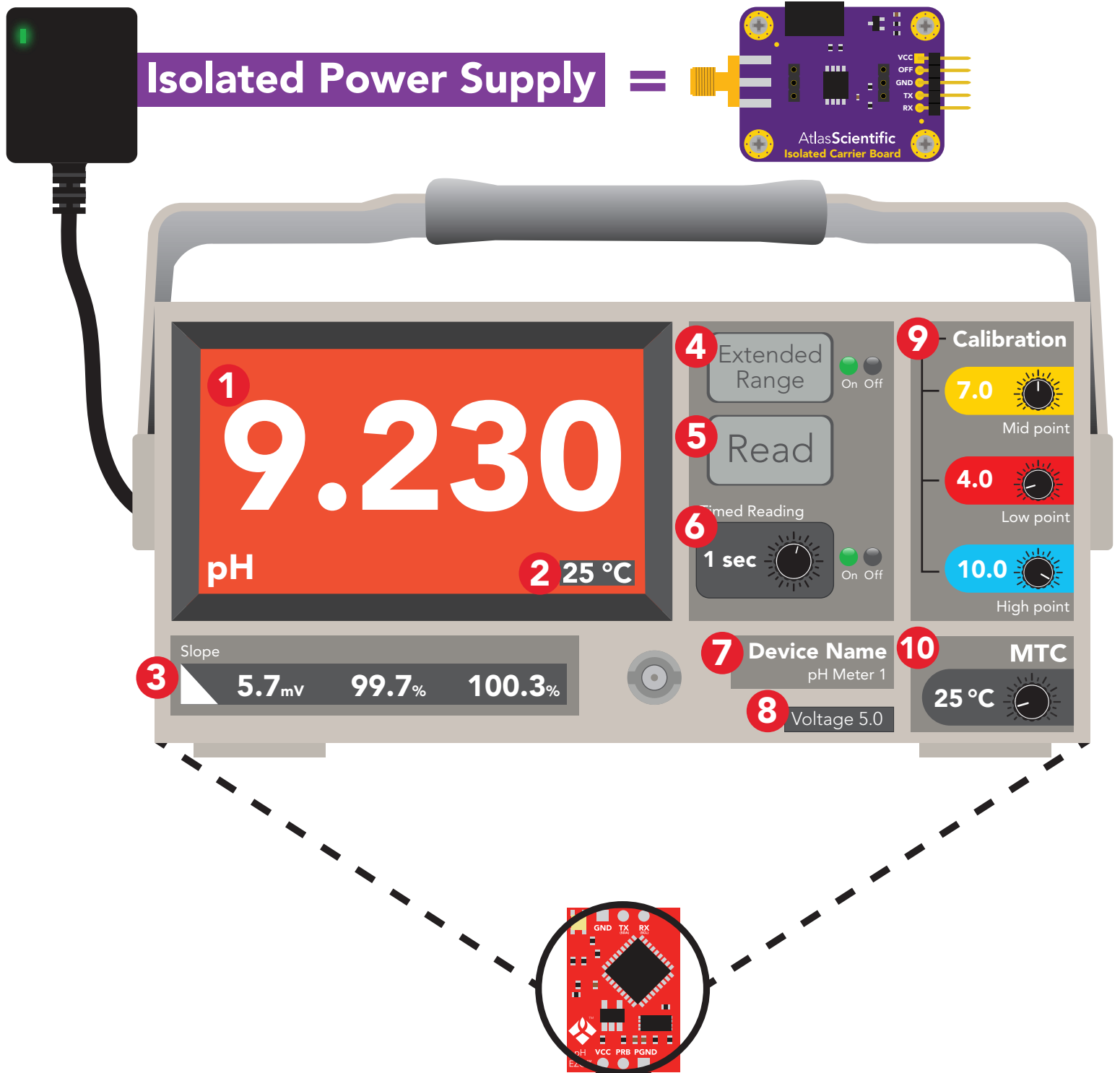

- 1 Three decimal pH reading
- 2 Temperature used for reading
- 3 Calibration slope
- 4 Extended range capability
- 5 Immediate reading

- 6 Timed readings
- 7 Set device name
- 8 Voltage usage
- 9 Multi point calibration
- 10 Manual temperature compensation

The EZO™ pH Circuit is compatible with any brand of pH probe.

✓ Available data protocols

UART

Default

I²C

X Unavailable data protocols

SPI

Analog

RS-485

Mod Bus

4–20mA

STOP



SOLDERING THIS DEVICE VOIDS YOUR WARRANTY.

Are there specific soldering instructions? Yes, see page 71.

Can you make a warranty claim after soldering? No.

If you have not used this product before; Observe how a properly working sensor behaves *BEFORE* embedding it into your PCB.

Get this device working using one of these methods first.

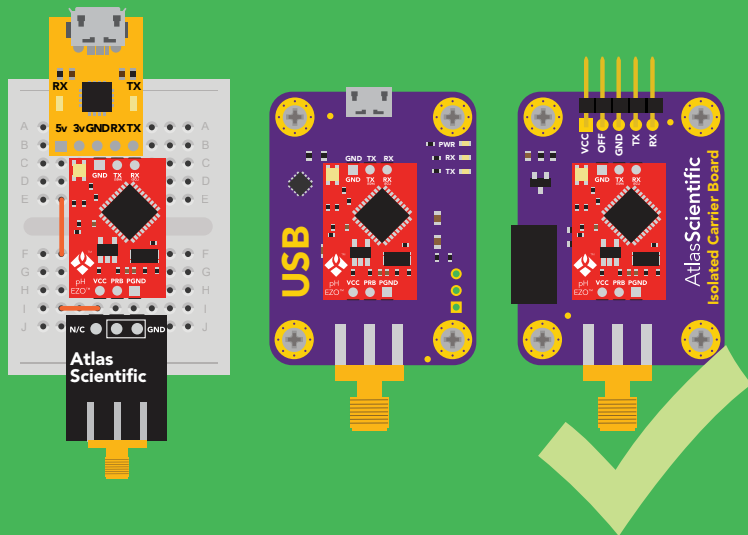

Do not embed before you have experience with this sensor.

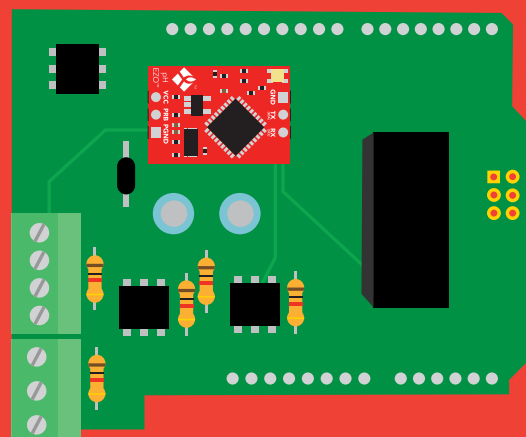

Table of contents

Available data protocols	3	Correct wiring	9
Circuit dimensions	6	Default state	12
Power consumption	6	Circuit footprint	73
Absolute max ratings	6	Datasheet change log	74
Electrical isolation	7	Warranty	78

Calibration theory	63
Understanding pH Slope	68

UART

UART mode	13
LED color definition	14
Receiving data from device	15
Sending commands to device	16
UART quick command page	17
LED control	18
Find	19
Continuous reading mode	20
Single reading mode	21
Calibration	22
Export calibration	23
Import calibration	24
Slope	25
Extended pH scale	26
Temperature compensation	27
Naming device	28
Device information	29
Response codes	30
Reading device status	31
Sleep mode/low power	32
Change baud rate	33
Protocol lock	34
Factory reset	35
Change to I ² C mode	36
Manual switching to I ² C	37

I²C

I ² C mode	39
Sending commands	40
Requesting data	41
Response codes	42
LED color definition	43
I²C quick command page	44
LED control	45
Find	46
Taking reading	47
Calibration	48
Export calibration	49
Import calibration	50
Slope	51
Extended pH scale	52
Temperature compensation	53
Naming device	54
Device information	55
Reading device status	56
Sleep mode/low power	57
Protocol lock	58
I ² C address change	59
Factory reset	60
Change to UART mode	61
Manual switching to UART	62

EZO™ circuit dimensions

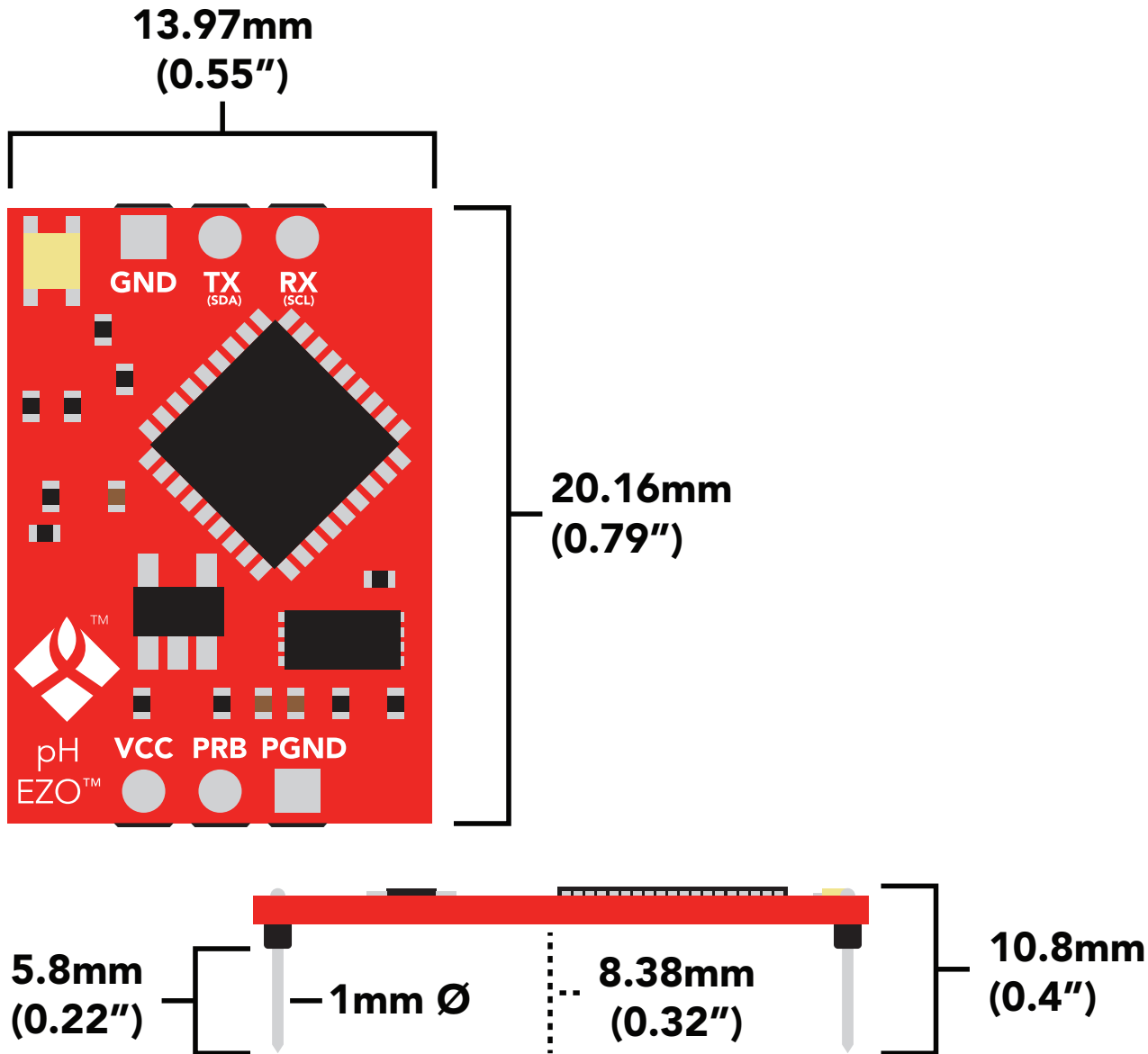

Power consumption

	LED	MAX	STANDBY	SLEEP
5V	ON	18.3 mA	16 mA	1.16 mA
	OFF	13.8 mA	13.8 mA	
3.3V	ON	14.5 mA	13.9 mA	0.995 mA
	OFF	13.3 mA	13.3 mA	

Absolute max ratings

Parameter	MIN	TYP	MAX
Storage temperature (EZO™ pH)	-65 °C		125 °C
Operational temperature (EZO™ pH)	-40 °C	25 °C	85 °C
VCC	3.3V	5V	5.5V

Electrical isolation

The Atlas Scientific EZO™ pH circuit is a very sensitive device. This sensitivity is what gives the pH circuit its accuracy. It also means that the pH circuit can read micro-voltages bleeding into the water from unnatural sources such as pumps, solenoid valves, or other probes/sensors.

When electrical noise interferes with the pH readings, it is common to see rapidly fluctuating readings or readings that are pinned to 14 or 0. To verify that electrical noise is causing inaccurate readings, place the pH probe in a cup of water by itself. The readings should stabilize quickly, confirming that electrical noise was the issue.

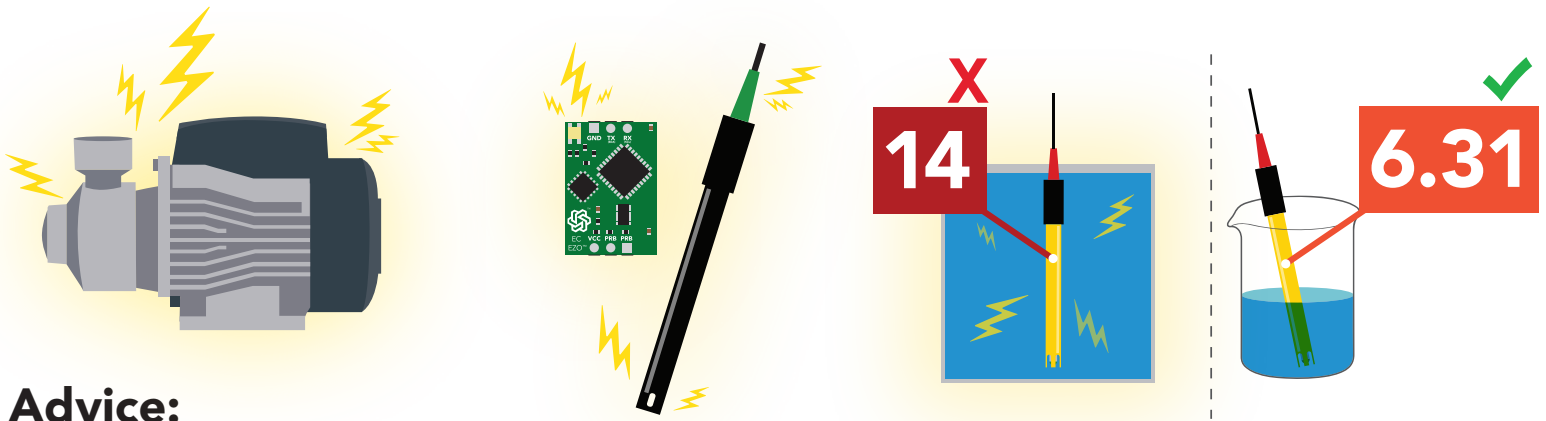

Advice:

1. When reading pH along with other sensors, electrical isolation is strongly recommended.
2. Never build a commercial product without electrical isolation.

Atlas Scientific offers several different electrical isolation products that can be used in your design. Select the electrical isolation product that works best for your design.

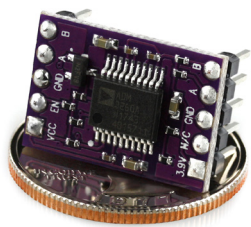

Basic EZO™
Inline Voltage Isolator

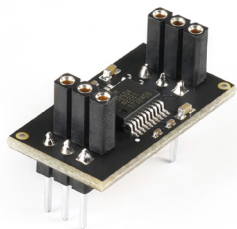

Vertical Isolator

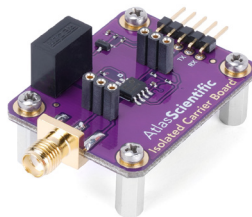

Electrically Isolated
EZO™ Carrier Board

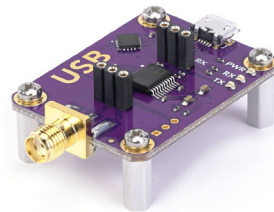

Gen 2 Electrically Isolated
USB EZO™ Carrier Board

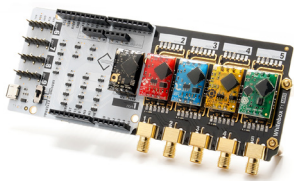

Whitebox T1

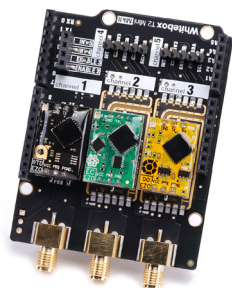

Whitebox T3

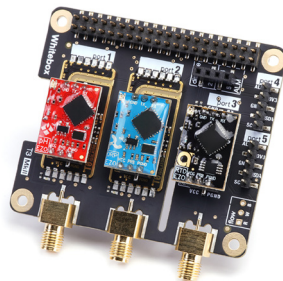

Whitebox T3



Electrically Isolated EZO™
Carrier Board (old style)

For various reasons, you may need to build your own electrical isolator. Because electrical isolation is so important, we have published our isolation schematic for anyone to use.

This isolation schematic is based on the ADM3260, which can output up to 150 mW of isolated power. PCB layout requires special attention for EMI/EMC and RF Control. Having good ground planes and keeping the capacitors as close to the chip as possible are crucial for proper performance.

The two data channels have a 4.7kΩ pull-up resistor on both the isolated and non-isolated lines (R1, R2, R3, and R4). The output voltage is set using a voltage divider (R5, R6, and R7). This produces a voltage of 3.9V regardless of your input voltage.

Isolated ground is different from non-isolated ground, these two lines should not be connected together.

VCC = 3.0v – 5.5v

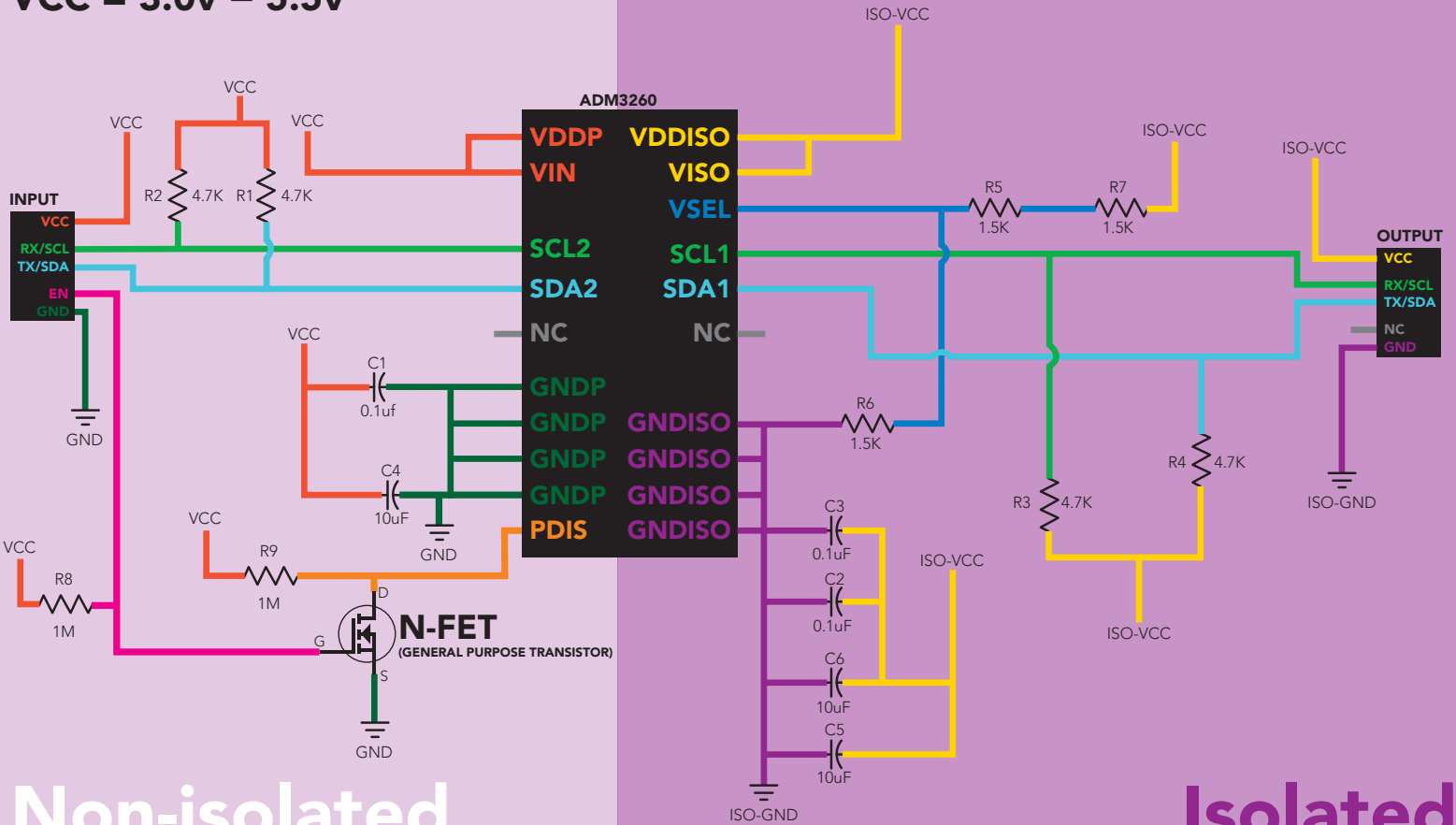

✓ Correct wiring

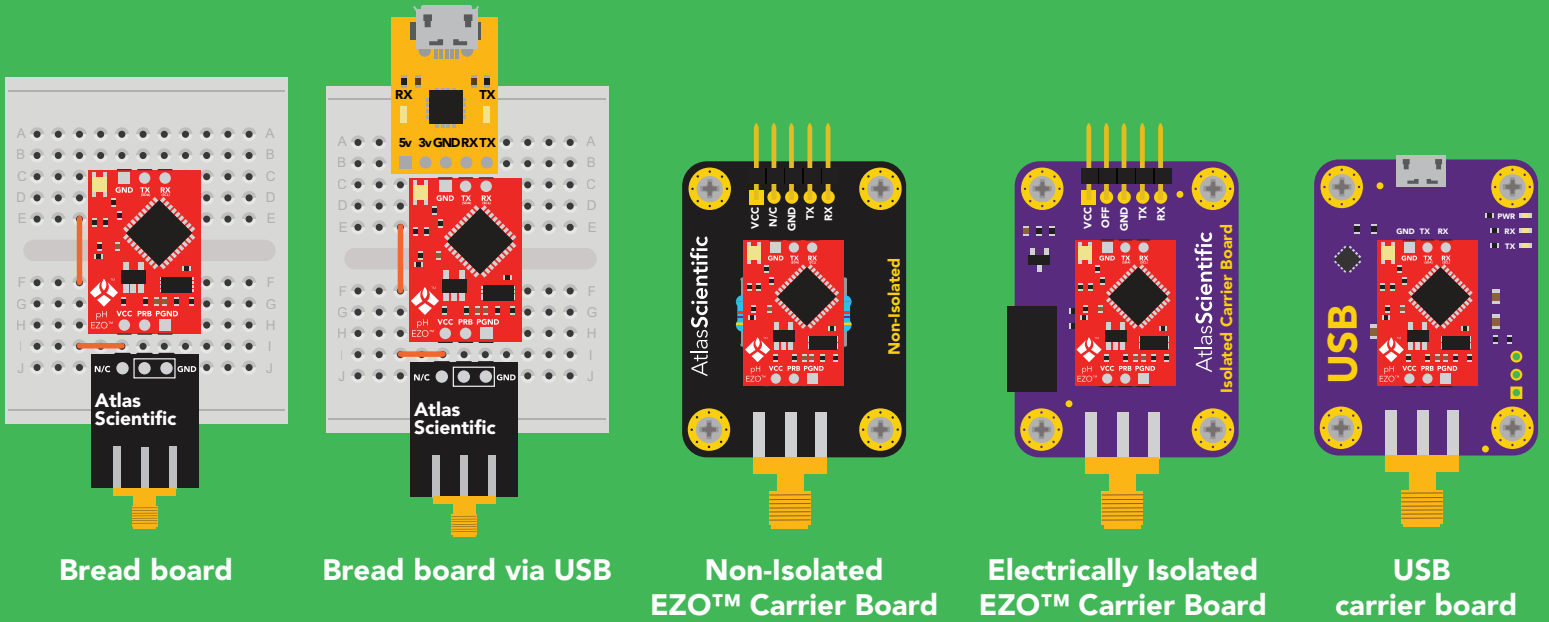

✗ Incorrect wiring

Extended leads Sloppy setup Perfboards or Protoboards *Embedded into your device

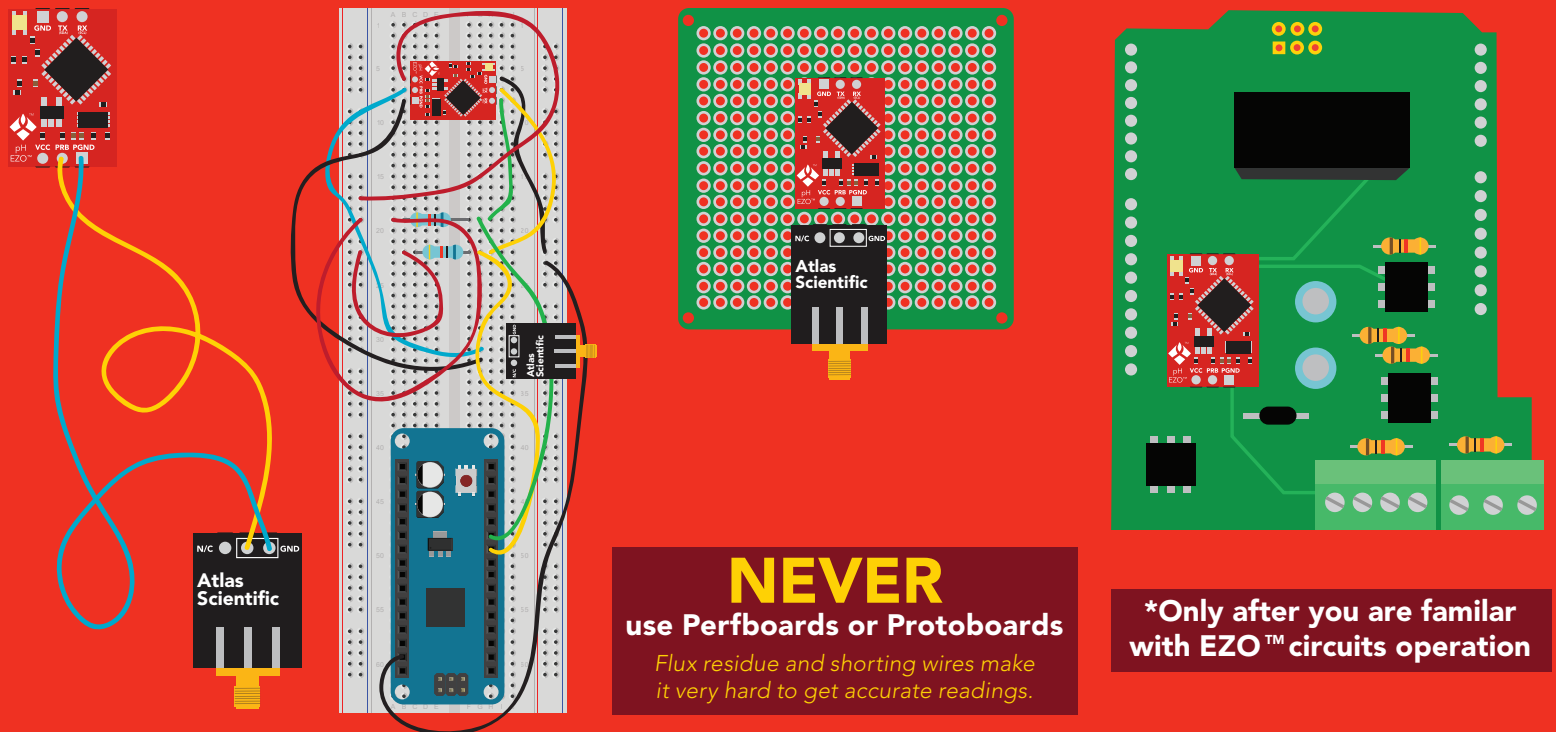

**DO NOT MAKE YOUR OWN
UNSHIELDED CABLES!**

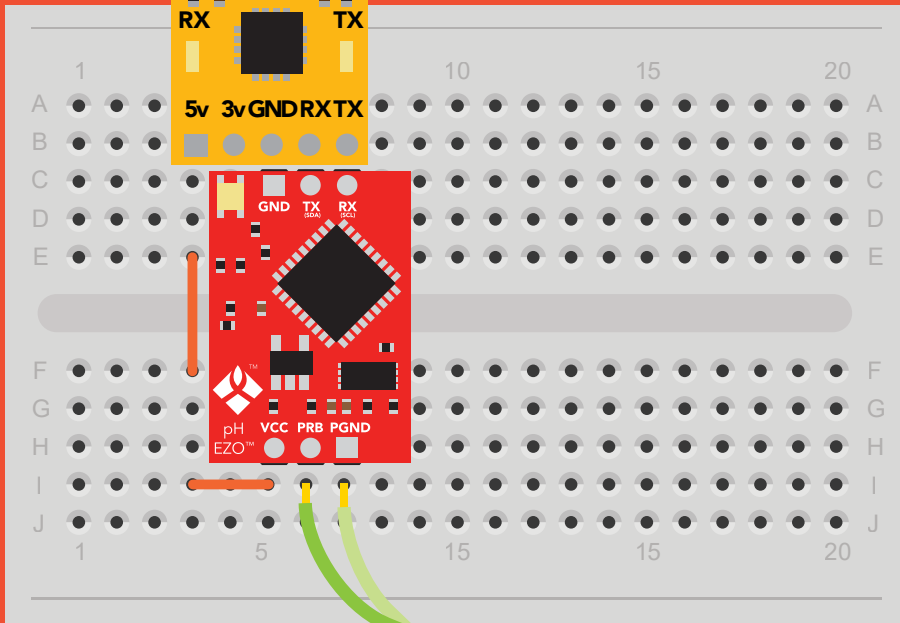

ONLY USE SHIELDED CABLES.

Default state

UART mode

Baud 9,600

Readings continuous

Units pH

Speed 1 reading per second

LED on

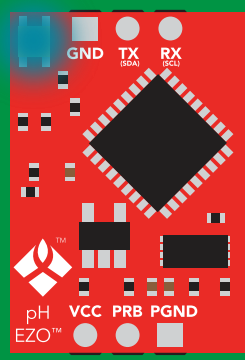
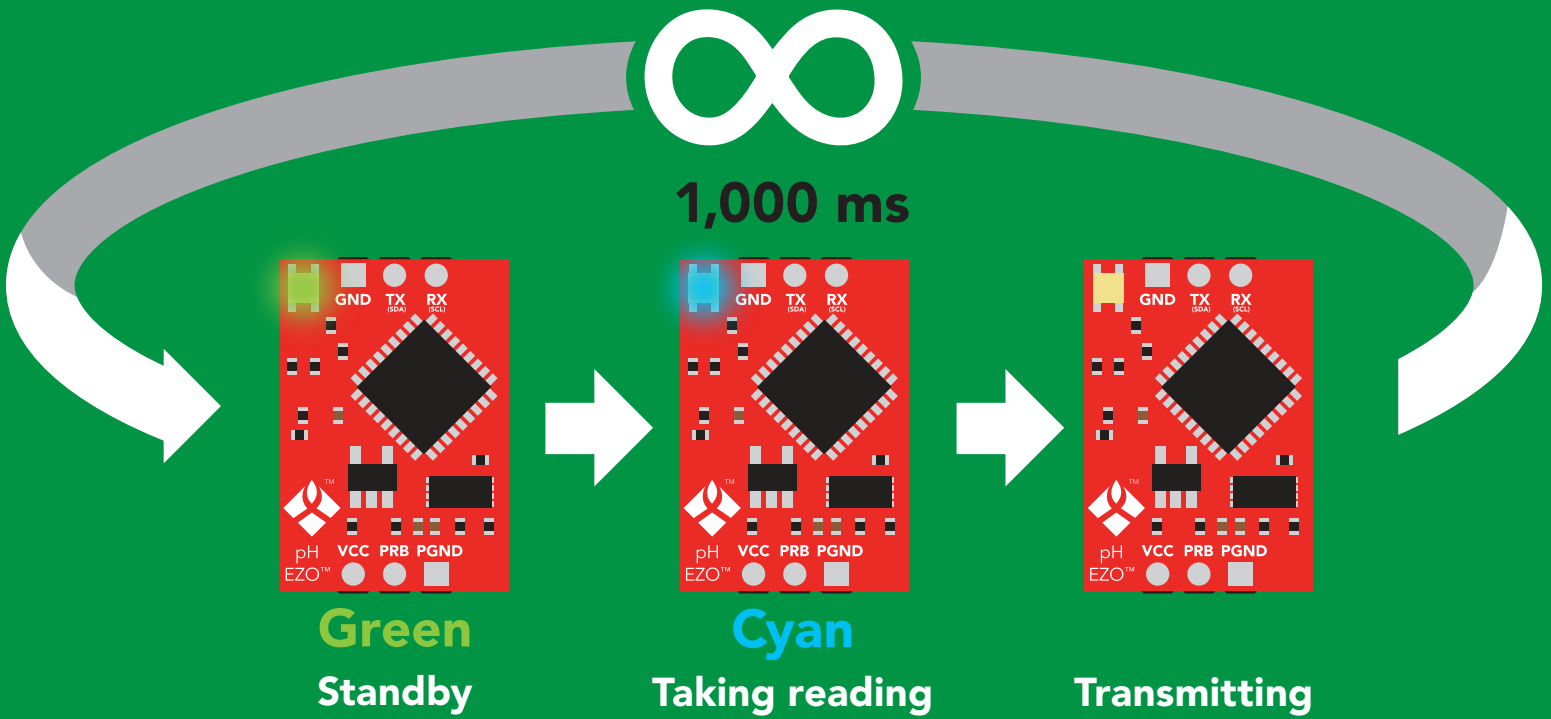

Solid Blue LED
in I²C mode
Not UART ready

UART mode

8 data bits
1 stop bit

no parity
no flow control

Baud 300
1,200
2,400
9,600 default
19,200
38,400
57,600
115,200

RX
Data in



TX
Data out



Vcc 3.3V – 5.5V



0V VCC 0V

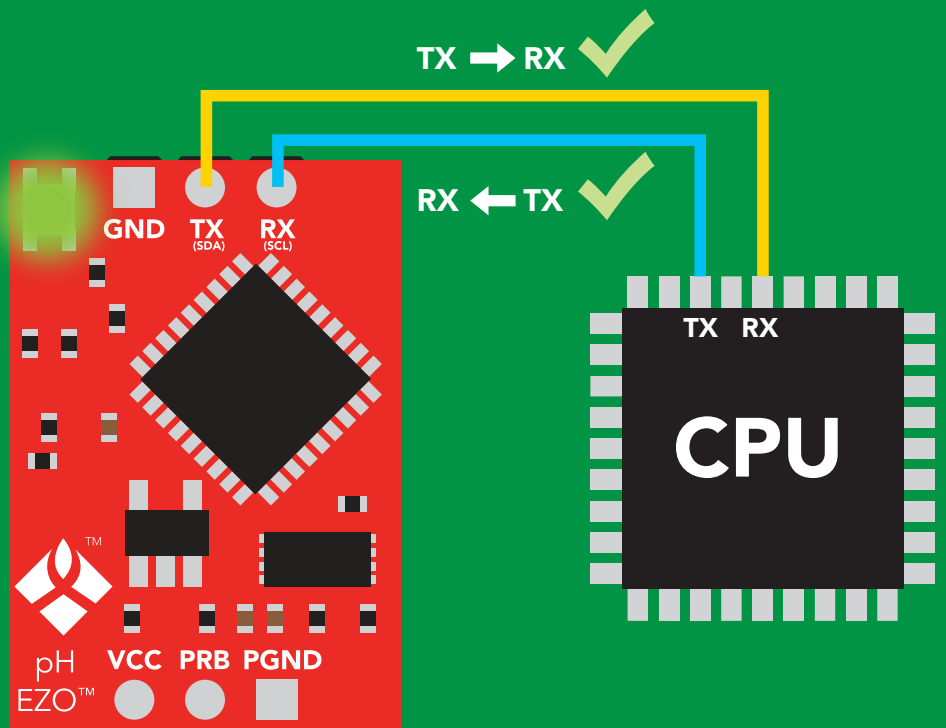

Data format

Reading	pH	Data type	floating point
Encoding	ASCII	Decimal places	3
Format	string	Smallest string	4 characters
Terminator	carriage return	Largest string	40 characters

LED color definition

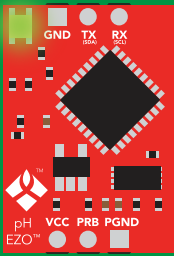

Green

UART standby

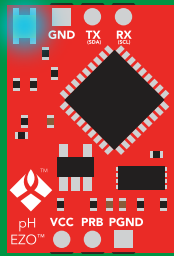

Cyan

Taking reading

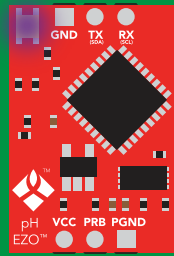

Purple

Changing
baud rate

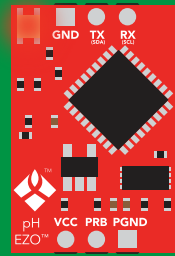

Red

Command
not understood

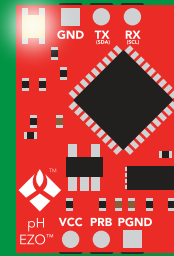

White

Find

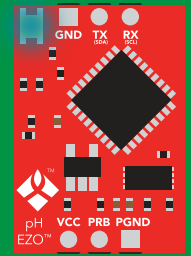

Blue

I2C standby

5V

LED ON
+2.2 mA

3.3V

+0.6 mA

Settings that are retained if power is cut

- Baud rate
- Calibration
- Continuous mode
- Device name
- Enable/disable response codes
- Hardware switch to I²C mode
- LED control
- Protocol lock
- Software switch to I²C mode

Settings that are **NOT** retained if power is cut

- Find
- Sleep mode
- Temperature compensation

Receiving data from device

2 parts

ASCII data string

Command

Carriage return <cr>

Terminator

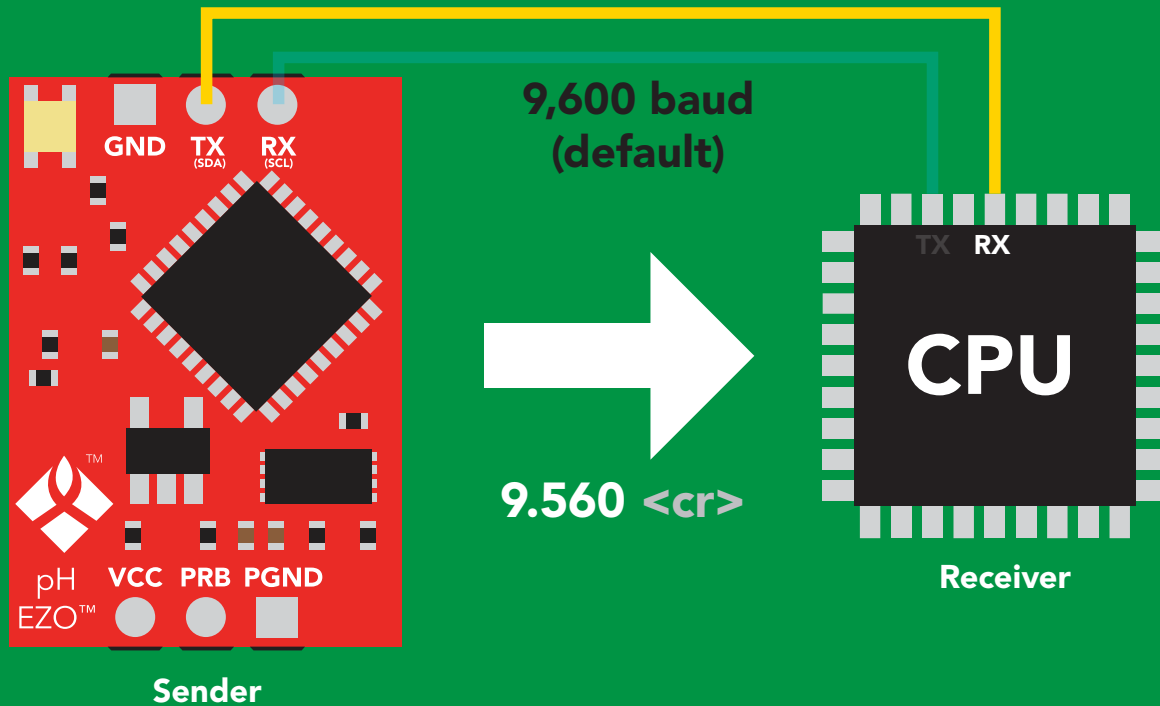

Advanced

ASCII: 9 . 5 6 0 <cr>

Hex: 39 2E 35 36 30 0D

Dec: 57 46 53 54 48 13

Sending commands to device

2 parts

Command (not case sensitive)

ASCII data string

Carriage return <cr>

Terminator

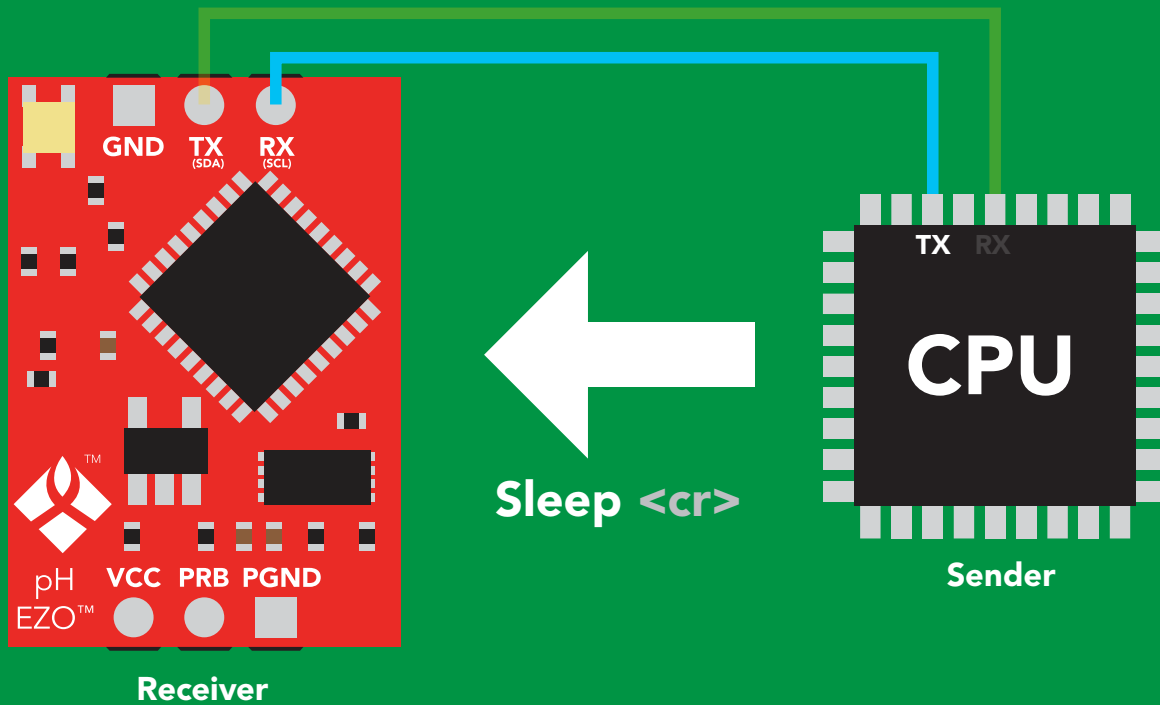

Advanced

ASCII: **S** **I** **e** **e** **p** **<cr>**

Hex: **53** **6C** **65** **65** **70** **0D**

Dec: **83** **108** **101** **101** **112** **13**

UART mode

command quick reference

All commands are ASCII strings or single ASCII characters.

Command	Function		Default state
Baud	change baud rate	pg. 33	9,600
C	enable/disable continuous reading	pg. 20	enabled
Cal	performs calibration	pg. 22	n/a
Export	export calibration	pg. 23	n/a
Factory	enable factory reset	pg. 35	n/a
Find	finds device with blinking white LED	pg. 19	n/a
i	device information	pg. 29	n/a
I2C	change to I ² C mode	pg. 36	not set
Import	import calibration	pg. 24	n/a
L	enable/disable LED	pg. 18	enabled
Name	set/show name of device	pg. 28	not set
pHext	enable/disable extended pH scale	pg. 26	disabled
Plock	enable/disable protocol lock	pg. 34	disabled
R	returns a single reading	pg. 21	n/a
Sleep	enter sleep mode/low power	pg. 32	n/a
Slope	returns the slope of the pH probe	pg. 25	n/a
Status	retrieve status information	pg. 31	enable
T	temperature compensation	pg. 27	25°C
*OK	enable/disable response codes	pg. 30	enable

LED control

Command syntax

L,1 <cr> LED on **default**

L,0 <cr> LED off

L,? <cr> LED state on/off?

Example

Response

L,1 <cr>

*OK <cr>

L,0 <cr>

*OK <cr>

L,? <cr>

?L,1 <cr> or ?L,0 <cr>
*OK <cr>

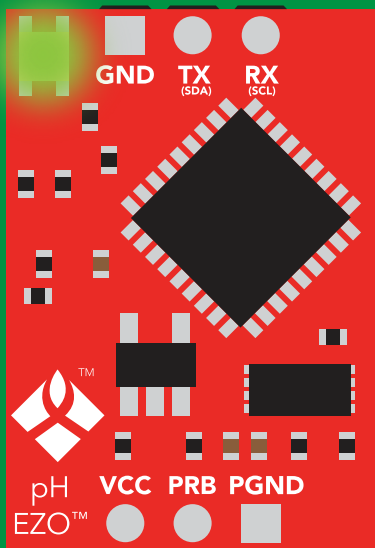

L,1

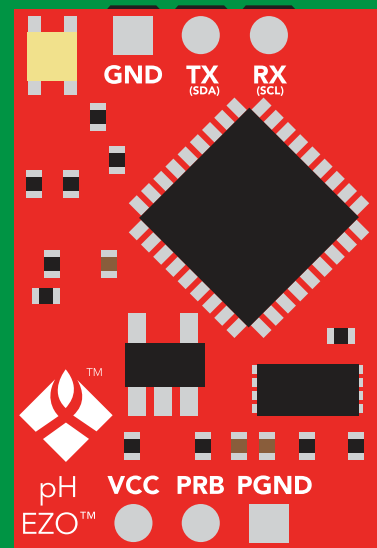

L,0

Find

Command syntax

This command will disable continuous mode
Send any character or command to terminate find.

Find <cr> LED rapidly blinks white, used to help find device

Example

Response

Find <cr>

*OK <cr>

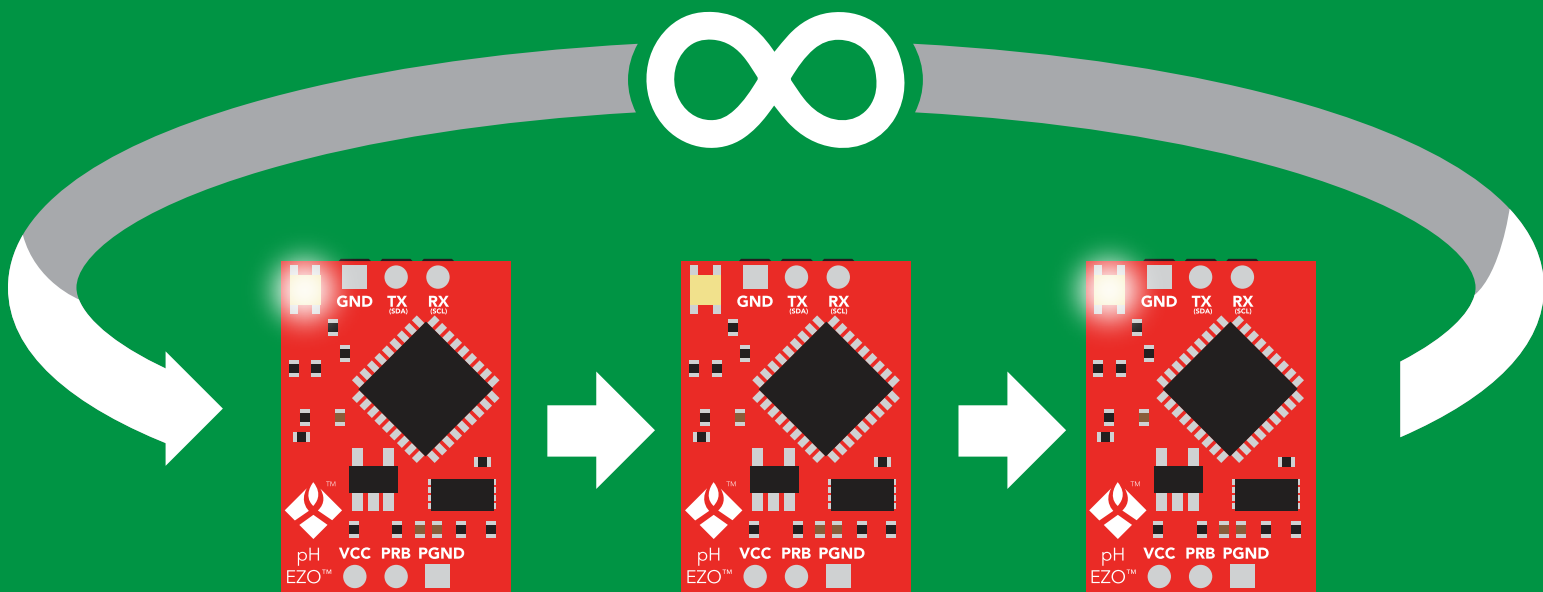

Continuous reading mode

Command syntax

- C,1 <cr>** enable continuous readings once per second **default**
- C,n <cr>** continuous readings every n seconds (n = 2 to 99 sec)
- C,0 <cr>** disable continuous readings
- C,? <cr>** continuous reading mode on/off?

Example

Response

C,1 <cr>

***OK <cr>**
pH (1 sec) <cr>
pH (2 sec) <cr>
pH (n sec) <cr>

C,30 <cr>

***OK <cr>**
pH (30 sec) <cr>
pH (60 sec) <cr>
pH (90 sec) <cr>

C,0 <cr>

***OK <cr>**

C,? <cr>

?C,1 <cr> or ?C,0 <cr> or ?C,30 <cr>
***OK <cr>**

Single reading mode

Command syntax

A single reading takes 800ms

R <cr> takes single reading

Example

R <cr>

Response

9.560 <cr>
*OK <cr>

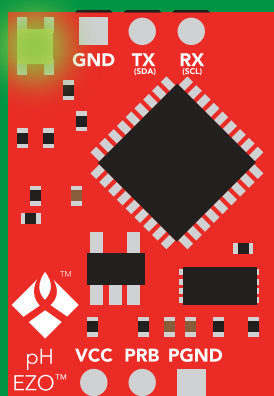

Green
Standby

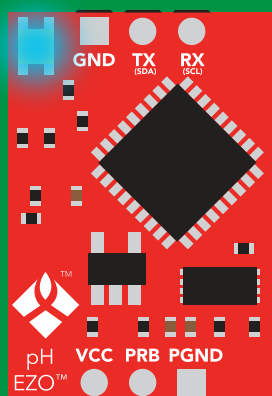

Cyan
Taking reading

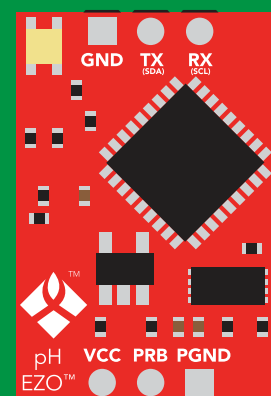

Transmitting



800 ms

Calibration

Command syntax

Issuing the cal,mid command after the EZO™ pH circuit has been calibrated, will clear the other calibration points. Full calibration will have to be redone.

- Cal,mid,n <cr> single point calibration at midpoint
- Cal,low,n <cr> two point calibration at lowpoint
- Cal,high,n <cr> three point calibration at highpoint
- Cal,clear <cr> delete calibration data
- Cal,? <cr> device calibrated?

Example

Response

Cal,mid,7.00 <cr>

*OK <cr>

Cal,low,4.00 <cr>

*OK <cr>

Cal,high,10.00 <cr>

*OK <cr>

Cal,clear <cr>

*OK <cr>

Cal,? <cr>

?Cal,0 <cr> or ?Cal,1 <cr> or
one point
?Cal,2 <cr> or ?Cal,3 <cr>
two point three point
*OK <cr>

Export calibration

Command syntax

Export: Use this command to download calibration settings

Export,? <cr> calibration string info

Export <cr> export calibration string from calibrated device

Example

Response

Export,? <cr>

10,120 <cr>

Response breakdown

10, 120

of strings to export

of bytes to export

Export strings can be up to 12 characters long, and is always followed by <cr>

Export <cr>

59 6F 75 20 61 72 <cr> (1 of 10)

Export <cr>

65 20 61 20 63 6F <cr> (2 of 10)

(7 more)

⋮

Export <cr>

6F 6C 20 67 75 79 <cr> (10 of 10)

Export <cr>

***DONE**

Disabling *OK simplifies this process

Export <cr>

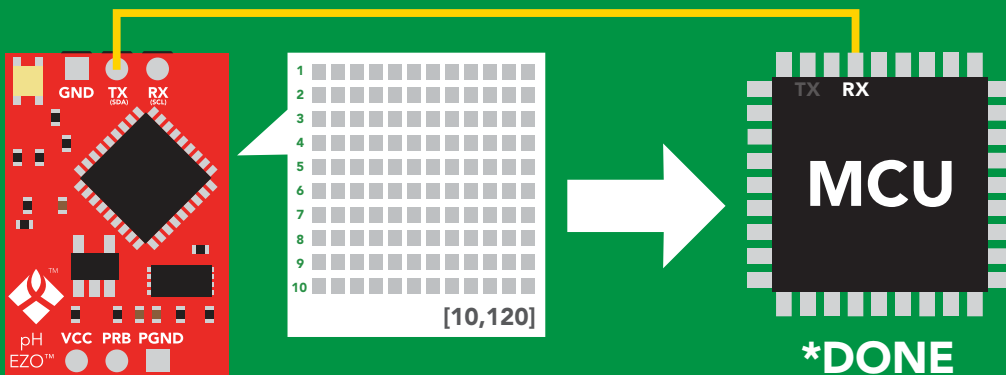

Import calibration

Command syntax

Import: Use this command to upload calibration settings to one or more devices.

Import,n <cr> import calibration string to new device

Example

Import, 59 6F 75 20 61 72 <cr> (1 of 10)

Import, 65 20 61 20 63 6F <cr> (2 of 10)

⋮

Import, 6F 6C 20 67 75 79 <cr> (10 of 10)

Response

*OK <cr>

*OK <cr>

⋮

*OK <cr>

Import,n <cr>

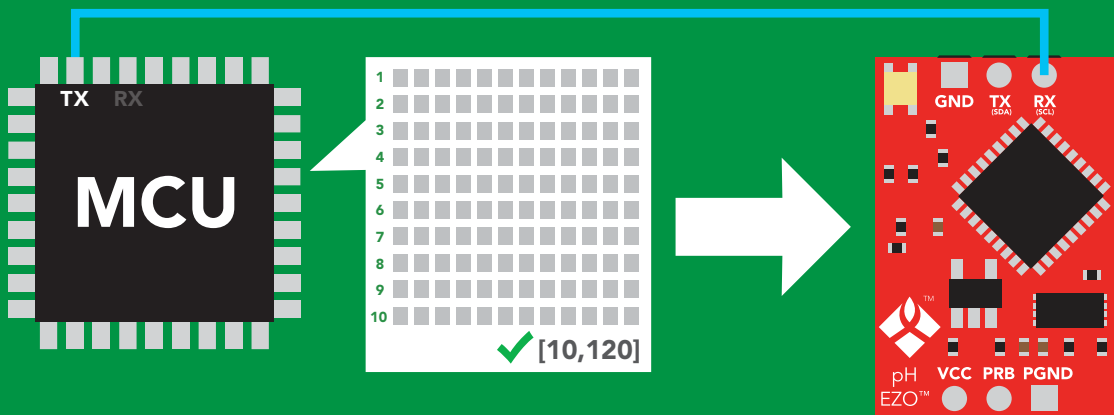

*OK <cr>

system will reboot

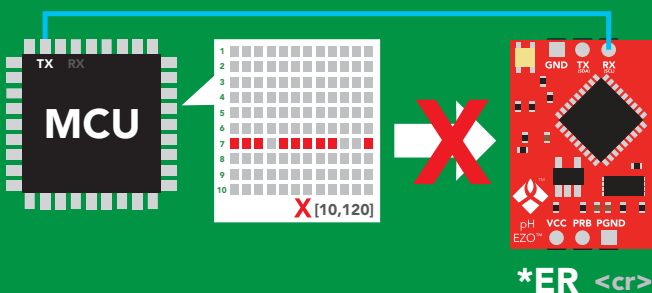

* If one of the imported strings is not correctly entered, the device will not accept the import, respond with *ER and reboot.

Slope

Command syntax

After calibrating a pH probe issuing the slope command will show how closely (in percentage) the calibrated pH probe is working compared to the "ideal" pH probe.

`Slope,?` `<cr>` returns the slope of the pH probe

Example

```
Slope,? <cr>
```

Response

```
?Slope,99.7,100.3, -0.89 <cr>  
*OK <cr>
```

Response breakdown

`?Slope,`

99.7

↑
99.7% is how closely the slope of the **acid** calibration line matched the "ideal" pH probe.

100.3

↑
100.3% is how closely the slope of the **base** calibration matches the "ideal" pH probe.

-0.89

↑
This is how many millivolts the zero point is off from true 0.

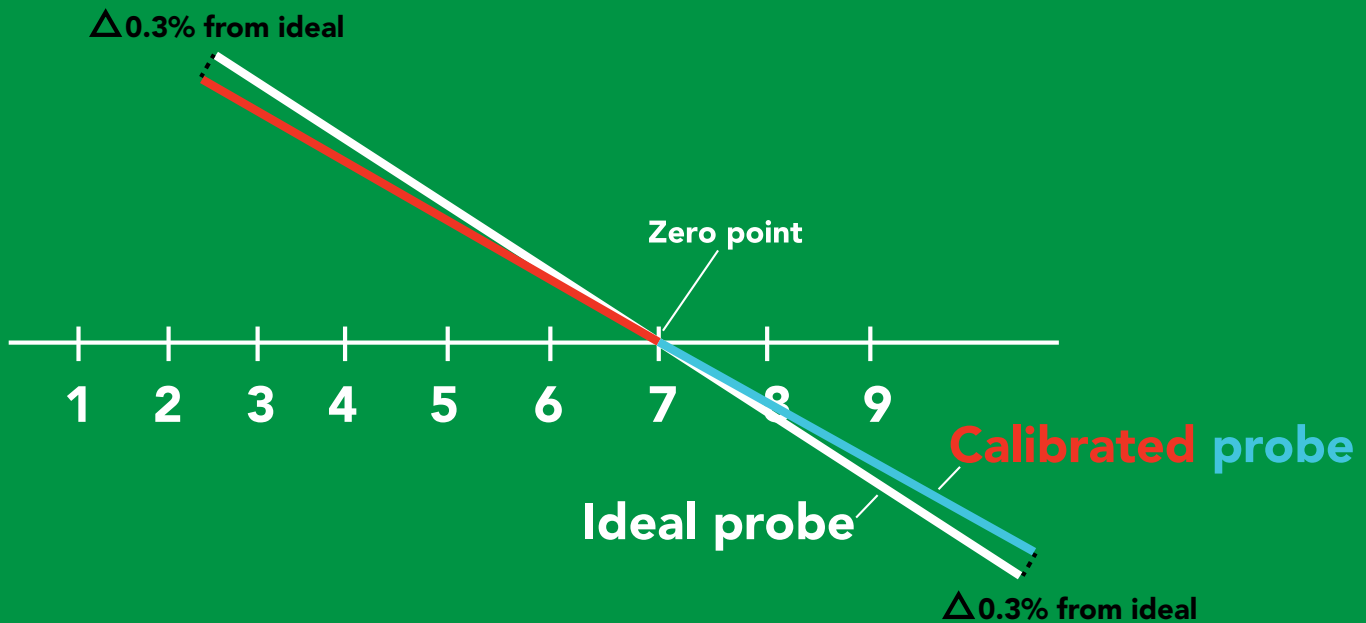

Extended pH scale

Very strong acids and bases can exceed the traditional pH scale. This command extends the pH scale to show below 0 and above 14.

Lowest possible reading: **-1.6**
Highest possible reading: **15.6**

Command syntax

- `pHext,0 <cr>` extended pH scale off (0–14) **default**
- `pHext,1 <cr>` extended pH scale on (-1.6–15.6)
- `pHext,? <cr>` extended pH scale on/off?

Example

Response

`pHext,1 <cr>`

`*OK <cr>`

`pHext,0 <cr>`

`*OK <cr>`

`pHext,? <cr>`

`?pHext,1 <cr>` or `?pHext,0 <cr>`

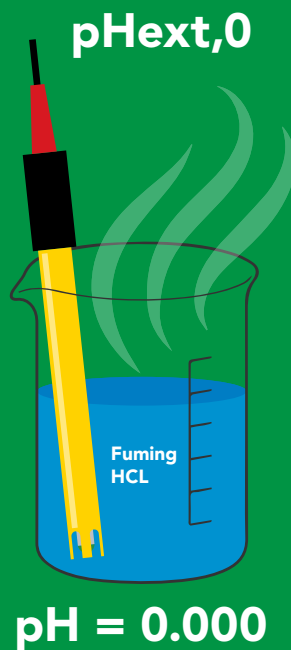

Temperature compensation

Command syntax

Default temperature = 25°C
Temperature is always in Celsius
Temperature is not retained if power is cut

T,n <cr> n = any value; floating point or int

T,? <cr> compensated temperature value?

RT,n <cr> set temperature compensation and take a reading

Example

Response

T,19.5 <cr>

***OK** <cr>

RT,19.5 <cr>

***OK** <cr>
8.91 <cr>

T,? <cr>

?T,19.5 <cr>
***OK** <cr>

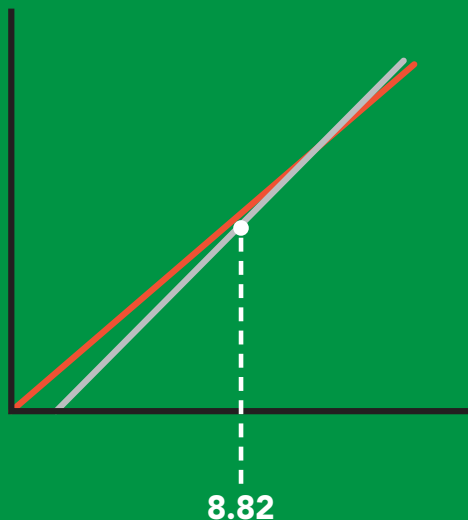

→
T,19.5 <cr>

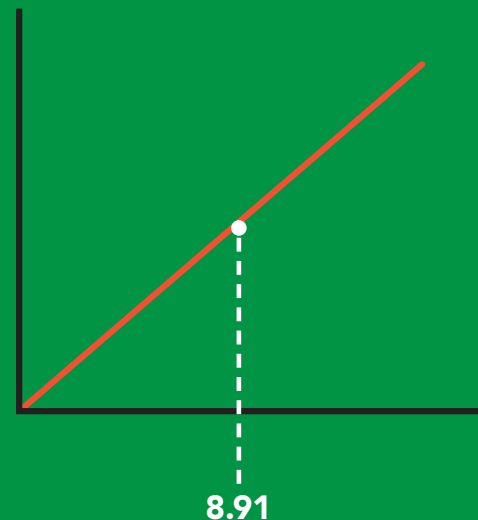

Naming device

Command syntax

Do not use spaces in the name

Name,n <cr> set name

Name, <cr> clears name

Name,? <cr> show name

n =

1 2 3 4 5 6 7 8 9 10 11 12 13 14 15 16

Up to 16 ASCII characters

Example

Response

Name, <cr>

*OK <cr> name has been cleared

Name,zzt <cr>

*OK <cr>

Name,? <cr>

?Name,zzt <cr>
*OK <cr>

Name,zzt

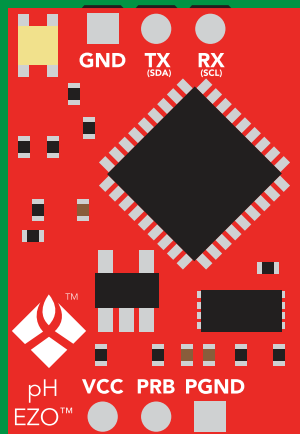

*OK <cr>

Name,?

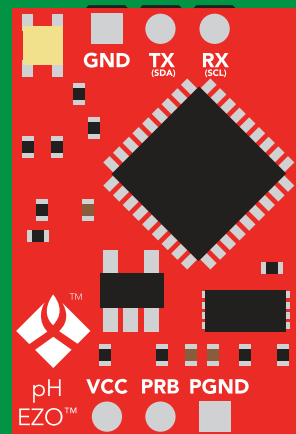

?Name,zzt <cr>
*OK <cr>

Device information

Command syntax

```
i <cr> device information
```

Example

```
i <cr>
```

Response

```
?i,pH,2.16 <cr>  
*OK <cr>
```

Response breakdown

?i,	pH,	2.16
	↑	↑
	Device	Firmware

Response codes

Command syntax

***OK,1** <cr> enable response **default**

***OK,0** <cr> disable response

***OK,?** <cr> response on/off?

Example

Response

R <cr>

9.560 <cr>
***OK** <cr>

***OK,0** <cr>

no response, ***OK** disabled

R <cr>

9.560 <cr> ***OK** disabled

***OK,?** <cr>

?*OK,1 <cr> or **?*OK,0** <cr>

Other response codes

***ER** unknown command
***OV** over volt ($VCC \geq 5.5V$)
***UV** under volt ($VCC \leq 3.1V$)
***RS** reset
***RE** boot up complete, ready
***SL** entering sleep mode
***WA** wake up

These response codes
cannot be disabled

Reading device status

Command syntax

Status <cr> voltage at Vcc pin and reason for last restart

Example

```
Status <cr>
```

Response

```
?Status,P,5.038 <cr>  
*OK <cr>
```

Response breakdown

?Status,	P,	5.038
	↑	↑
	Reason for restart	Voltage at Vcc

Restart codes

P	powered off
S	software reset
B	brown out
W	watchdog
U	unknown

Sleep mode/low power

Command syntax

Send any character or command to awaken device.

Sleep <cr> enter sleep mode/low power

Example

Response

Sleep <cr>

*OK <cr>

*SL <cr>

Any command

*WA <cr> wakes up device

5V

STANDBY

16 mA

SLEEP

1.16 mA

3.3V

13.9 mA

0.995 mA

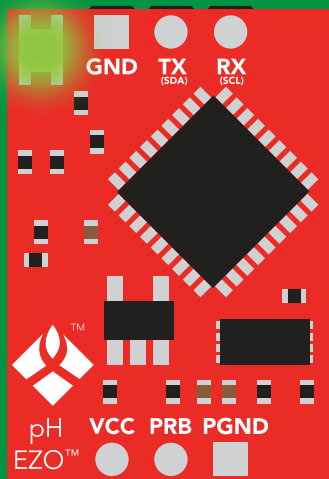

Standby
16 mA

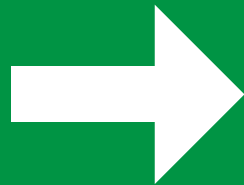

Sleep <cr>

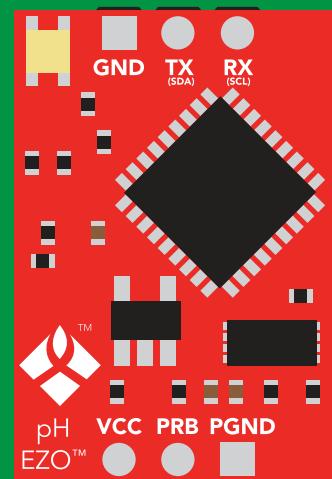

Sleep
1.16 mA

Change baud rate

Command syntax

Baud,n <cr> change baud rate

Example

Baud,38400 <cr>

Response

*OK <cr>

Baud,? <cr>

?Baud,38400 <cr>

*OK <cr>

n =

- 300
- 1200
- 2400
- 9600 default**
- 19200
- 38400
- 57600
- 115200

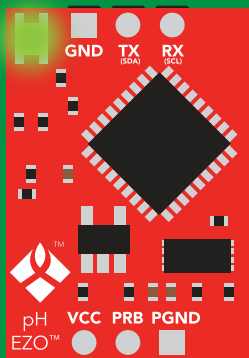

Standby

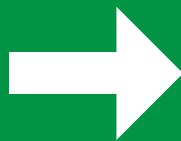

Baud,38400 <cr>

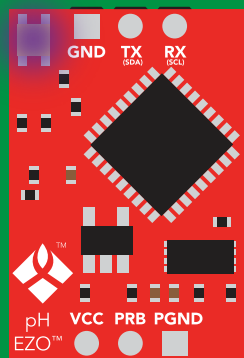

Changing
baud rate

*OK <cr>



(reboot)

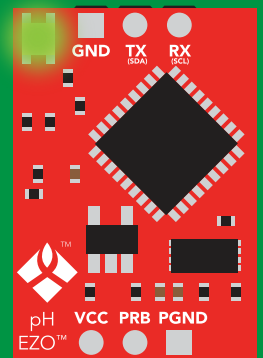

Standby

Protocol lock

Command syntax

Locks device to UART mode.

Plock,1 <cr> enable Plock

Plock,0 <cr> disable Plock **default**

Plock,? <cr> Plock on/off?

Example

Response

Plock,1 <cr>

*OK <cr>

Plock,0 <cr>

*OK <cr>

Plock,? <cr>

?Plock,1 <cr> or ?Plock,0 <cr>

Plock,1

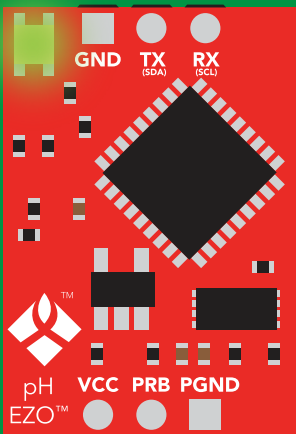

*OK <cr>

I2C,100

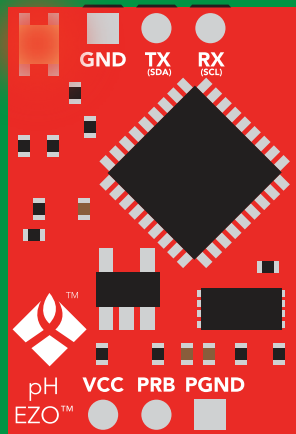

cannot change to I²C

*ER <cr>

Short

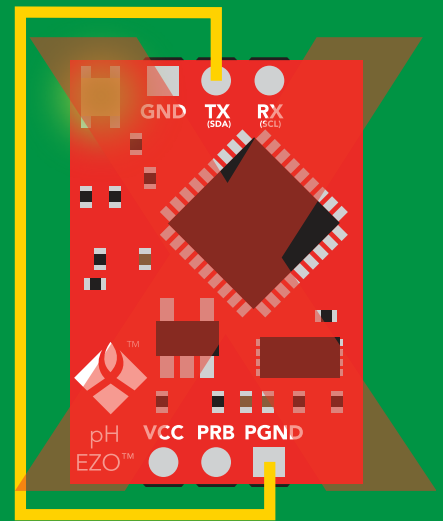

cannot change to I²C

Factory reset

Command syntax

Clears calibration
LED on
"*OK" enabled

Factory <cr> enable factory reset

Example

Response

Factory <cr>

*OK <cr>

Factory <cr>

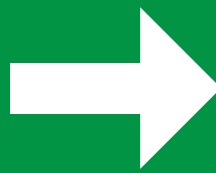
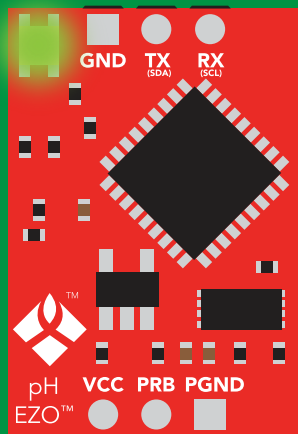

(reboot)

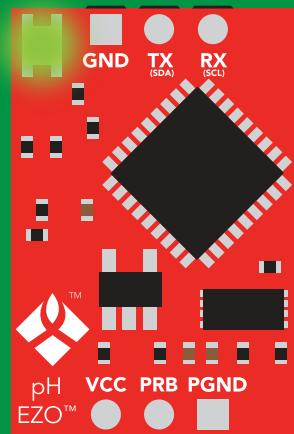

*OK <cr>

*RS <cr>

*RE <cr>

Baud rate will not change

Change to I²C mode

Command syntax

Default I²C address 99 (0x63)

I2C,n <cr> sets I²C address and reboots into I²C mode

n = any number 1 – 127

Example

Response

I2C,100 <cr>

*OK (reboot in I²C mode)

Wrong example

Response

I2C,139 <cr> n ≠ 127

*ER <cr>

I2C,100

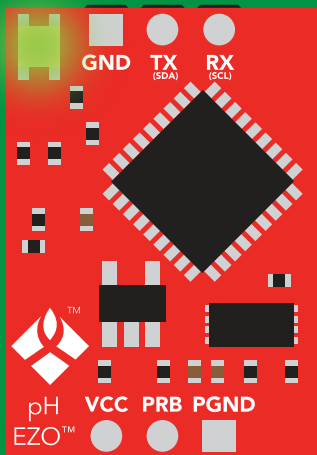

Green
*OK <cr>

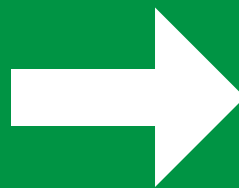

(reboot)

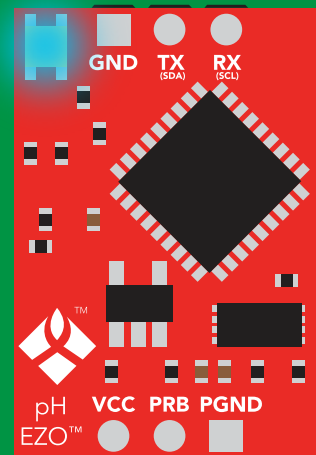

Blue
now in I²C mode

Manual switching to I²C

- Disconnect ground (power off)
- Disconnect TX and RX
- Connect TX to PGND
- Confirm RX is disconnected
- Connect ground (power on)
- Wait for LED to change from **Green** to **Blue**
- Disconnect ground (power off)
- Reconnect all data and power

Manually switching to I²C will set the I²C address to 99 (0x63)

Example

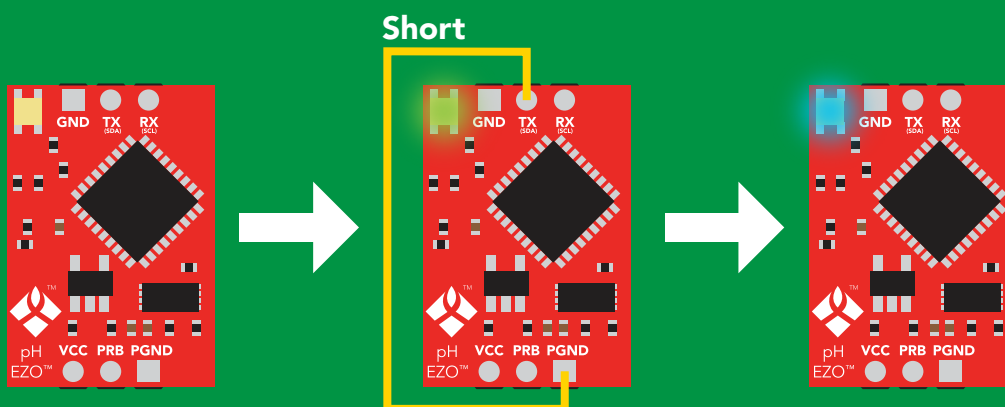

Wrong Example

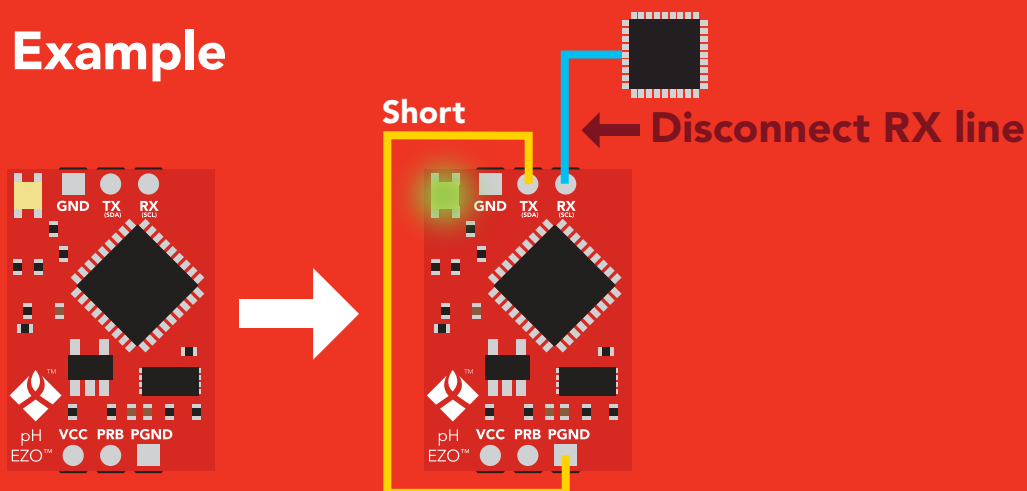

I²C mode

The I²C protocol is **considerably more complex** than the UART (RS-232) protocol. Atlas Scientific assumes the embedded systems engineer understands this protocol.

To set your EZO™ device into I²C mode click [here](#)

Settings that are retained if power is cut

- Calibration
- Change I²C address
- Hardware switch to UART mode
- LED control
- Protocol lock
- Software switch to UART mode

Settings that are **NOT** retained if power is cut

- Find
- Sleep mode
- Temperature compensation

I²C mode

I²C address (0x01 – 0x7F)
99 (0x63) default

V_{cc} 3.3V – 5.5V

Clock speed 100 – 400 kHz

SDA 

SCL 



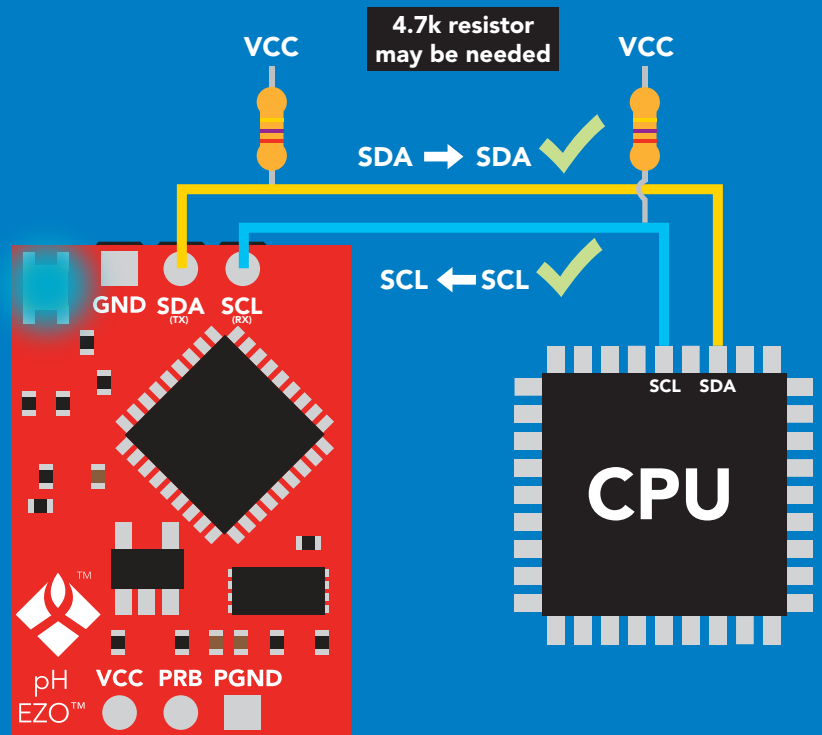

Data format

Reading	pH	Data type	floating point
Units	pH	Decimal places	3
Encoding	ASCII	Smallest string	4 characters
Format	string	Largest string	40 characters

Sending commands to device

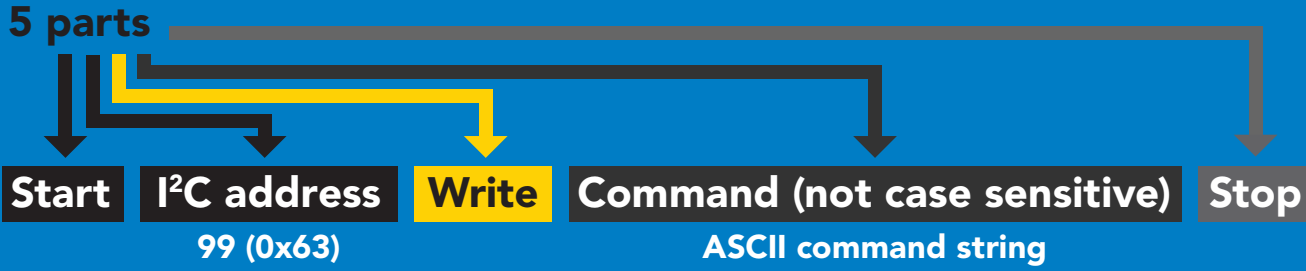

Example

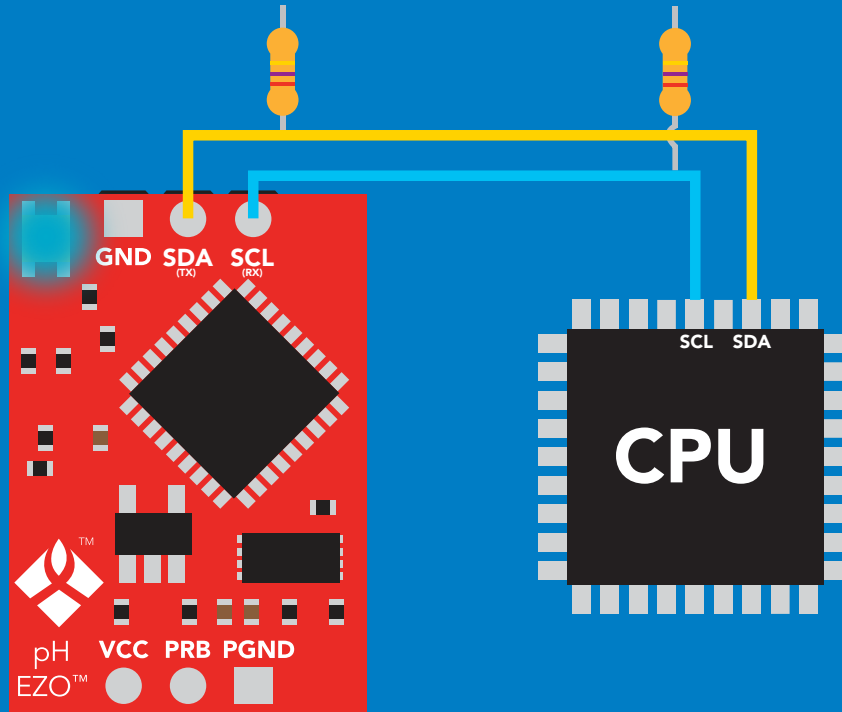

Advanced

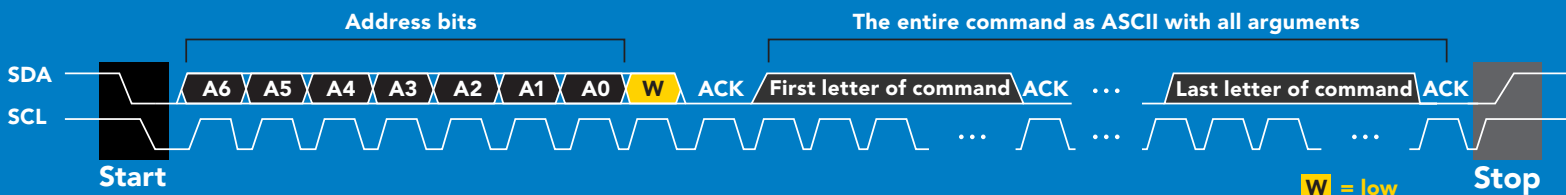

Response codes

After a command has been issued, a 1 byte response code can be read in order to confirm that the command was processed successfully.

Reading back the response code is completely optional, and is not required for normal operation.

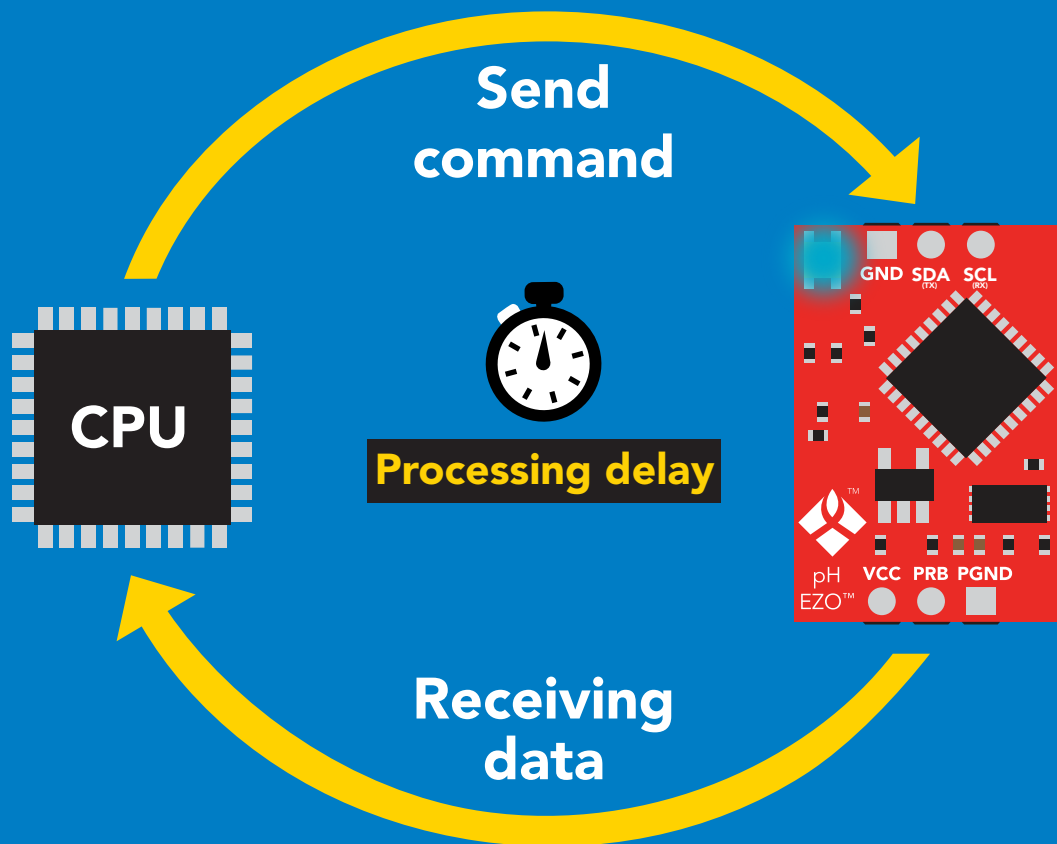

Example

```
I2C_start;  
I2C_address;  
I2C_write(EZO_command);  
I2C_stop;
```

```
delay(300);
```



```
Processing delay
```

```
I2C_start;  
I2C_address;  
Char[ ] = I2C_read;  
I2C_stop;
```

If there is no processing delay or the processing delay is too short, the response code will always be 254.

Response codes

Single byte, not string

255	no data to send
254	still processing, not ready
2	syntax error
1	successful request

LED color definition

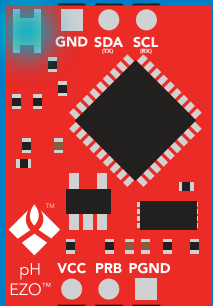

Blue

I²C standby

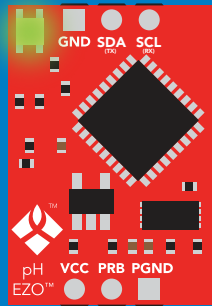

Green

Taking reading

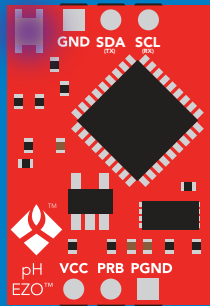

Purple

Changing
I²C address

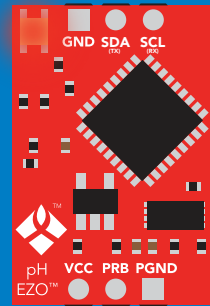

Red

Command
not understood

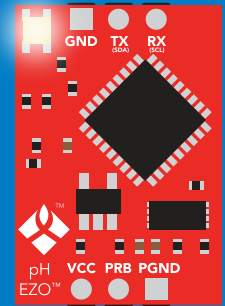

White

Find

5V

LED ON
+2.2 mA

3.3V

+0.6 mA

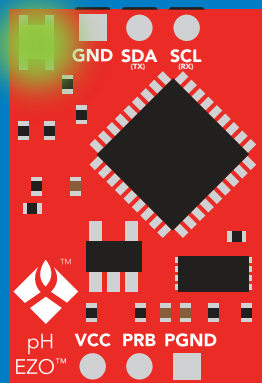

Solid Green LED

in UART mode
Not I²C ready

I²C mode

command quick reference

All commands are ASCII strings or single ASCII characters.

Command	Function	
Baud	switch back to UART mode	pg. 61
Cal	performs calibration	pg. 48
Export	export calibration	pg. 49
Factory	enable factory reset	pg. 60
Find	finds device with blinking white LED	pg. 46
i	device information	pg. 55
I2C	change I ² C address	pg. 59
Import	import calibration	pg. 50
L	enable/disable LED	pg. 45
Name	set/show name of device	pg. 54
pHext	enable/disable extended pH scale	pg. 52
Plock	enable/disable protocol lock	pg. 58
R	returns a single reading	pg. 47
Sleep	enter sleep mode/low power	pg. 57
Slope	returns the slope of the pH probe	pg. 51
Status	retrieve status information	pg. 56
T	temperature compensation	pg. 53

LED control

Command syntax

300ms  processing delay

L,1 LED on **default**

L,0 LED off

L,? LED state on/off?

Example

Response

L,1



Wait 300ms **1** **0**
Dec Null

L,0

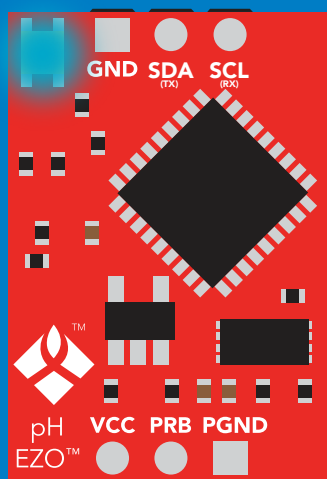

Wait 300ms **1** **0**
Dec Null

L,?

Wait 300ms **1** **?L,1** **0** or **1** **?L,0** **0**
Dec ASCII Null Dec ASCII Null

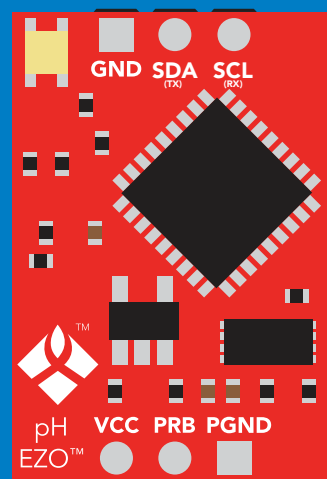

L,1



L,0

Find

300ms  processing delay

Command syntax

This command will disable continuous mode
Send any character or command to terminate find.

Find LED rapidly blinks white, used to help find device

Example

Response

Find



1 0
Dec Null

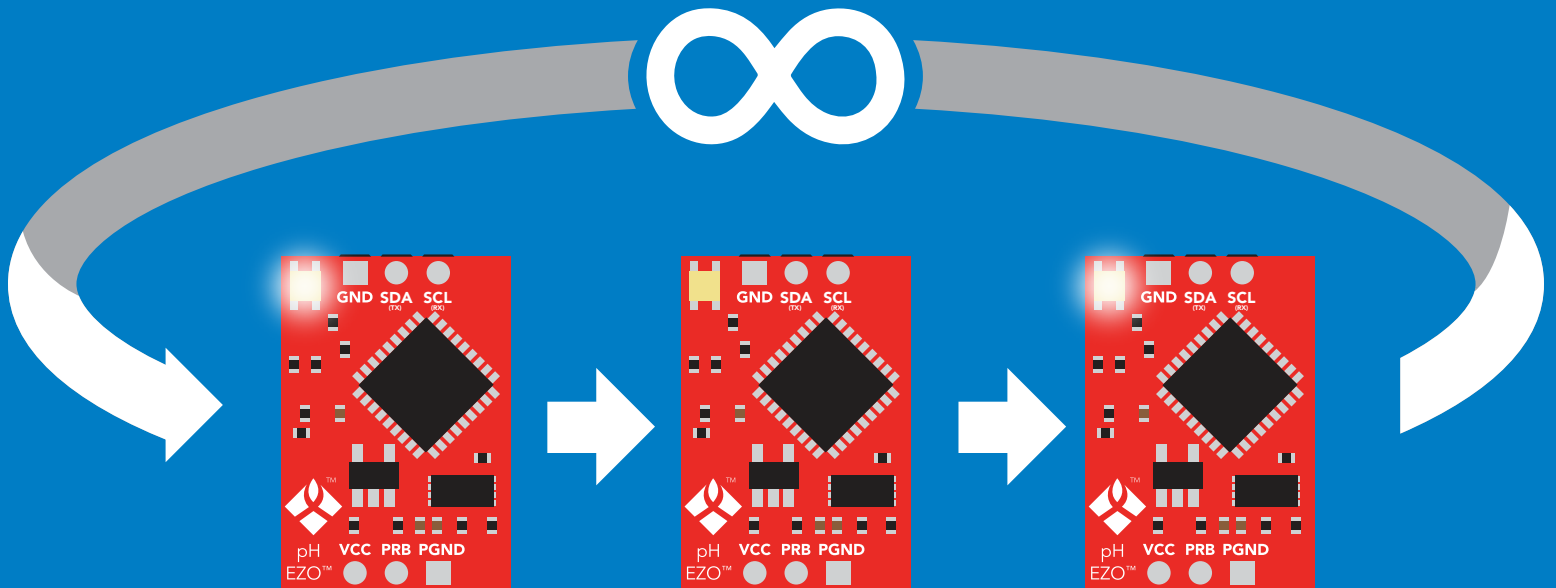

Taking reading

Command syntax

900ms  processing delay

R return 1 reading

Example

Response

R

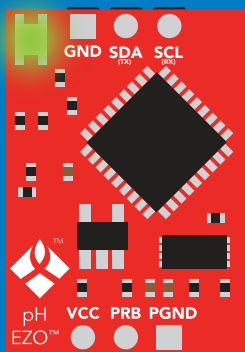

Wait 900ms

1	9.560	0
Dec	ASCII	Null

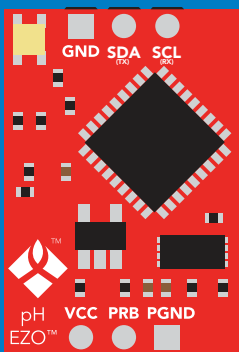
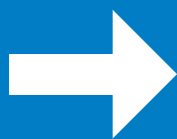

Green

Taking reading



Transmitting

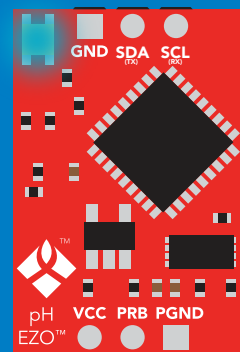
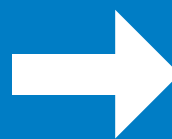

Blue

Standby

Export calibration

300ms  processing delay

Command syntax

Export: Use this command to download calibration settings

Export,? calibration string info

Export export calibration string from calibrated device

Example

Response

Export,?



Wait 300ms

1

Dec

10,120

ASCII

0

Null

Response breakdown

10, 120

of strings to export # of bytes to export

Export strings can be up to 12 characters long

Export



Wait 300ms

1

Dec

59 6F 75 20 61 72

ASCII

0

Null

(1 of 10)

Export



Wait 300ms

1

Dec

65 20 61 20 63 6F

ASCII

0

Null

(2 of 10)

(7 more)

⋮

Export



Wait 300ms

1

Dec

6F 6C 20 67 75 79

ASCII

0

Null

(10 of 10)

Export



Wait 300ms

1

Dec

*DONE

ASCII

0

Null

Import calibration

300ms  processing delay

Command syntax

Import: Use this command to upload calibration settings to one or more devices.

Import,n import calibration string to new device

Example

Import, 59 6F 75 20 61 72 (1 of 10)

Import, 65 20 61 20 63 6F (2 of 10)

⋮

Import, 6F 6C 20 67 75 79 (10 of 10)

Response

 **1** **0**
Wait 300ms Dec Null

 **1** **0**
Wait 300ms Dec Null

⋮

 **1** **0**
Wait 300ms Dec Null

Import,n

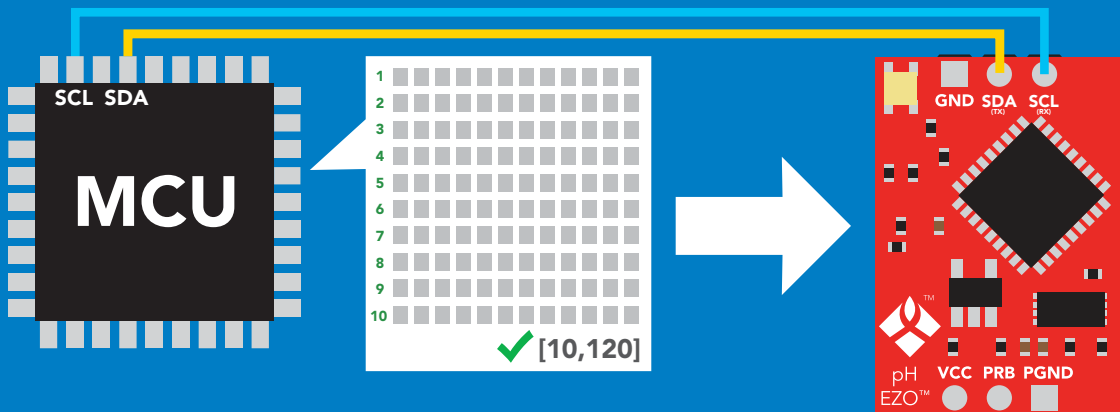

1 *Pending 0
Dec ASCII Null
system will reboot

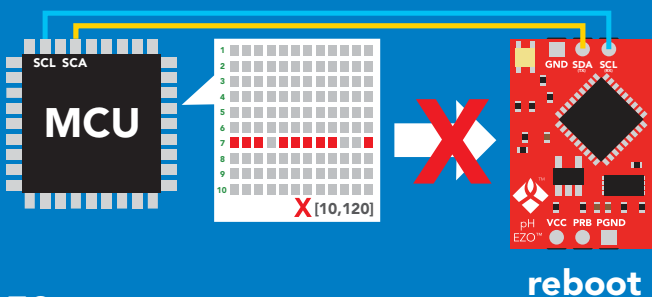

* If one of the imported strings is not correctly entered, the device will not accept the import and reboot.

Slope

300ms  processing delay

Command syntax

After calibrating a pH probe issuing the slope command will show how closely (in percentage) the calibrated pH probe is working compared to the "ideal" pH probe.

`Slope,?` returns the slope of the pH probe

Example

Response

`Slope,?`



Wait 300ms

1

Dec

`?Slope,99.7,100.3,-0.89`

ASCII

0

Null

Response breakdown

`?Slope,`

99.7

↑
99.7% is how closely the slope of the **acid** calibration line matched the "ideal" pH probe.

100.3

↑
100.3% is how closely the slope of the **base** calibration matches the "ideal" pH probe.

-0.89

↑
This is how many millivolts the zero point is off from true 0.

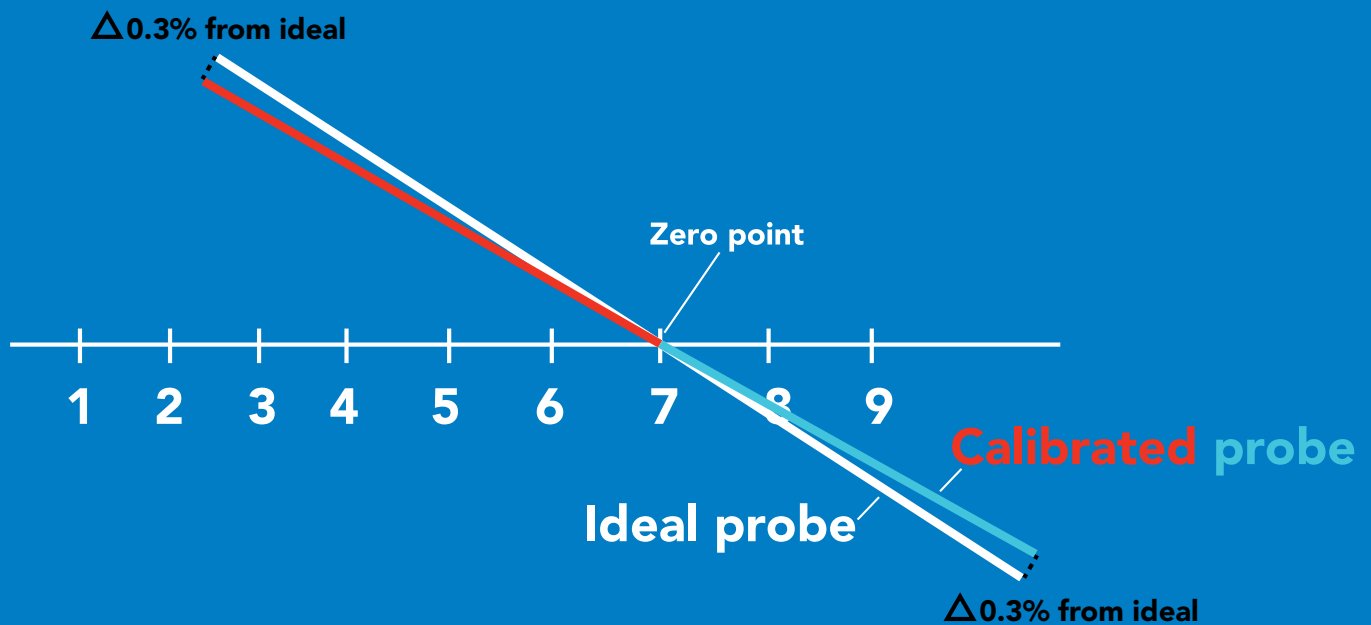

Extended pH scale

300ms  processing delay

Very strong acids and bases can exceed the traditional pH scale. This command extends the pH scale to show below 0 and above 14.

Command syntax

Lowest possible reading: **-1.6**
Highest possible reading: **15.6**

pHext,0	extended pH scale off (0 – 14)	default
pHext,1	extended pH scale on (-1.6 – 15.6)	
pHext,?	extended pH scale on/off?	

Example

Response

pHext,1

Wait 300ms **1** **0**
Dec Null

pHext,0

Wait 300ms **1** **0**
Dec Null

pHext,?

Wait 300ms **1** **?pHext,1** **0** **or** **1** **?pHext,0** **0**
Dec ASCII Null Dec ASCII Null



Temperature compensation

Command syntax

Default temperature = 25°C
Temperature is always in Celsius
Temperature is not retained if power is cut

T,n n = any value; floating point or int 300ms  processing delay
T,? compensated temperature value?
RT,n set temperature compensation and take a reading

Example

Response

T,19.5

 Wait 300ms **1** Dec **0** Null

RT,19.5

 Wait 900ms **1** Dec **8.91** ASCII **0** Null

T,?

 Wait 300ms **1** Dec **?T,19.5** ASCII **0** Null

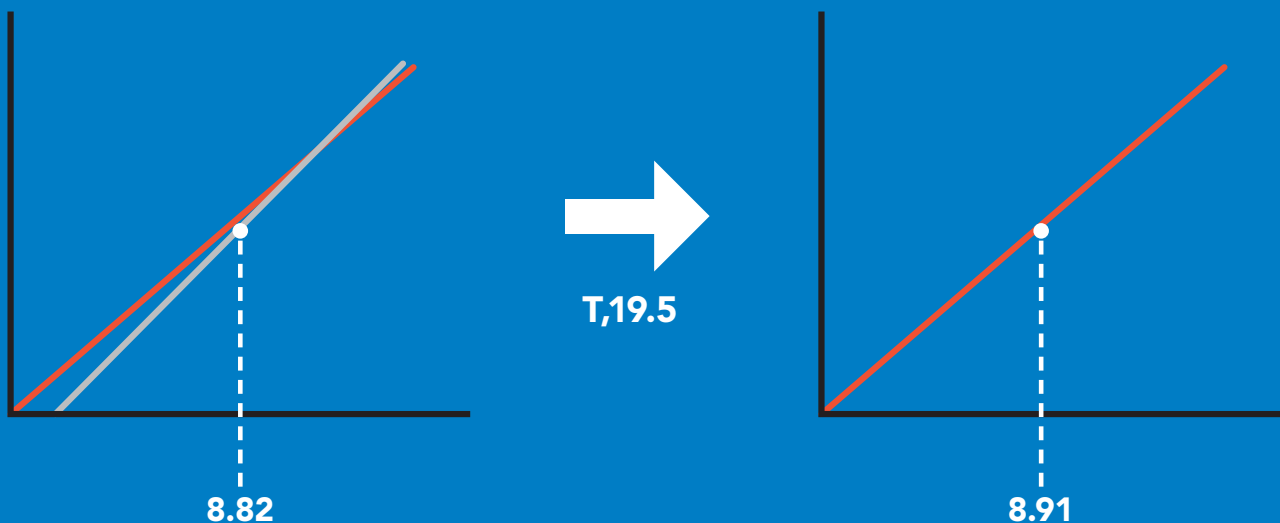

Naming device

300ms  processing delay

Command syntax

Do not use spaces in the name

Name,n	set name	n =	1	2	3	4	5	6	7	8	9	10	11	12	13	14	15	16
Name,	clears name		Up to 16 ASCII characters															
Name,?	show name																	

Example

Response

Name,



1 0
Dec Null

name has been cleared

Name,zzt



1 0
Dec Null

Name,?



1 ?Name,zzt 0
Dec ASCII Null

Name,zzt

Name,?

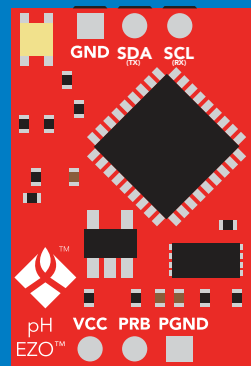
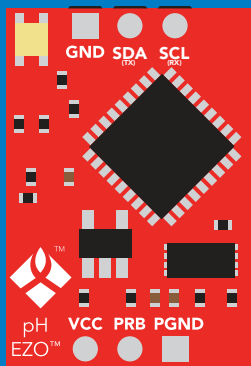

1 0

1 ?Name,zzt 0

Device information

Command syntax

300ms  processing delay

i device information

Example

Response

i



Wait 300ms

1

Dec

?i,pH,1.98

ASCII

0

Null

Response breakdown

?i,	pH,	1.98
	↑	↑
	Device	Firmware

Reading device status

Command syntax

300ms  processing delay

Status voltage at Vcc pin and reason for last restart

Example

Response

Status

 **1** **?Status,P,5.038** **0**
Wait 300ms Dec ASCII Null

Response breakdown

?Status, **P,** **5.038**
Reason for restart Voltage at Vcc

Restart codes

P powered off
S software reset
B brown out
W watchdog
U unknown

Sleep mode/low power

Command syntax

Sleep enter sleep mode/low power

Send any character or command to awaken device.

Example

Response

Sleep

no response

Do not read status byte after issuing sleep command.

Any command

wakes up device

5V

STANDBY

16 mA

SLEEP

1.16 mA

3.3V

13.9 mA

0.995 mA

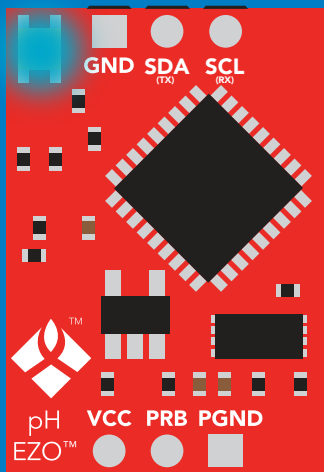

Standby

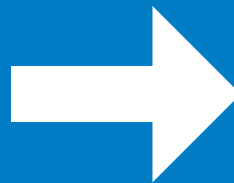

Sleep

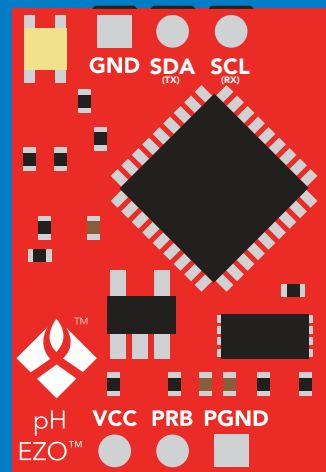

Sleep

Protocol lock

Command syntax

300ms  processing delay

Plock,1 enable Plock

Plock,0 disable Plock

Plock,? Plock on/off?

Locks device to I²C mode.

default

Example

Response

Plock,1

Wait 300ms

1	0
Dec	Null

Plock,0

Wait 300ms

1	0
Dec	Null

Plock,?

Wait 300ms

1	?Plock,1	0
Dec	ASCII	Null

Plock,1

Baud, 9600

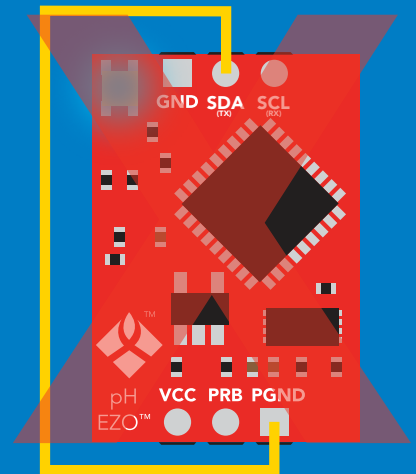
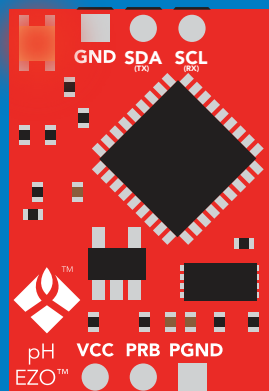
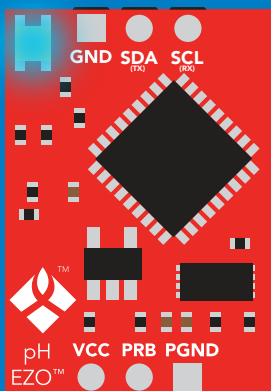

cannot change to UART

cannot change to UART

I²C address change

Command syntax

300ms  processing delay

I2C,n sets I²C address and reboots into I²C mode

Example

Response

I2C,100

device reboot
(no response given)

Warning!

Changing the I²C address will prevent communication between the circuit and the CPU until the CPU is updated with the new I²C address.

Default I²C address is 99 (0x63).

n = any number 1 – 127

I2C,100

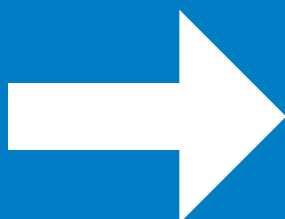
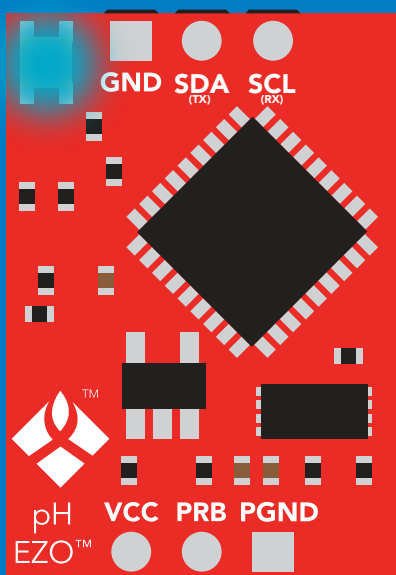

(reboot)

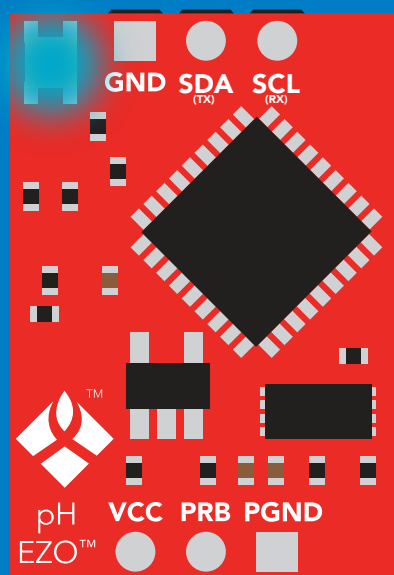

Factory reset

Command syntax

Factory reset will not take the device out of I²C mode.

Factory enable factory reset

I²C address will not change

Example

Response

Factory

device reboot
(no response given)

Clears calibration
LED on
Response codes enabled

Factory

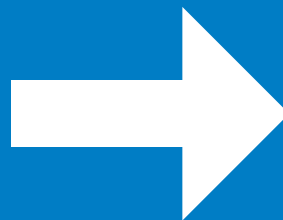
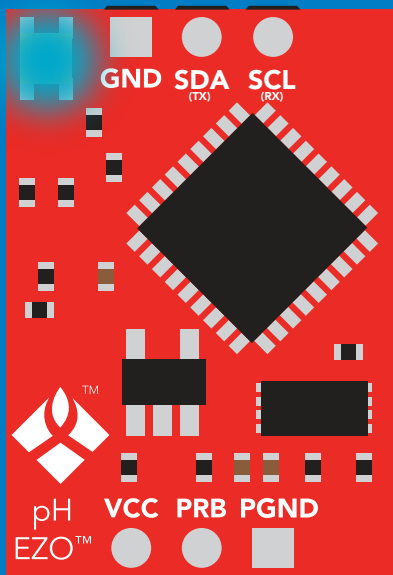

(reboot)

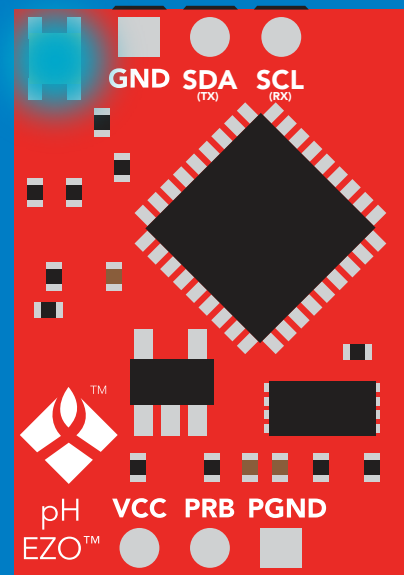

Change to UART mode

Command syntax

Baud,n switch from I²C to UART

Example

Baud,9600

Response

reboot in UART mode
(no response given)

n = [300
1200
2400
9600
19200
38400
57600
115200

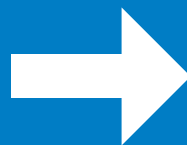
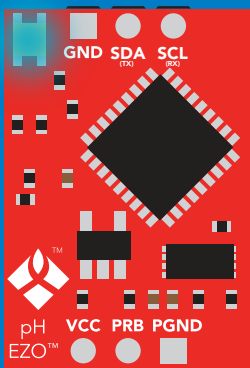

Baud,9600

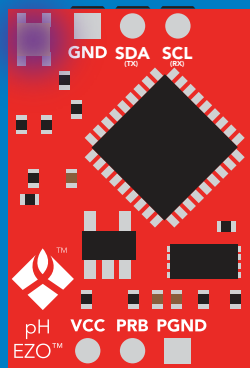

Changing to UART mode

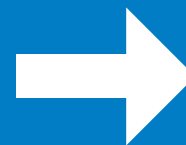

(reboot)

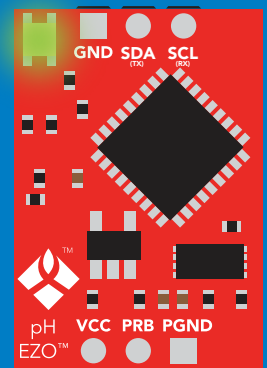

Manual switching to UART

- Disconnect ground (power off)
- Disconnect TX and RX
- Connect TX to PGND
- Confirm RX is disconnected
- Connect ground (power on)
- Wait for LED to change from Blue to Green
- Disconnect ground (power off)
- Reconnect all data and power

Example

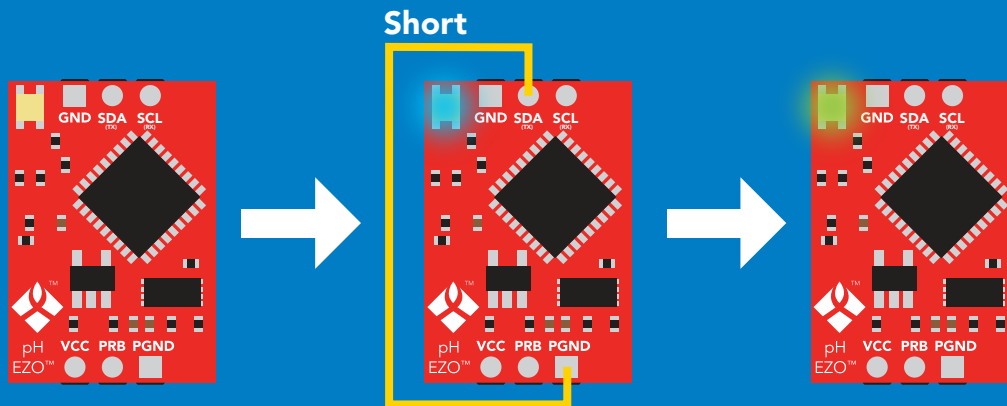

Wrong Example

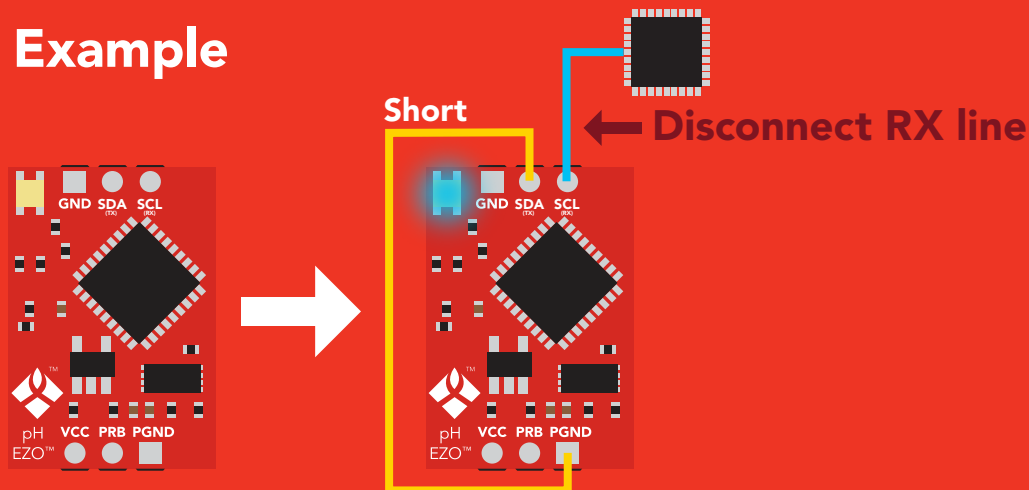

Calibration theory

The accuracy of your readings is directly related to the quality of your calibration.
(Calibration is not difficult, and a little bit of care goes a long way).

Single, Two point, or Three point calibration accuracy

Single point calibration

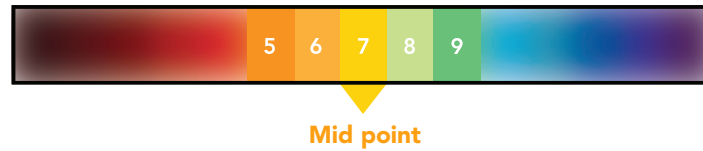

Two point calibration



Three point calibration



Confirm the pH probe is working correctly

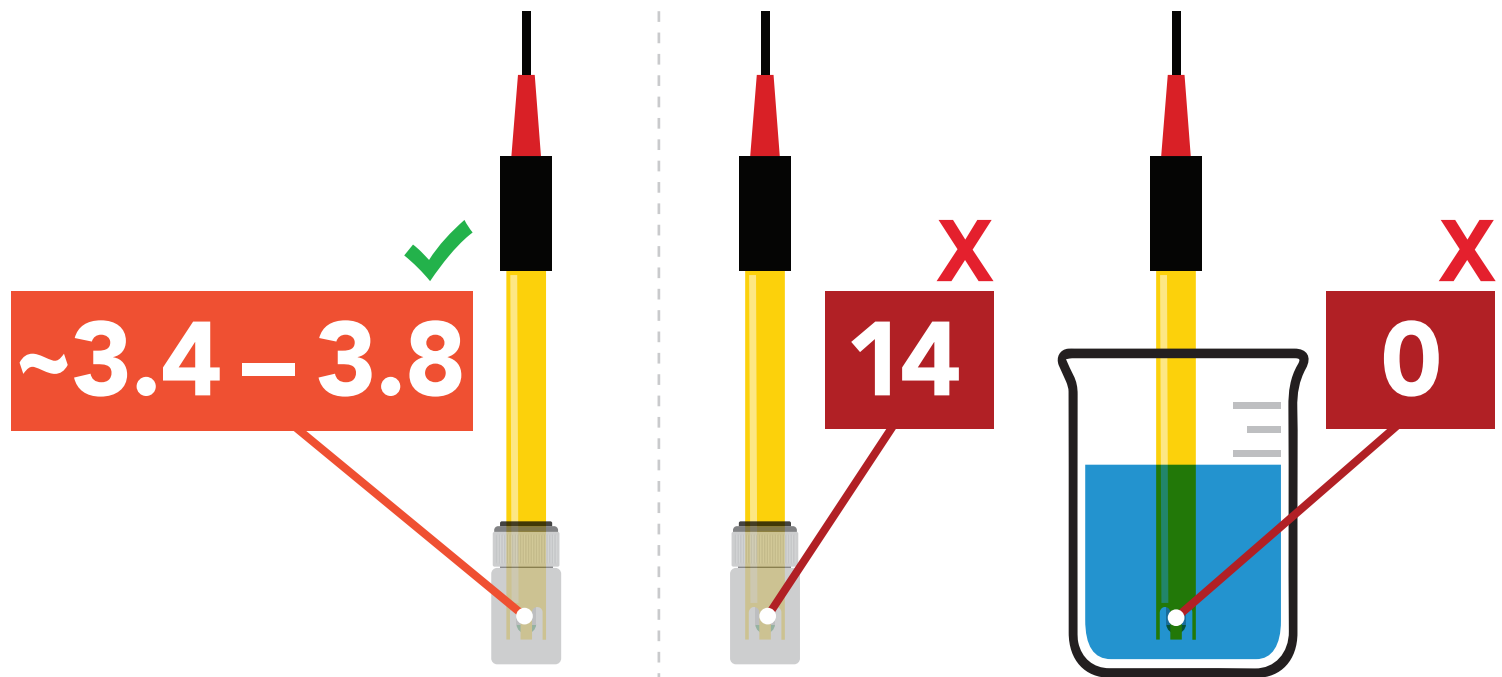

A new Atlas Scientific pH probe, still in its soaker bottle will read a pH of **~3.4-3.8**

If your pH probe gives a reading of **zero, seven** or **14** continuously and that reading cannot be changed no matter what solution the probe is in, your probe cannot be calibrated and may be damaged.

Contact Atlas Scientific customer support for assistance.

Calibration order

If this is your first time calibrating the EZO™ pH circuit, we recommend that you follow this calibration order.



Calibration solutions

The Atlas Scientific EZO™ pH circuit can work with any brand or value of calibration solution. **We recommend using calibration solutions that have simple values.**

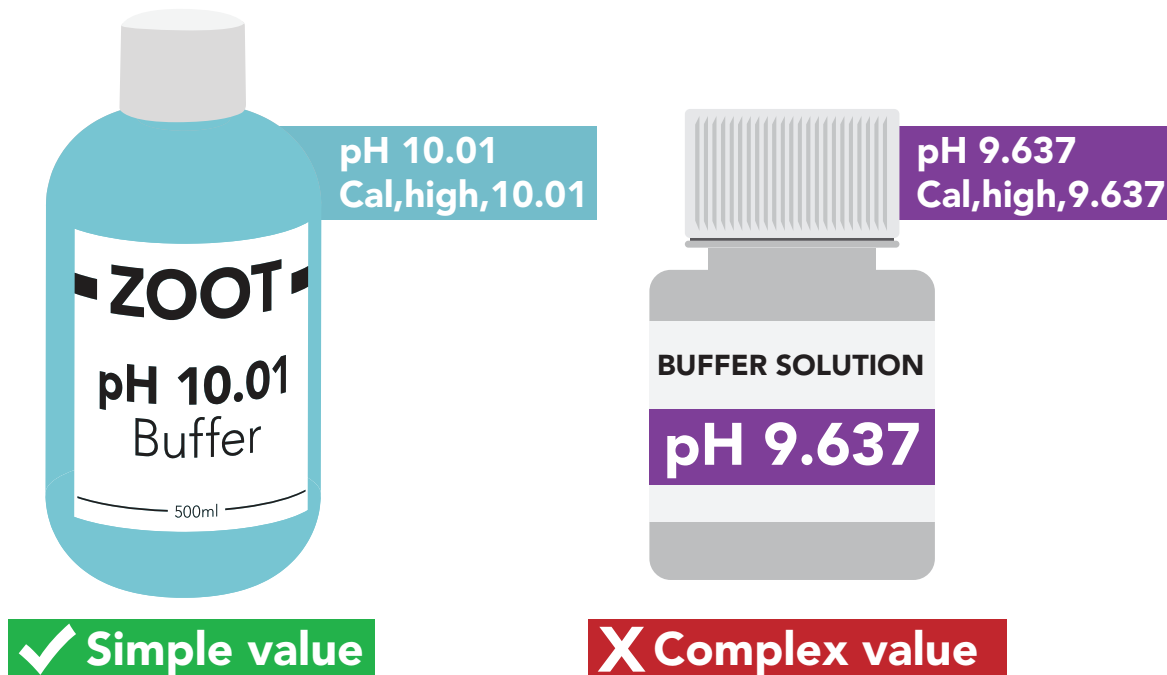

While you can use calibration solutions that have complex values, we recommend avoiding unnecessary complexity. **Unusually specific calibration values should be treated with suspicion.**

Best practices for calibration

Always watch the readings throughout the calibration process.
Issue calibration commands once the readings have stabilized.

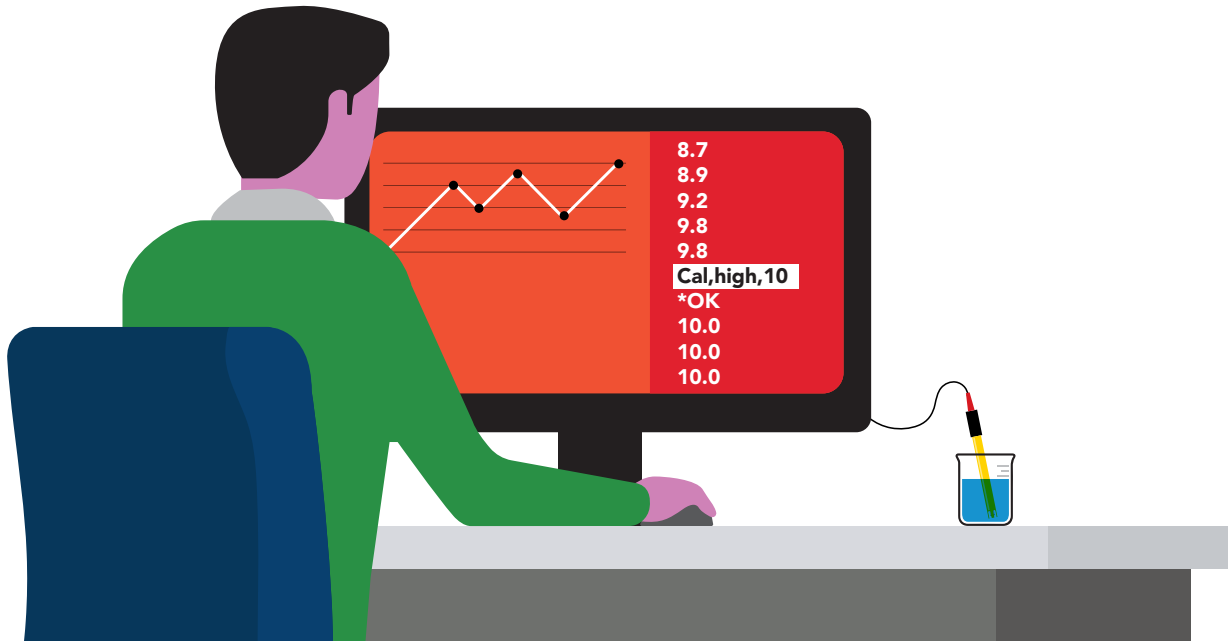

⚠ Never do a blind calibration! ⚠

Issuing a calibration command before the readings stabilize will result in drifting readings.

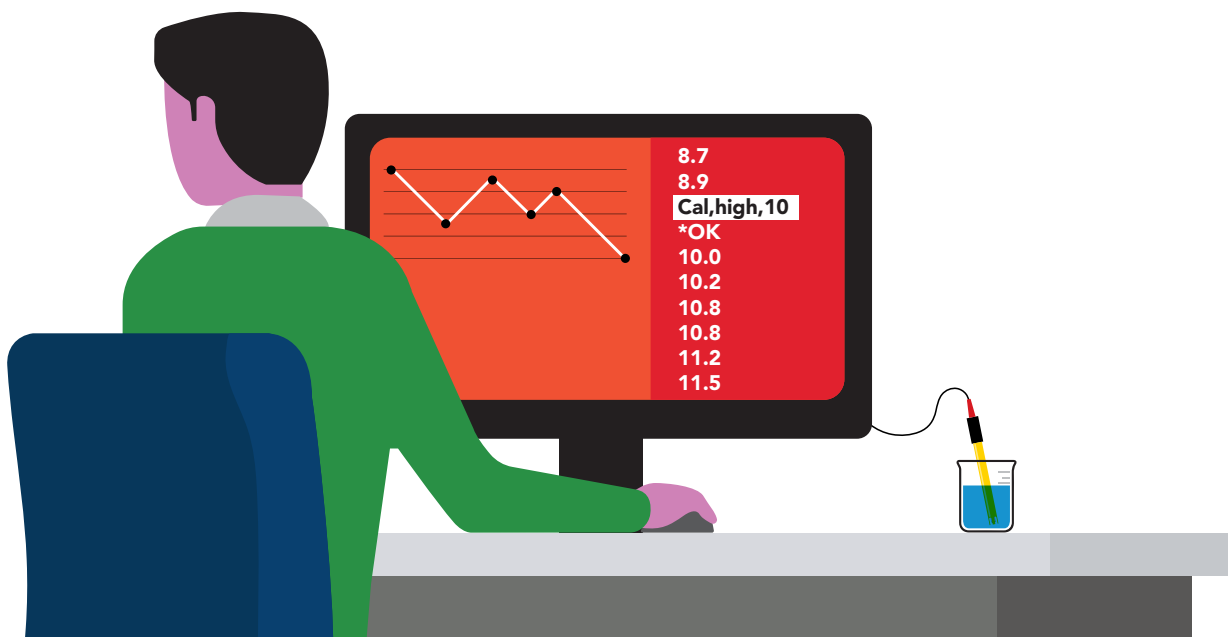

Best practices for calibration

Avoid extended stabilization time.



Letting the probes pre-calibration readings stabilize over an extended period will cause your calibrated readings to take a long time to stabilize.

Avoid frequent recalibrations.

if it ain't broke, don't fix it.

pH probes lose accuracy slowly. Frequent recalibrations to insure high accuracy will often have the opposite effect. It is far more likely that you will miscalibrate the probe rather than improve its accuracy.

1. Mid point calibration

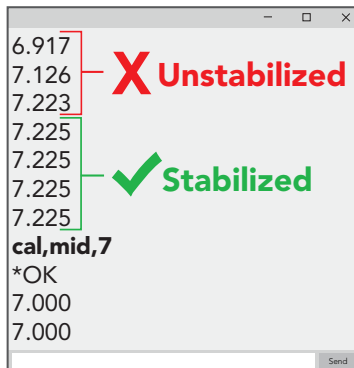
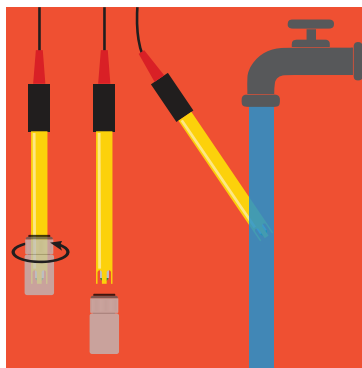

✓ Mid point calibrated

2. Low point calibration

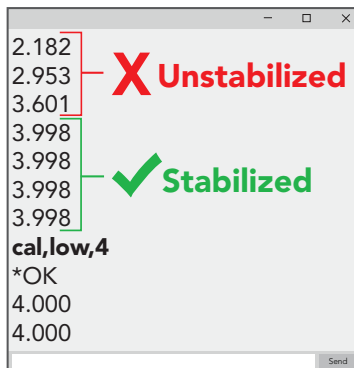
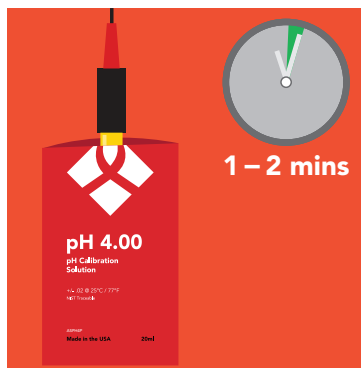
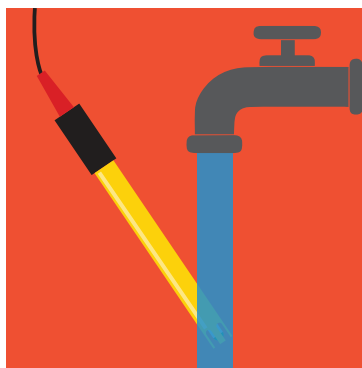

✓ Low point calibrated

3. High point calibration

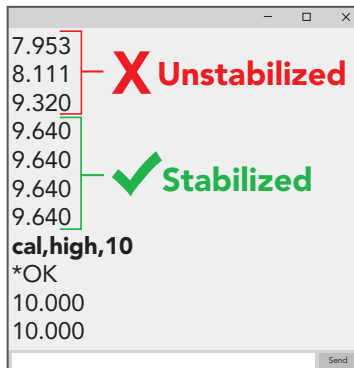
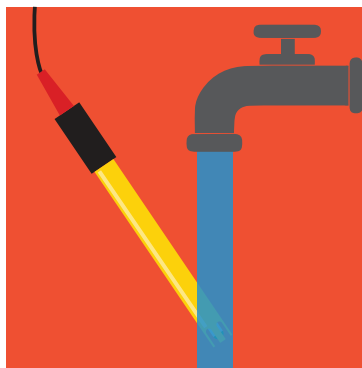

✓ High point calibrated

Optional steps:

Confirm your calibration accuracy using the slope command.
Recalibre a single point if required.

Understanding pH slope

The slope function is a powerful tool used to verify calibration and determine the overall health of a pH probe. By evaluating the slope of a pH probe's response curve, you can determine how well a pH probe was calibrated or when that probe is reaching end of life.

Slope and calibration are directly related. The slope is updated when a calibration command is given. The slope does not update automatically.

Generally speaking, all pH probes behave the same way. This means a probe's response to calibration can be compared to a simulated pH probe that is mathematically perfect in all ways.



The slope is broken into three sections; acid, base, and neutral. Each section is evaluated separately.

- Acid (pH 1–6.9)
- Base (pH 7.1–14)
- Neutral (pH 7)

An uncalibrated pH probe will have a mathematically perfect slope. Because no pH probe is mathematically perfect, the slope can be used to determine if the pH was calibrated.

Uncalibrated slope: 100, 100, 0 (acid, base, neutral)
% % mV

The first two numbers are percentages, and the third is millivolts. The slope shows that the probe's response to acid and base is 100% correct, and it detects 0 mV in a pH 7. Because such perfection does not exist in the real world, we know this probe was not calibrated.

Understanding pH slope

pH 7 is the absence of pH; it is not an acid or a base. Therefore it should always be your first calibration point. It is equivalent to the tare function on a scale because it establishes the probe's zero point.

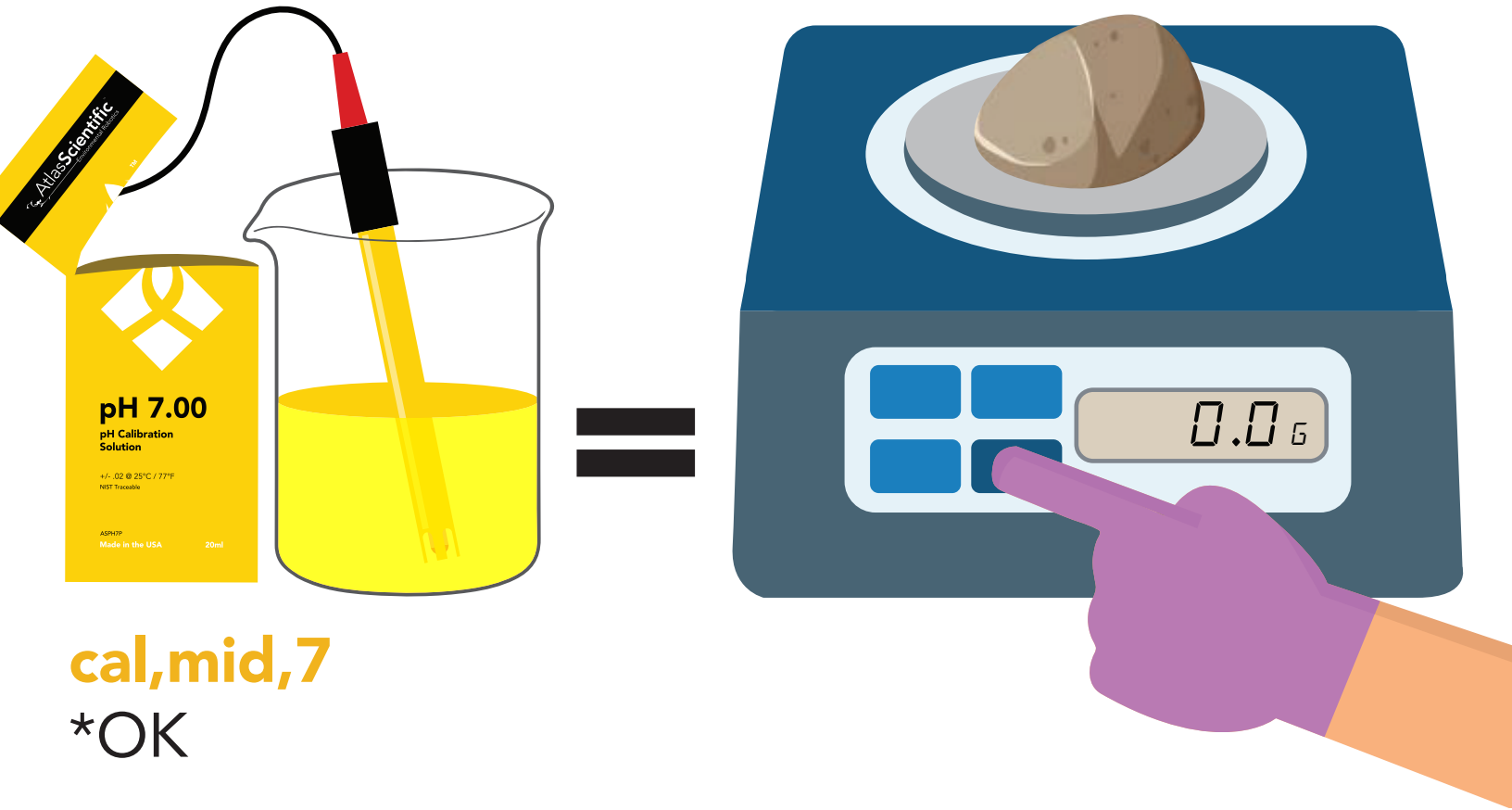

cal,mid,7
***OK**

After pH 7 calibration, use the slope command to see how the probe performed during calibration.

The slope after pH 7 calibration: 100, 100, -1.2

Here we see the probe reads -1.2mV in pH 7. The closer this number is to 0, the better. A new pH probe should give a millivolt offset no greater than -5mV to 5mV. Over time this number's distance to 0 may increase; the larger the number, the lower the accuracy. A reading >10mV will result in noticeable performance issues.

It is important to remember that a high number is not definitive evidence that the probe is inaccurate or malfunctioning. It is very common to see a high number if the calibration solution was contaminated and not actually its stated value.

Understanding pH slope

The next two calibration points (*pH 4* and *pH 10*) report their slope in percentage. A new pH probe should have a slope of $>95\%$.

The slope after pH 4 calibration: 98.2, 100, -1.2

The slope after pH 10 calibration: 98.2, 97.8, -1.2

Tips:

Throughout this explanation, we have looked at the slope after each calibration event. This is unnecessary; in reality, it is best to fully calibrate the probe and look at the slope once calibration has been completed.

To gain a deeper understanding of how slope affects the stability and accuracy of a pH probe, intentionally miscalibrate the probe and see how it affects the slope.

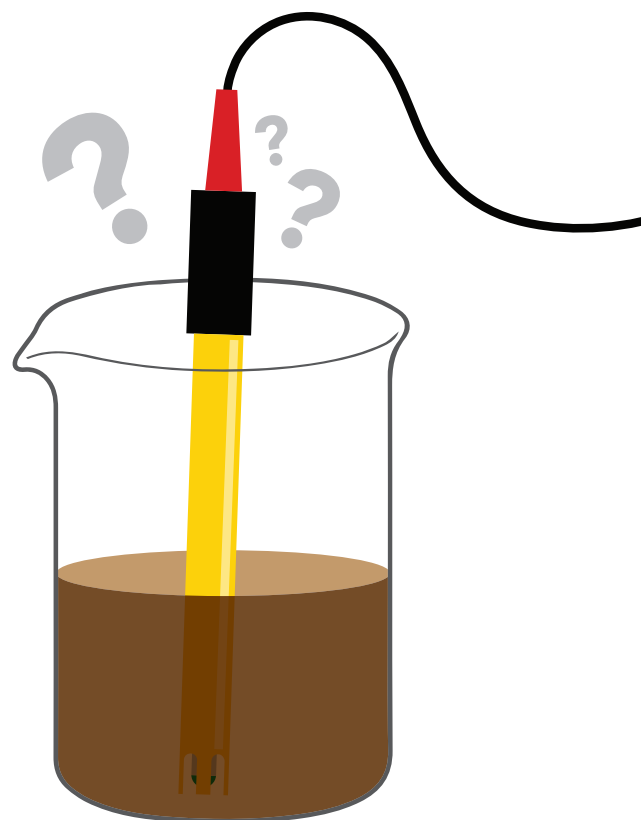

Soldering

Do not directly solder an EZO circuit to your PCB. If something goes wrong during the soldering process it may become impossible to correct the problem. It is simply not worth the risk.

Instead, solder female header pins to your PCB and place the EZO device in the female headers.

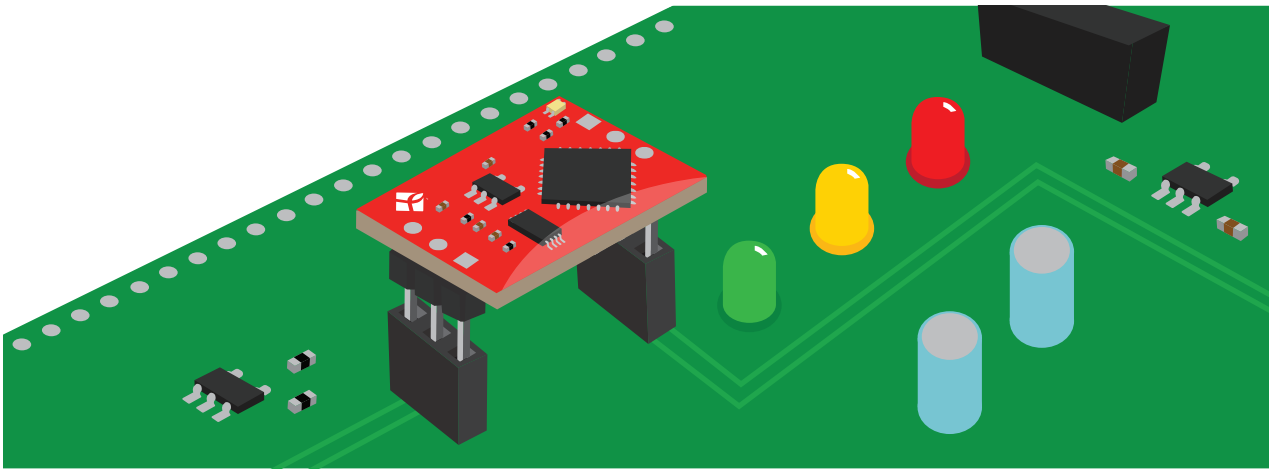

Avoid using rosin core solder.
Use as little flux as possible.

Flux residue will severely affect your readings. Any Flux residue that comes in contact with the PRB pins or your probes connector will cause a “flux short”.

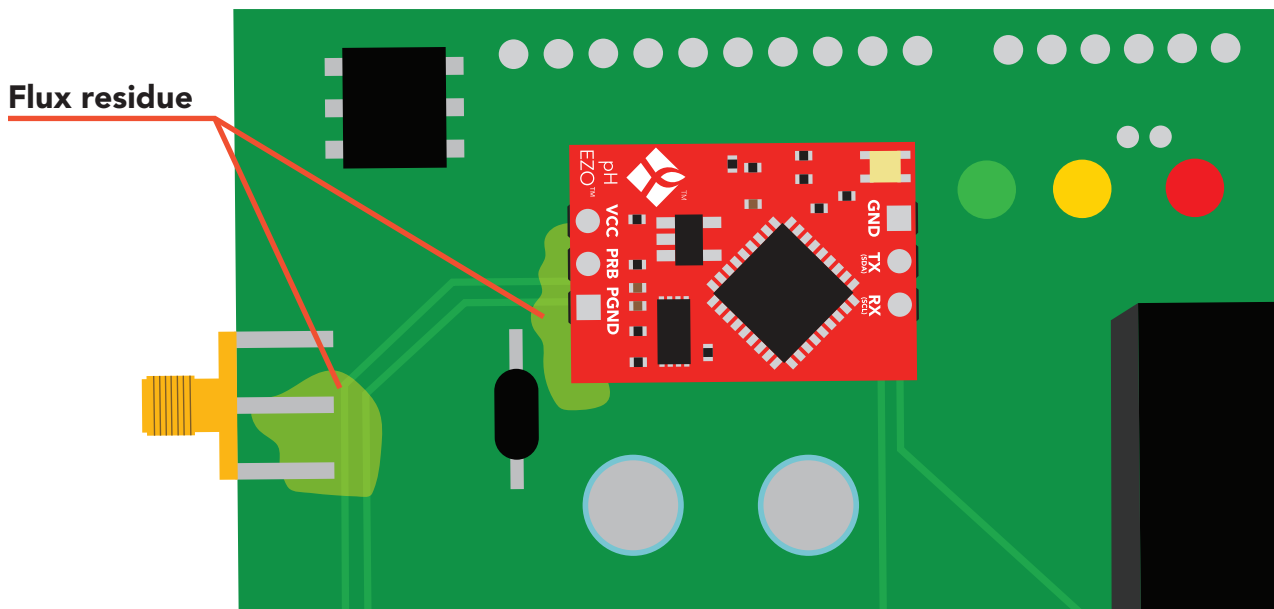

You **MUST** remove all the flux residue from your PCB after soldering.

Soldering

Removing flux residue can be done with commercially available products such as flux off or you can use alcohol and a tooth brush.



Remove EZO Circuit and soak in alcohol for 10 mins.

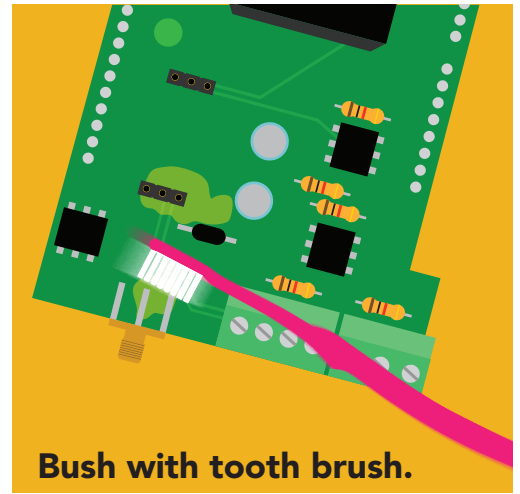

Bush with tooth brush.



Soak in alcohol for 5 mins.



Let it dry in the air.

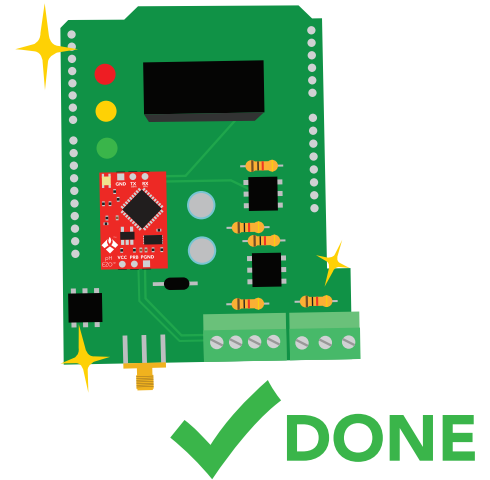

What does a flux short look like?

- 1: Readings move slowly and take several minutes to reach the correct value.
- 2: Readings are pinned to 0, 7 or 14.

EZO™ circuit footprint

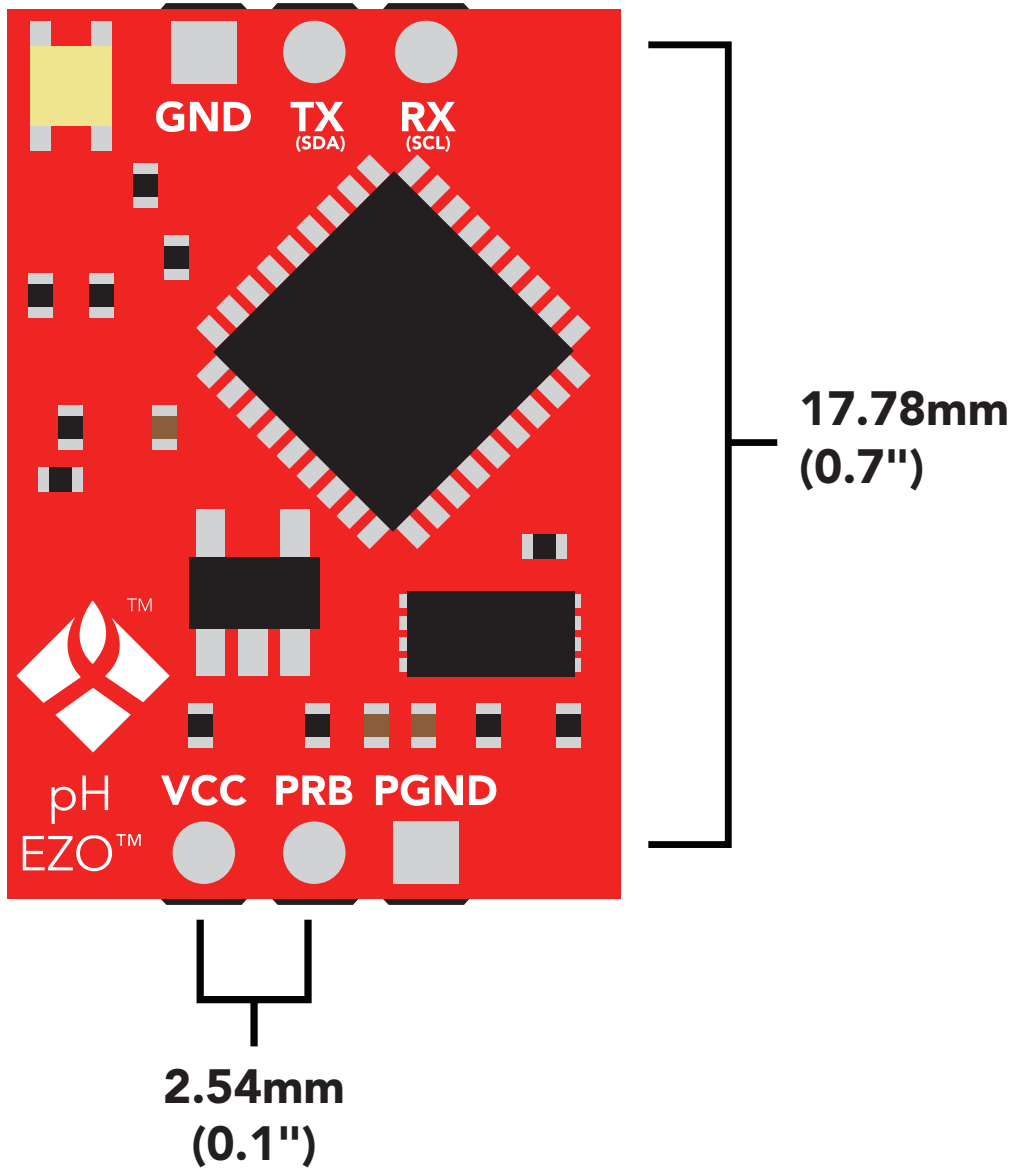

1 In your CAD software place a 8 position header.

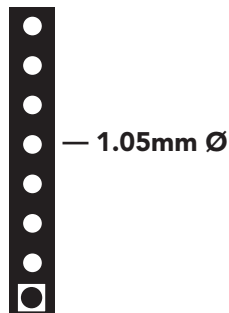

2 Place a 3 position header at both top and bottom of the 8 position.

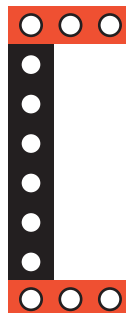

3 Delete the 8 position header. The two 3 position headers are now 17.78mm (0.7") apart from each other.

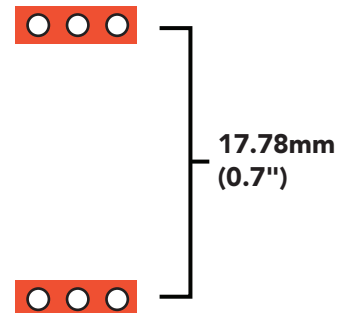

Datasheet change log

Datasheet V 6.1

Revised electrical isolation section on page 7.

Datasheet V 6.0

Revised entire document.

Datasheet V 5.9

Revised naming device info on pages 32 & 58.

Datasheet V 5.8

Revised calibration info and art on pages 11 & 12.

Datasheet V 5.7

Added new command:

"Extended pH Scale" pages 30 (UART) & 56 (I²C).

Datasheet V 5.6

Revised information on the slope command found on pages 29 & 54.

Datasheet V 5.5

Revised artwork within datasheet.

Datasheet V 5.4

Moved the Default state to pg 14.

Datasheet V 5.3

Revised response for the sleep command in UART mode on pg 35.

Datasheet V 5.2

Revised calibration theory on page 11, and added more information on the Export calibration and Import calibration commands.

Datasheet V 5.1

Revised isolation schematic on pg 10.

Datasheet V 5.0

Added more information about temperature compensation on pages 29 & 53.

Datasheet V 4.9

Changed "Max rate" to "Response time" on cover page.

Datasheet V 4.8

Added new command:

"RT,n" for Temperature compensation located on pages 29 (UART) & 53 (I²C).

Added firmware information to Firmware update list.

Datasheet V 4.7

Removed note from certain commands about firmware version.

Datasheet V 4.6

Added information to calibration theory on pg 7.

Datasheet V 4.5

Revised definition of response codes on pg 44.

Datasheet V 4.4

Added resolution range to cover page.

Datasheet V 4.3

Revised isolation information on pg 9.

Datasheet V 4.2

Revised Plock pages to show default value.

Datasheet V 4.1

Added new commands:

"Find" pages 23 (UART) & 46 (I²C).

"Export/Import calibration" pages 27 (UART) & 49 (I²C).

Added new feature to continuous mode "C,n" pg 24.

Datasheet V 4.0

Added accuracy range on cover page, and revised isolation info on pg. 10.

Datasheet V 3.9

Revised calibration theory on pg. 7.

Datasheet V 3.8

Revised entire datasheet.

Firmware updates

V1.5 – Baud rate change (Nov 6, 2014)

- Change default baud rate to 9600

V1.6 – I²C bug (Dec 1, 2014)

- Fixed I²C bug where the circuit may inappropriately respond when other I²C devices are connected.

V1.7 – Factory (April 14, 2015)

- Changed "X" command to "Factory"

V1.95 – Plock (March 31, 2016)

- Added protocol lock feature "Plock"

V1.96 – EEPROM (April 26, 2016)

- Fixed bug where EEPROM would get erased if the circuit lost power 900ms into startup

V1.97 – EEPROM (Oct 10, 2016)

- Added the option to save and load calibration.

V1.98 – EEPROM (Nov 14, 2016)

- Fixed bug during calibration process.

V2.10 – (May 9, 2017)

- Added "Find" command.
- Added "Export/import" command.
- Modified continuous mode to be able to send readings every "n" seconds.

V2.11 – (June 12, 2017)

- Fixed "I" command to return "pH" instead of "PH".

V2.12 – (April 16, 2018)

- Fixed "cal,clear" was not clearing stored calibration in EEPROM.
- Added "RT" command to Temperature compensation.

V2.13 – (June 25, 2019)

- Added calibration offset to slope.
- Added calibration with temperature compensation.

V2.14 – (June 10, 2020)

- Added extended pH scale.

v2.15 – (Nov 3, 2021)

- Internal update for new part compatibility.

v2.16 – (Nov 19, 2021)

- Fixed bug in I2C mode with timing and sleep mode.

Warranty

Atlas Scientific™ Warranties the EZO™ class pH circuit to be free of defect during the debugging phase of device implementation, or 30 days after receiving the EZO™ class pH circuit (which ever comes first).

The debugging phase

The debugging phase as defined by Atlas Scientific™ is the time period when the EZO™ class pH circuit is inserted into a bread board, or shield. If the EZO™ class pH circuit is being debugged in a bread board, the bread board must be devoid of other components. If the EZO™ class pH circuit is being connected to a microcontroller, the microcontroller must be running code that has been designed to drive the EZO™ class pH circuit exclusively and output the EZO™ class pH circuit data as a serial string.

It is important for the embedded systems engineer to keep in mind that the following activities will void the EZO™ class pH circuit warranty:

- Soldering any part of the EZO™ class pH circuit.
- Running any code, that does not exclusively drive the EZO™ class pH circuit and output its data in a serial string.
- Embedding the EZO™ class pH circuit into a custom made device.
- Removing any potting compound.

Reasoning behind this warranty

Because Atlas Scientific™ does not sell consumer electronics; once the device has been embedded into a custom made system, Atlas Scientific™ cannot possibly warranty the EZO™ class pH circuit, against the thousands of possible variables that may cause the EZO™ class pH circuit to no longer function properly.

Please keep this in mind:

- 1. All Atlas Scientific™ devices have been designed to be embedded into a custom made system by you, the embedded systems engineer.**
- 2. All Atlas Scientific™ devices have been designed to run indefinitely without failure in the field.**
- 3. All Atlas Scientific™ devices can be soldered into place, however you do so at your own risk.**

Atlas Scientific™ is simply stating that once the device is being used in your application, Atlas Scientific™ can no longer take responsibility for the EZO™ class pH circuits continued operation. This is because that would be equivalent to Atlas Scientific™ taking responsibility over the correct operation of your entire device.