

KEMET Part Number: ESY277M063AL3AA
(SY277M063AL3AAPLP)

Capacitor, aluminum, 270 uF, +/-20% Tol, -40/+105C, 63VDC@105° C

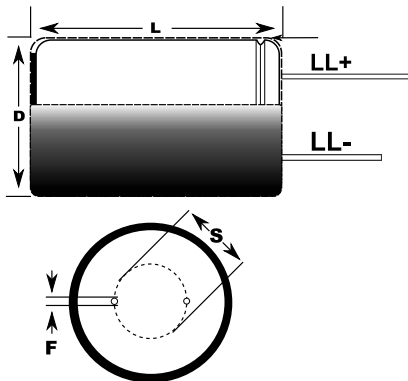

Dimensions (mm)		
Symbol	Dimension	Tolerance
D	13	+/-0.5
L	20	+2
S	5	+/-0.5
LLPos	20	MIN
LLNeg	15	MIN
F	0.6	

Packaging Specifications	
Package Kind:	Bulk
Package Quantity:	2000

General Information	
Supplier:	KEMET
Part Type Description:	Radial Cylindrical Aluminum Electrolytic
Style:	Radial Cylindrical
Lead Type:	Straight

Specifications	
Capacitance:	270 uF
Tolerance:	+/-20%
Rated Temperature:	105° C
Voltage @ rated temp:	63VDC
VDC Surge:	79VDC
Life @ rated temp:	5000 Hrs
RoHS:	Yes
Low Z/ESR:	Yes
Temperature Range:	-40/+105C
Leakage Condition:	2min/20c
Dissipation Factor:	9%
Impedance @ 100kHz:	60 mOhm
Impedance Ratio -25C:	2.0
Impedance Ratio -40C:	3.0
Ripple 120Hz @ rated temp:	1.05 A
Ripple 1kHz @ rated temp:	1.275 A
Ripple 10kHz @ rated temp:	1.425 A
Ripple 100kHz @ rated temp:	1.5 A