

MOSFET – Power, N-Channel, UltraFET

55 V, 75 A, 7 mΩ

FDH5500-F085

Features

- Typ $R_{DS(on)} = 5.2\text{ m}\Omega$ at $V_{GS} = 10\text{ V}$, $I_D = 75\text{ A}$
- Typ $Q_{g(10)} = 118\text{ nC}$ at $V_{GS} = 10\text{ V}$
- Simulation Models
–Temperature Compensated PSpice™ and Saber® Models
- Peak Current vs Pulse Width Curve
- UIS Rating Curve
- AEC-Q101 Qualified and PPAP Capable
- This Device is Pb-Free and is RoHS Compliant

Applications

- DC Linear Mode Control
- Solenoid and Motor Control
- Switching Regulators
- Automotive Systems



ON Semiconductor®

www.onsemi.com

V_{DSS}	$R_{DS(ON)}\text{ MAX}$	$I_D\text{ MAX}$
55 V	7 mΩ	75 A

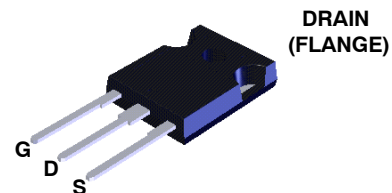
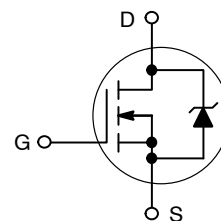

JEDEC TO-247
CASE 340CK

MARKING DIAGRAM

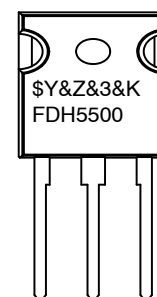

\$Y	= ON Semiconductor Logo
&Z	= Assembly Plant Code
&3	= Data Code (Year & Week)
&K	= Lot
FDH5500	= Specific Device Code

ORDERING INFORMATION

See detailed ordering and shipping information on page 2 of this data sheet.

FDH5500–F085

MOSFET MAXIMUM RATINGS ($T_C = 25^\circ\text{C}$, Unless otherwise noted)

Symbol	Parameter	Value	Unit	
V_{DSS}	Drain to Source Voltage (Note 1)	55	V	
V_{DGR}	Gate to Gate Voltage ($R_{GS} = 20\text{ k}\Omega$) (Note 1)	55	V	
V_{GS}	Gate to Source Voltage	± 20	V	
I_D	Drain Current Continuous ($T_C < 135^\circ\text{C}$, $V_{GS} = 10\text{ V}$)	75	A	
	Pulsed	Figure 4		
E_{AS}	Single Pulse Avalanche Energy (Note 2)	864	mJ	
P_D	Power Dissipation	($T_C = 25^\circ\text{C}$)	375	W
		- Derate Above 25°C	2.5	W/ $^\circ\text{C}$
T_J, T_{STG}	Operating and Storage Temperature	-55 to $+175$	$^\circ\text{C}$	
T_L	Max. Lead Temp. for Soldering (at 1.6 mm from case for 10 sec)	300	$^\circ\text{C}$	
T_{pkg}	Max. Package Temp. for Soldering (Package Body for 10 sec)	260	$^\circ\text{C}$	

Stresses exceeding those listed in the Maximum Ratings table may damage the device. If any of these limits are exceeded, device functionality should not be assumed, damage may occur and reliability may be affected.

1. Starting $T_J = 25^\circ\text{C}$ to 175°C .
2. Starting $T_J = 25^\circ\text{C}$, $L = 0.48\text{ mH}$, $I_{AS} = 60\text{ A}$

THERMAL CHARACTERISTICS

Symbol	Parameter	Value	Unit
$R_{\theta JC}$	Thermal Resistance Junction to Case	0.4	$^\circ\text{C}/\text{W}$
$R_{\theta JA}$	Thermal Resistance Junction to Ambient TO-247, 1 in^2 copper pad area	30	$^\circ\text{C}/\text{W}$

PACKAGE MARKING AND ORDERING INFORMATION

Device Marking	Device	Package	Reel Size	Tape Width	Quantity
FDH5500	FDH5500–F085	TO-247	Tube	N/A	30 Units

FDH5500-F085

ELECTRICAL CHARACTERISTICS (T_C = 25°C unless otherwise noted)

Symbol	Parameter	Test Conditions	Min.	Typ.	Max.	Unit
--------	-----------	-----------------	------	------	------	------

OFF CHARACTERISTICS

B _{VDSS}	Drain to Source Breakdown Voltage	I _D = 250 μA, V _{GS} = 0 V	55			V
I _{DSS}	Zero Gate Voltage Drain Current	V _{DS} = 50 V, V _{GS} = 0 V, V _{DS} = 45 V			1	μA
		V _{DS} = 50 V, V _{GS} = 0 V, V _{DS} = 45 V, T _C = 150°C			250	
I _{GSS}	Gate to Source Leakage Current	V _{GS} = ±20 V			±100	nA

ON CHARACTERISTICS

V _{GS(TH)}	Gate to Source Threshold Voltage	V _{GS} = V _{DS} , I _D = 250 μA	2.0	2.9	4.0	V
R _{DS(ON)}	Drain to Source On Resistance	I _D = 75 A, V _{GS} = 10 V		5.2	7	mΩ

DYNAMIC CHARACTERISTICS

C _{ISS}	Input Capacitance	V _{DS} = 25 V, V _{GS} = 0 V, f = 1 MHz		3565		pF
C _{OSS}	Output Capacitance			1310		pF
C _{RSS}	Reverse Transfer Capacitance			395		pF
Q _{g(TOT)}	Total Gate Charge at 20 V	V _{GS} = 0 V to 20 V	V _{DD} = 30 V I _D = 75 A R _L = 0.4 Ω I _g = 1.0 mA	206	268	nC
Q _{g(10)}	Total Gate Charge 10 V	V _{GS} = 0 V to 10 V		118	153	nC
Q _{g(TH)}	Threshold Gate Charge	V _{GS} = 0 V to 2 V		6.2	8.1	nC
Q _{gs}	Gate to Source Gate Charge	V _{DD} = 30 V, I _D = 75 A, R _L = 0.4 Ω, I _g = 1.0 mA		17.8		nC
Q _{gd}	Gate to Drain "Miller" Charge			51		nC

SWITCHING CHARACTERISTICS

t _{on}	Turn-On Time	V _{DD} = 30 V I _D = 75 A R _L = 0.4 Ω V _{GS} = 10 V R _{GS} = 2.5 Ω			185	ns
t _{d(on)}	Turn-On Delay Time			13.7		ns
t _r	Rise Time			102		ns
t _{d(off)}	Turn-Off Delay Time			34		ns
t _f	Fall Time			22		ns
t _{off}	Turn-Off Time				91	ns

DRAIN-SOURCE DIODE CHARACTERISTICS

V _{SD}	Source to Drain Diode Voltage	I _{SD} = 75 A		1	1.25	V
t _{rr}	Reverse Recovery Time	I _F = 75 A, dI _{SD} /dt = 100 A/μs		60	78	ns
Q _{rr}	Reverse Recovery Charge			77	100	nC

Product parametric performance is indicated in the Electrical Characteristics for the listed test conditions, unless otherwise noted. Product performance may not be indicated by the Electrical Characteristics if operated under different conditions.

FDH5500-F085

TYPICAL CHARACTERISTICS

($T_C = 25^\circ\text{C}$ unless otherwise noted)

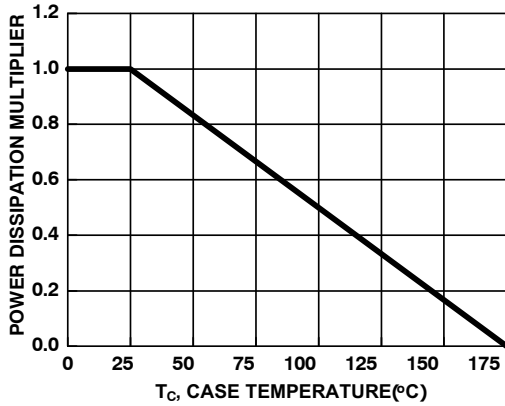

Figure 1. Normalized Power Dissipation vs. Case Temperature

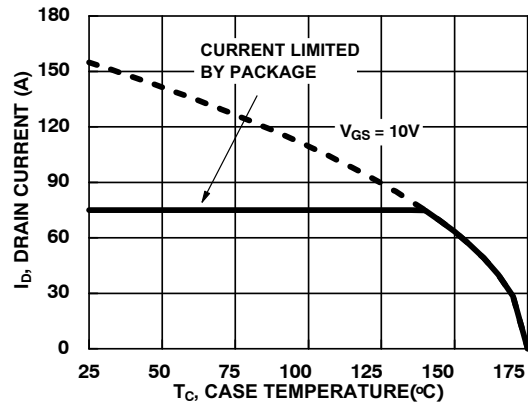

Figure 2. Maximum Continuous Drain Current vs. Case Temperature

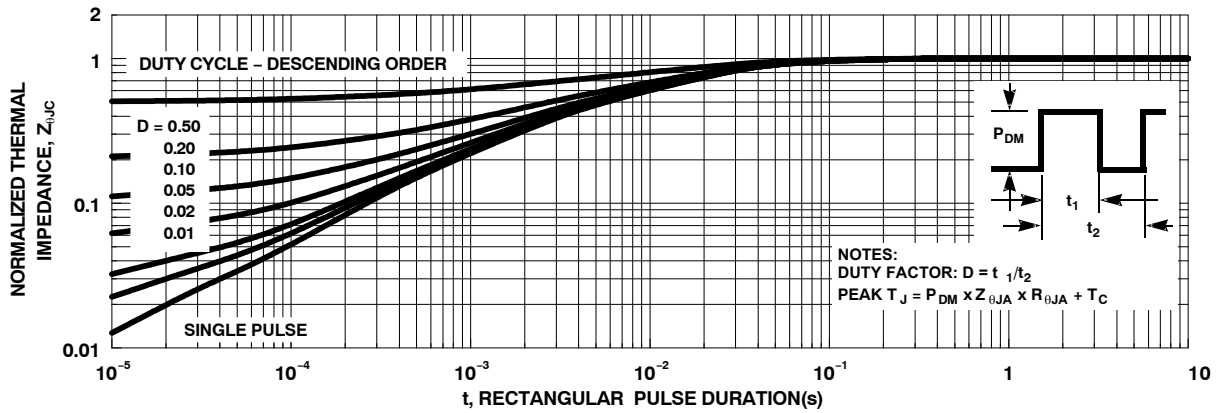

Figure 3. Normalized Maximum Transient Thermal Impedance

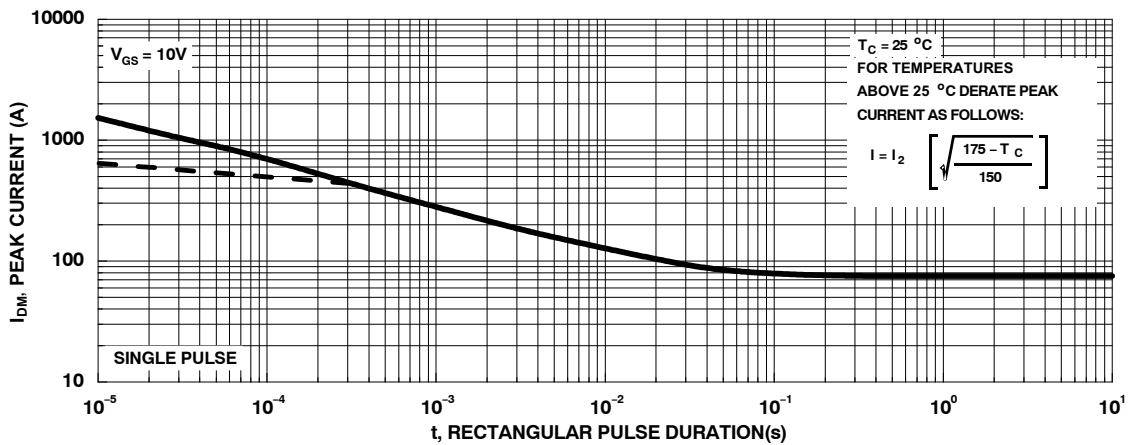

Figure 4. Peak Current Capability

TYPICAL CHARACTERISTICS (Continued)

($T_C = 25^\circ\text{C}$ unless otherwise noted)

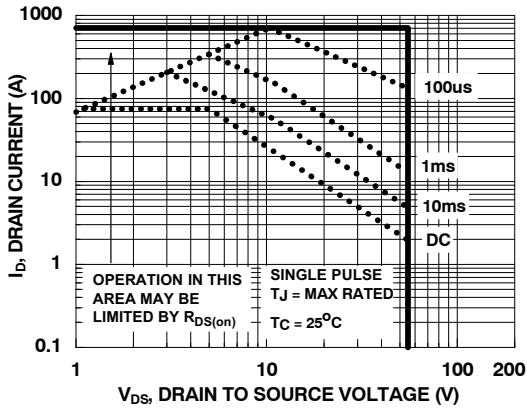

Figure 5. Forward Bias Safe Operating Area

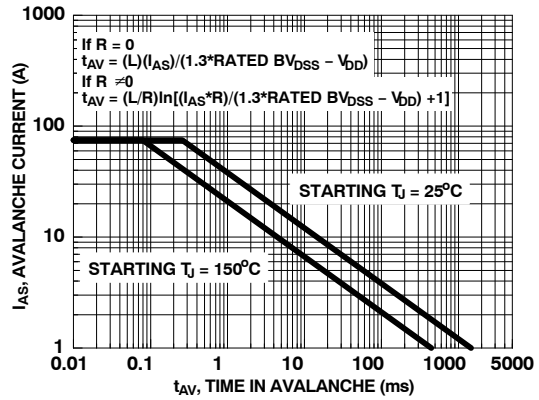

Figure 6. Unclamped Inductive Switching Capability

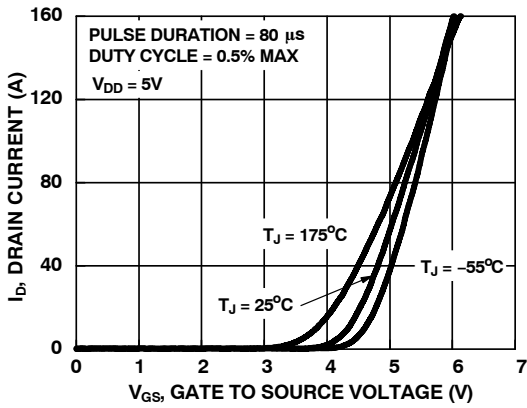

Figure 7. Transfer Characteristics

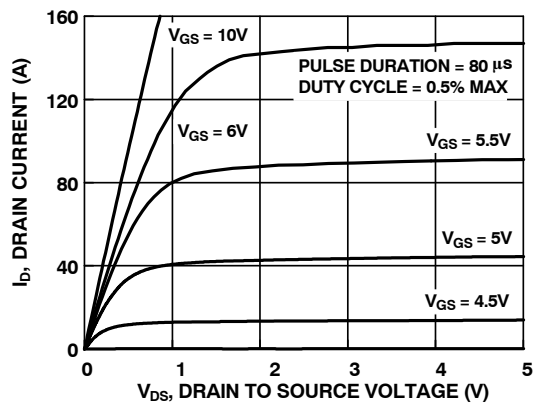

Figure 8. Saturation Characteristics

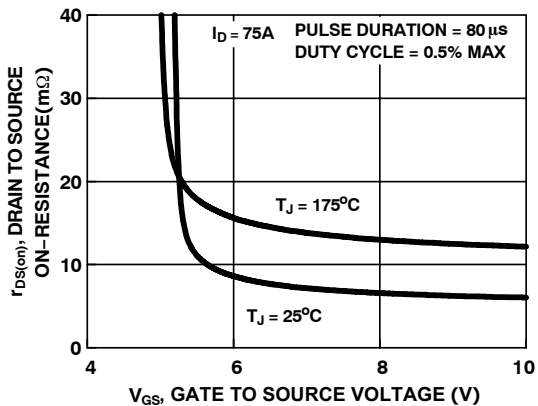

Figure 9. Drain to Source On Resistance Variation vs Gate to Source Voltage

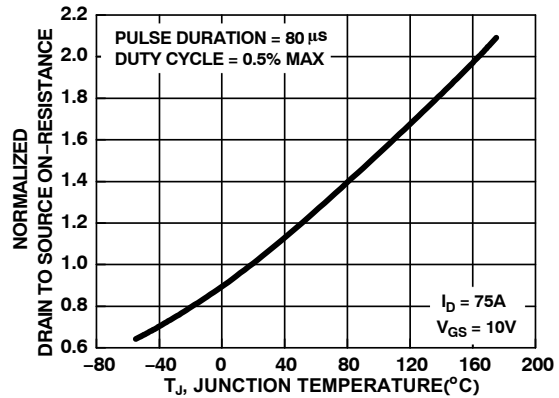

Figure 10. Normalized Drain to Source On Resistance vs. Junction Temperature

TYPICAL CHARACTERISTICS (Continued)

($T_C = 25^\circ\text{C}$ unless otherwise noted)

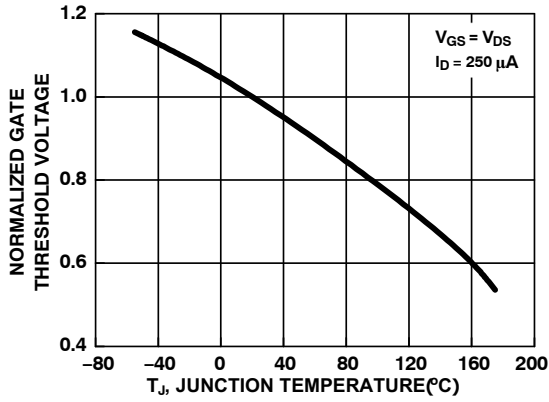

Figure 11. Normalized Gate Threshold Voltage vs. Junction Temperature

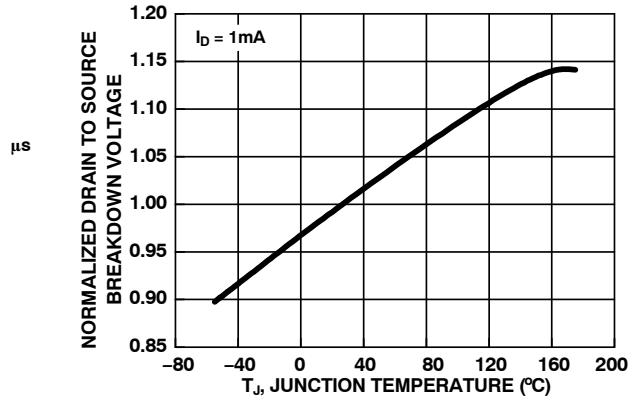

Figure 12. Normalized Drain to Source Breakdown Voltage vs Junction Temperature

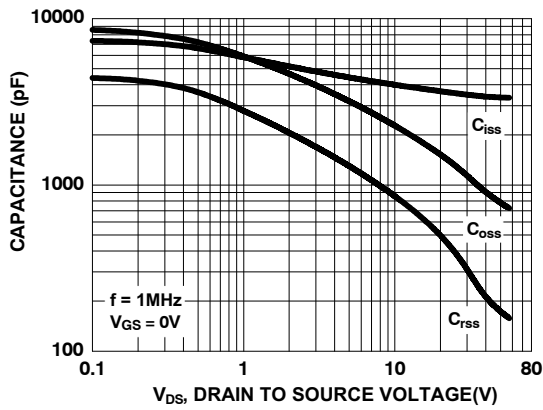

Figure 13. Capacitance vs. Drain to Source Voltage

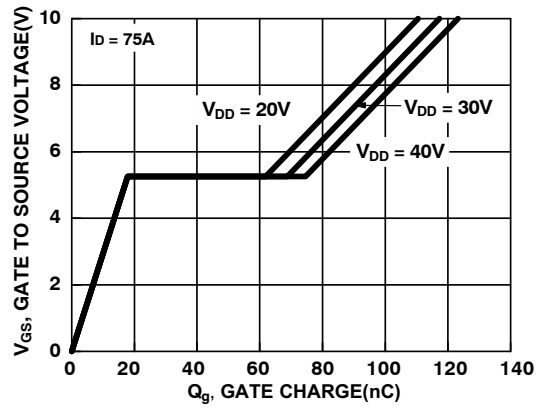

Figure 14. Gate Charge vs. Gate to Source Voltage

PSPIICE is a trademark of MicroSim Corporation.
Saber is a registered trademark of Sabremark Limited Partnership.



TO-247-3LD SHORT LEAD
CASE 340CK
ISSUE A

DATE 31 JAN 2019



NOTES: UNLESS OTHERWISE SPECIFIED.

- A. DIMENSIONS ARE EXCLUSIVE OF BURRS, MOLD FLASH, AND TIE BAR EXTRUSIONS.
- B. ALL DIMENSIONS ARE IN MILLIMETERS.
- C. DRAWING CONFORMS TO ASME Y14.5 - 2009.
- D. DIMENSION A1 TO BE MEASURED IN THE REGION DEFINED BY L1.
- E. LEAD FINISH IS UNCONTROLLED IN THE REGION DEFINED BY L1.

GENERIC MARKING DIAGRAM*

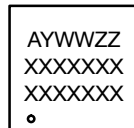

- XXXX = Specific Device Code
- A = Assembly Location
- Y = Year
- WW = Work Week
- ZZ = Assembly Lot Code

*This information is generic. Please refer to device data sheet for actual part marking. Pb-Free indicator, "G" or microdot "•", may or may not be present. Some products may not follow the Generic Marking.

DIM	MILLIMETERS		
	MIN	NOM	MAX
A	4.58	4.70	4.82
A1	2.20	2.40	2.60
A2	1.40	1.50	1.60
b	1.17	1.26	1.35
b2	1.53	1.65	1.77
b4	2.42	2.54	2.66
c	0.51	0.61	0.71
D	20.32	20.57	20.82
D1	13.08	~	~
D2	0.51	0.93	1.35
E	15.37	15.62	15.87
E1	12.81	~	~
E2	4.96	5.08	5.20
e	~	5.56	~
L	15.75	16.00	16.25
L1	3.69	3.81	3.93
ØP	3.51	3.58	3.65
ØP1	6.60	6.80	7.00
Q	5.34	5.46	5.58
S	5.34	5.46	5.58

DOCUMENT NUMBER:	98AON13851G	Electronic versions are uncontrolled except when accessed directly from the Document Repository. Printed versions are uncontrolled except when stamped "CONTROLLED COPY" in red.
DESCRIPTION:	TO-247-3LD SHORT LEAD	PAGE 1 OF 1

ON Semiconductor and are trademarks of Semiconductor Components Industries, LLC dba ON Semiconductor or its subsidiaries in the United States and/or other countries. ON Semiconductor reserves the right to make changes without further notice to any products herein. ON Semiconductor makes no warranty, representation or guarantee regarding the suitability of its products for any particular purpose, nor does ON Semiconductor assume any liability arising out of the application or use of any product or circuit, and specifically disclaims any and all liability, including without limitation special, consequential or incidental damages. ON Semiconductor does not convey any license under its patent rights nor the rights of others.

onsemi, **Onsemi**, and other names, marks, and brands are registered and/or common law trademarks of Semiconductor Components Industries, LLC dba "**onsemi**" or its affiliates and/or subsidiaries in the United States and/or other countries. **onsemi** owns the rights to a number of patents, trademarks, copyrights, trade secrets, and other intellectual property. A listing of **onsemi**'s product/patent coverage may be accessed at www.onsemi.com/site/pdf/Patent-Marking.pdf. **onsemi** reserves the right to make changes at any time to any products or information herein, without notice. The information herein is provided "as-is" and **onsemi** makes no warranty, representation or guarantee regarding the accuracy of the information, product features, availability, functionality, or suitability of its products for any particular purpose, nor does **onsemi** assume any liability arising out of the application or use of any product or circuit, and specifically disclaims any and all liability, including without limitation special, consequential or incidental damages. Buyer is responsible for its products and applications using **onsemi** products, including compliance with all laws, regulations and safety requirements or standards, regardless of any support or applications information provided by **onsemi**. "Typical" parameters which may be provided in **onsemi** data sheets and/or specifications can and do vary in different applications and actual performance may vary over time. All operating parameters, including "Typicals" must be validated for each customer application by customer's technical experts. **onsemi** does not convey any license under any of its intellectual property rights nor the rights of others. **onsemi** products are not designed, intended, or authorized for use as a critical component in life support systems or any FDA Class 3 medical devices or medical devices with a same or similar classification in a foreign jurisdiction or any devices intended for implantation in the human body. Should Buyer purchase or use **onsemi** products for any such unintended or unauthorized application, Buyer shall indemnify and hold **onsemi** and its officers, employees, subsidiaries, affiliates, and distributors harmless against all claims, costs, damages, and expenses, and reasonable attorney fees arising out of, directly or indirectly, any claim of personal injury or death associated with such unintended or unauthorized use, even if such claim alleges that **onsemi** was negligent regarding the design or manufacture of the part. **onsemi** is an Equal Opportunity/Affirmative Action Employer. This literature is subject to all applicable copyright laws and is not for resale in any manner.

ADDITIONAL INFORMATION

TECHNICAL PUBLICATIONS:

Technical Library: www.onsemi.com/design/resources/technical-documentation
onsemi Website: www.onsemi.com

ONLINE SUPPORT: www.onsemi.com/support

For additional information, please contact your local Sales Representative at www.onsemi.com/support/sales