

Pad Cutters, Insertion Tools



P138A
Wooden Handle type

Pad Cutters



Shank Only
P138C

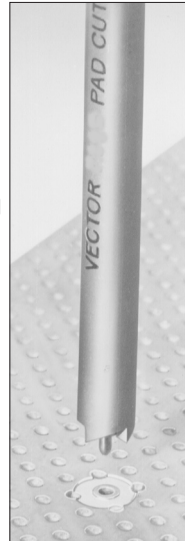
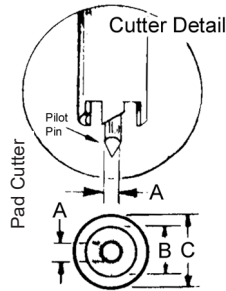

Shows pad removal & pad cutter

Vector Pad Cutters provide an effective method for creating isolated solder pads around holes in copper clad boards. Pilot pin enters hole and rotates, creating a clearance area around the solder pad. Available for boards with .042" diameter holes. Also available without handles for use with manual or power drills.

Part No.	Holder Type	A	B	C	Shank	Use with Vectorbord®
P138A	Handle/Shank	.040"	.086"	.125"	.125"	Pattern P, .042: holes
P138C	Shank Only	.040"	.086"	.125"	.125"	Pattern P, .042: holes

Hand Insertion Tools for Push-In Terminals

Part No	Terminal P/N	Holder Type
A13	T44	Shank with removable rubber handle
A13-1	T68	Shank with removable rubber handle
P91A	T28	Wooden Handle
P156	T49	Wooden Handle
P133A	T46 series & K24 - K31	Shank with removable rubber handle
P134	K36	Wooden Handle
P149A	T42-1	Wooden Handle
P149	T42-1	Shank with removable rubber handle

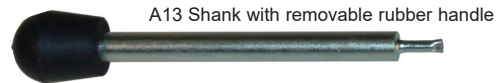
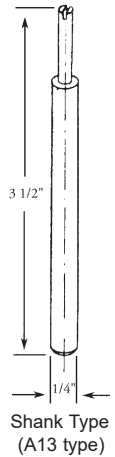

A13 Shank with removable rubber handle



P149 Shank with removable rubber handle



P149A - Wooden Handle Type

T107

Bus Strips

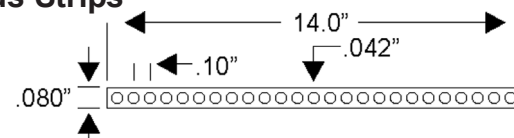

- Flat cold-drawn flat copper wire, 0.017" thick (+/-0.003")
- 0.080"W with 0.042" diameter holes on 0.100" centers
- Hot 100% Tin dipped, fully RoHS compliant
- Compatible with most Vectorbord® hole patterns



Part No.	Pkg Qty
T107/C	100
T107/10	10

HA14

Pull Type Ejector Handle

- Extraction/insertion handles
- Mounts on front edge of Plugbord™ with single screw or roll-pin
- Plastic (FE4)

Part No.	Package Quantity
HA14	4
HA14/C	100

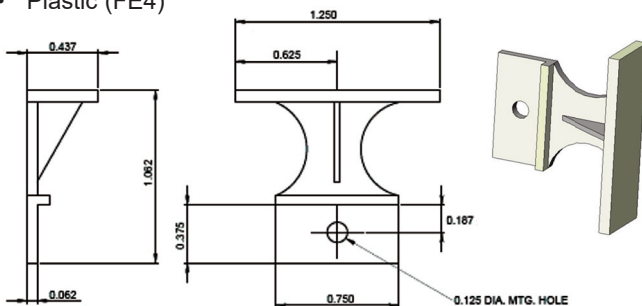

HA9

Rotation Type Ejector Handle

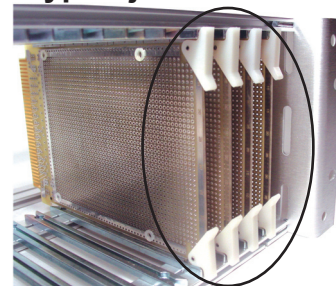

Dimensional information for HA9 is on Page 44

- Card ejector, corner mounting
- Supports up to 40 lbs extraction force
- White nylon, (hardware included)

Part No.	Pkg Qty
HA9/4	4
HA9/C	100

