



**INTEGRATED SYMMETRICAL AND ASYMMETRICAL
BIDIRECTIONAL OVERVOLTAGE PROTECTORS FOR
LUCENT TECHNOLOGIES L7581/2/3 LINE CARD ACCESS SWITCHES**

TISPL758LF3D LCAS Protector

**Symmetrical and Asymmetrical Characteristics for
Optimum Protection of Lucent L7581/2/3 LCAS**

Terminal Pair	V _{DRM} V	V _(BO) V
T-G (SYMMETRICAL)	±105	±130
R-G (ASYMMETRICAL)	+105, -180	+130, -220

Customized versions available

Rated for International Surge Wave Shapes

Wave Shape	Standard	I _{TSP} A
2/10 μs	GR-1089-CORE	175
8/20 μs	ANSI C62.41	120
10/160 μs	FCC Part 68	60
10/700 μs	ITU-T K20/21	50
10/560 μs	FCC Part 68	45
10/1000 μs	GR-1089-CORE	35

- Ion-Implanted Breakdown Region**
- Precise And Stable Voltage**
- Low Voltage Overshoot Under Surge**

Planar Passivated Junctions

- Low Off-State Current.....< ±10 μA**

D Package (Top View)

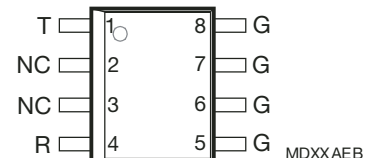

NC - No internal connection

Device Symbol

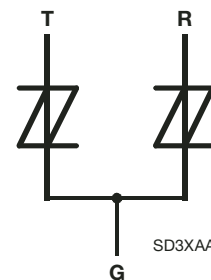

Terminals T, R and G correspond to the alternative line designators of A, B and C



.....UL Recognized Component

How to Order

Device	Carrier	Order As
TISPL758LF3D	Tube	TISPL758LF3D-S
	Taped and reeled	TISPL758LF3DR-S

Description

The TISPL758LF3 is an integrated combination of a symmetrical bidirectional overvoltage protector and an asymmetrical bidirectional overvoltage protector. It is designed to limit the peak voltages on the line terminals of the Lucent Technologies L7581/2/3 LCAS (Line Card Access Switches). An LCAS may also be referred to as a Solid State Relay, SSR, i.e. a replacement of the conventional electro-mechanical relay.

The TISPL758LF3D voltages are chosen to give adequate LCAS protection for all switch conditions. The most potentially stressful condition is low level power cross when the LCAS switches are closed. Under this condition, the TISPL758LF3D limits the voltage and corresponding LCAS dissipation until the LCAS thermal trip operates and opens the switches.

Under open-circuit ringing conditions, the line ring (R) conductor will have high peak voltages. For battery backed ringing, the ring conductor will have a larger peak negative voltage than positive i.e. the peak voltages are asymmetric. An overvoltage protector with a similar voltage asymmetry will give the most effective protection. On a connected line, the tip (T) conductor will have much smaller voltage levels than the open-circuit ring conductor values. Here a symmetrical voltage protector gives adequate protection.



WARNING Cancer and Reproductive Harm
www.P65Warnings.ca.gov

JANUARY 1998 – REVISED JANUARY 2007

*RoHS Directive 2002/95/EC Jan. 27, 2003 including Annex.

Specifications are subject to change without notice. Users should verify actual device performance in their specific applications. The products described herein and this document are subject to specific legal disclaimers as set forth on the last page of this document, and at www.bourns.com/docs/legal/disclaimer.pdf.

TISPL758LF3D LCAS Protector

BOURNS®

Description (Continued)

Overvoltages are normally caused by a.c. power system or lightning flash disturbances which are induced or conducted on to the telephone line. These overvoltages are initially clipped by protector breakdown clamping until the voltage rises to the breakover level, which causes the device to crowbar into a low-voltage on state. This low-voltage on state causes the current resulting from the overvoltage to be safely diverted through the device. For negative surges, the high crowbar holding current helps prevent d.c. latchup with the SLIC current, as the surge current subsides. The TISPL758LF3 is guaranteed to voltage limit and withstand the listed international lightning surges in both polarities.

Support from the Microelectronics Group of Lucent Technologies Inc. is gratefully acknowledged in the definition of the TISPL758LF3D voltage levels and for performing TISPL758LF3D evaluations.

Absolute Maximum Ratings, $T_A = 25\text{ }^\circ\text{C}$ (Unless Otherwise Noted)

Rating		Symbol	Value	Unit
Repetitive peak off-state voltage	R-G terminals	V_{DRM}	-180, +105	V
	T-G terminals		-105, +105	
Non-repetitive peak on-state pulse current (see Notes 1, 2 and 3)	2/10 μs (GR-1089-CORE, 2/10 μs voltage wave shape)	I_{TSP}	175	A
	8/20 μs (ANSI C62.41, 1.2/50 μs voltage wave shape)		120	
	10/160 μs (FCC Part 68, 10/160 μs voltage wave shape)		60	
	5/200 μs (VDE 0433, 2.0 kV, 10/700 μs voltage wave shape)		50	
	0.2/310 μs (I3124, 2.0 kV, 0.5/700 μs voltage wave shape)		50	
	5/310 μs (ITU-T K20/21, 2.0 kV, 10/700 μs voltage wave shape)		50	
	5/310 μs (FTZ R12, 2.0 kV, 10/700 μs voltage wave shape)		50	
	10/560 μs (FCC Part 68, 10/560 μs voltage wave shape)		45	
	10/1000 μs (GR-1089-CORE, 10/1000 μs voltage wave shape)		35	
Non-repetitive peak on-state current (see Notes 1, 2 and 3) full sine wave	50 Hz	I_{TSM}	16	A
	60 Hz		20	
Repetitive peak on-state current, 50/60 Hz, (see Notes 2 and 3)		I_{TSM}	2x1	A
Initial rate of rise of on-state current, Exponential current ramp, Maximum ramp value < 70 A		di_T/dt	150	A/ μs
Junction temperature		T_J	-40 to +150	$^\circ\text{C}$
Storage temperature range		T_{stg}	-40 to +150	$^\circ\text{C}$

- NOTES: 1. Above the maximum specified temperature, derate linearly to zero at 150 $^\circ\text{C}$ lead temperature.
 2. Initially the TISPL758LF3 must be in thermal equilibrium with 0 $^\circ\text{C}$ < T_J < 70 $^\circ\text{C}$.
 3. The surge may be repeated after the TISPL758LF3 returns to its initial conditions.

Recommended Operating Conditions

Component	Min	Typ	Max	Unit
R1 Series Resistor for GR-1089-CORE	first-level surge, operational pass (4.5.7)	20		Ω
R1 Series Resistor for FCC Part 68	10/160 non-operational pass	0		Ω
	10/160 operational pass	18		
	10/560 non-operational pass	0		
	10/560 operational pass	10		
R1 Series Resistor for ITU-T K20/21	10/700, < 2 kV, operational pass	0		Ω
	10/700, 4 kV, operational pass	40		

JANUARY 1998 – REVISED JANUARY 2007

Specifications are subject to change without notice.

Users should verify actual device performance in their specific applications.

The products described herein and this document are subject to specific legal disclaimers as set forth on the last page of this document, and at www.bourns.com/docs/legal/disclaimer.pdf.

TISPL758LF3D LCAS Protector

BOURNS®

Electrical Characteristics for the T-G and R-G Terminal Pairs, $T_J = 25\text{ }^\circ\text{C}$ (Unless Otherwise Noted)

Parameter	Test Conditions	Value			Unit
		Min	Typ	Max	
I_{DRM} Repetitive peak off-state current	$V_D = \pm V_{DRM}$, (See Note 4)			± 10	μA
$V_{(BO)}$ Breakover voltage	$dv/dt = \pm 250\text{ V/ms}$, $R_{SOURCE} = 300\ \Omega$	R-G terminals -220		+130	V
$V_{(BO)}$ Impulse breakover voltage	Rated impulse conditions with operational pass series resistor	T-G terminals -130		+130	V
I_H Holding current	$di/dt = -30\text{ mA/ms}$ $di/dt = +30\text{ mA/ms}$	R-G terminals -240		+140	V
I_D Off-state current	$0 < V_D < \pm 50\text{ V}$, $T_J = 85\text{ }^\circ\text{C}$	T-G terminals -140		+140	V
C_{TG} Off-state capacitance	$f = 100\text{ kHz}$, $V_d = 1\text{ V rms}$ $V_{TG} = -5\text{ V}$, (See Note 5)		+100		mA
C_{RG} Off-state capacitance	$f = 100\text{ kHz}$, $V_d = 1\text{ V rms}$ $V_{TG} = -50\text{ V}$, (See Note 5)		-150		μA
				± 10	μA
			18	36	pF
			10	20	pF

NOTES: 4. Positive and negative values of V_{DRM} are not equal. See ratings table.

5. These capacitance measurements employ a three terminal capacitance bridge incorporating a guard circuit. The third terminal is connected to the guard terminal of the bridge.

Thermal Characteristics

Parameter	Test Conditions	Min	Typ	Max	Unit
$R_{\theta JA}$ Junction to free air thermal resistance				160	$^\circ\text{C/W}$

JANUARY 1998 – REVISED JANUARY 2007

Specifications are subject to change without notice.

Users should verify actual device performance in their specific applications.

The products described herein and this document are subject to specific legal disclaimers as set forth on the last page of this document, and at www.bourns.com/docs/legal/disclaimer.pdf.

Parameter Measurement Information

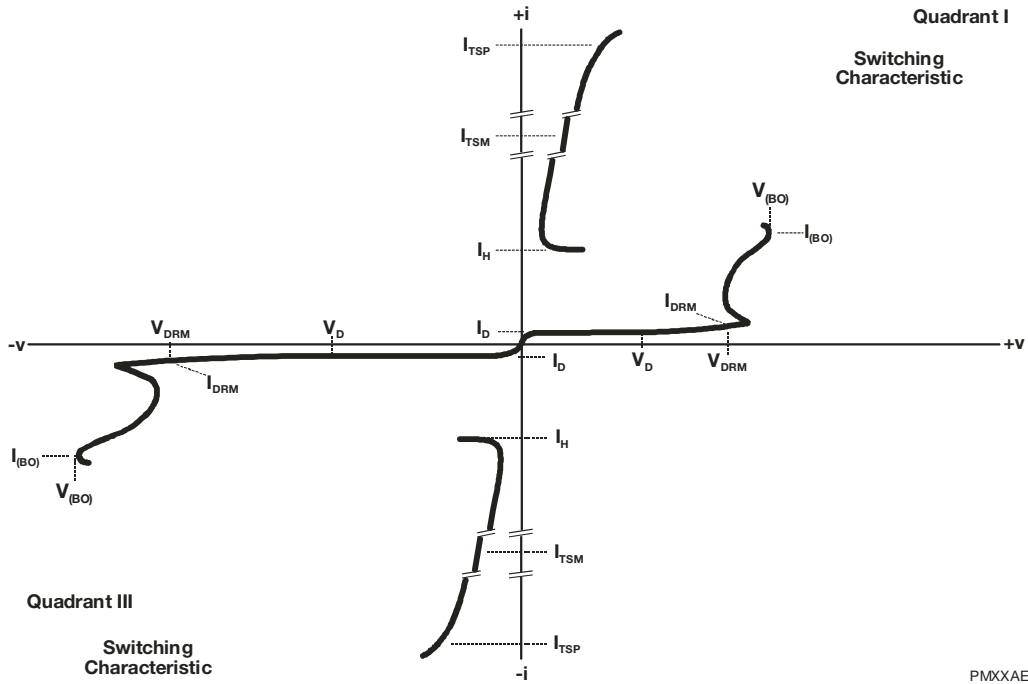

Figure 1. Asymmetrical Voltage-current Characteristic for R-G Terminal Pair

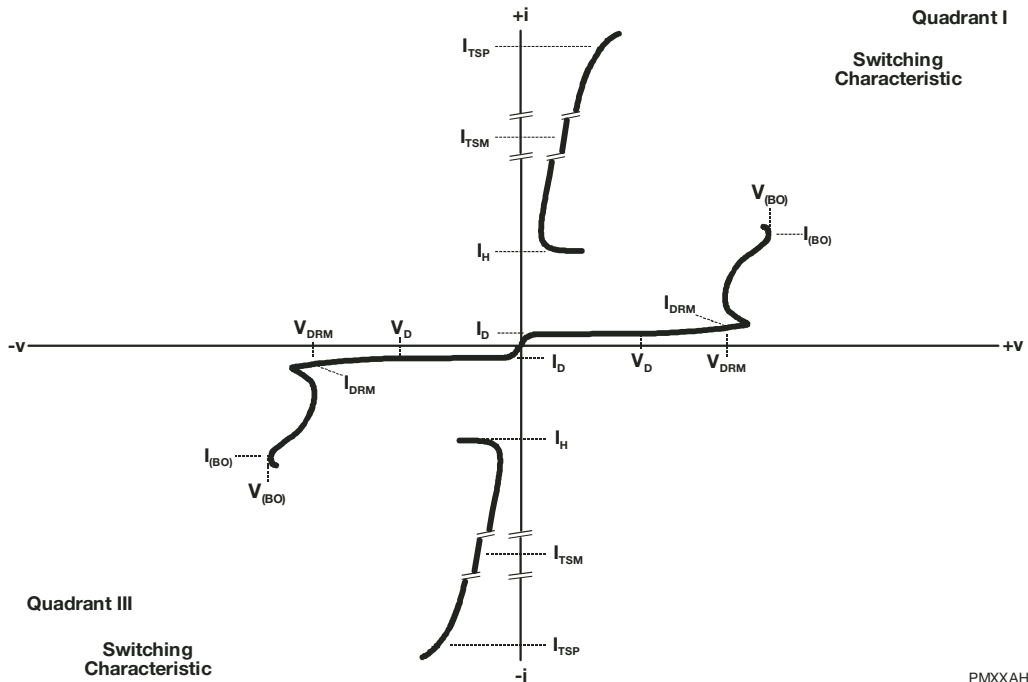

Figure 2. Symmetrical Voltage-current Characteristic for T-G Terminal Pair

Typical Characteristics

**OFF-STATE CURRENT
vs
JUNCTION TEMPERATURE**

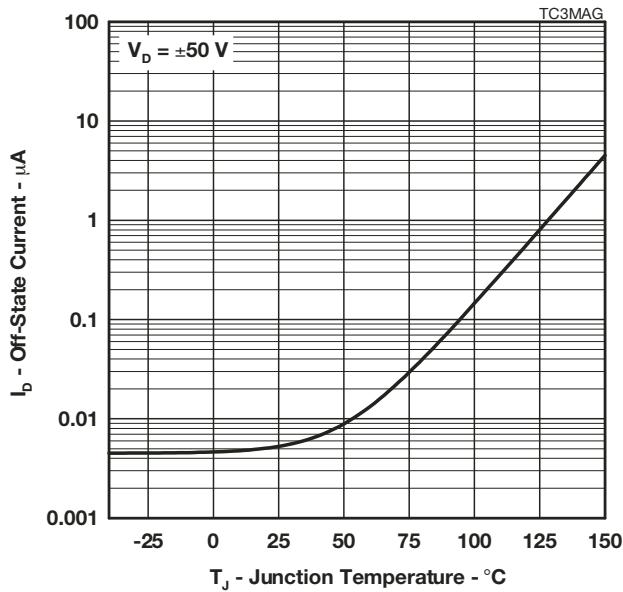

Figure 3.

**NORMALIZED BREAKDOWN VOLTAGES
vs
JUNCTION TEMPERATURE**

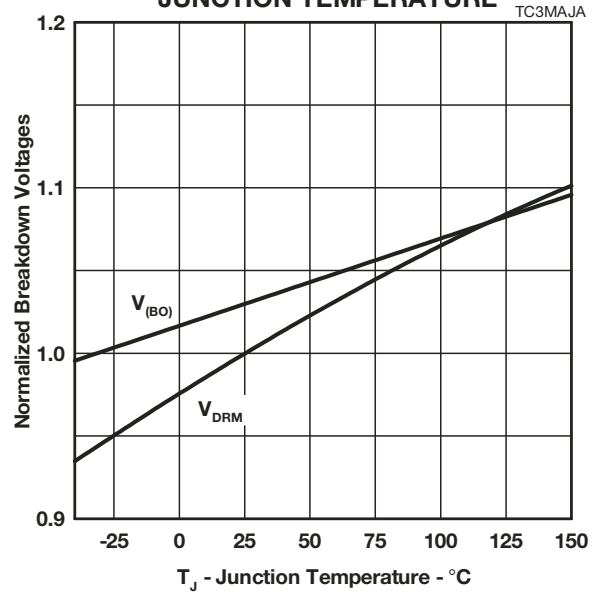

Figure 4.

**NORMALIZED BREAKOVER VOLTAGE
vs
RATE OF RISE OF PRINCIPLE CURRENT**

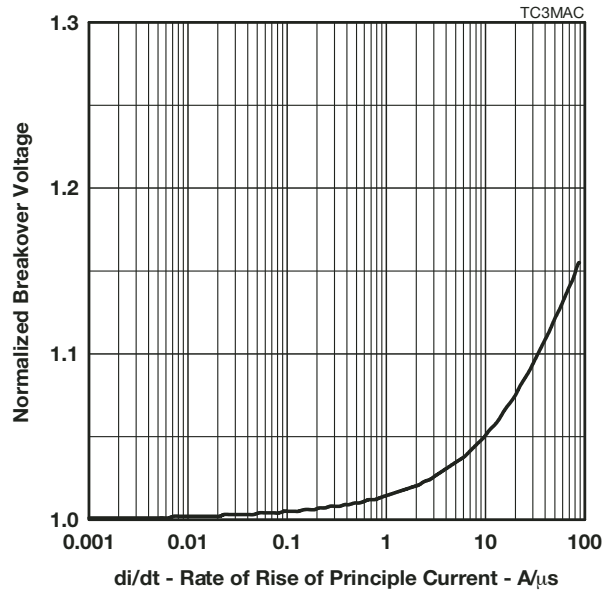

Figure 5.

**NORMALIZED HOLDING CURRENT
vs
JUNCTION TEMPERATURE**

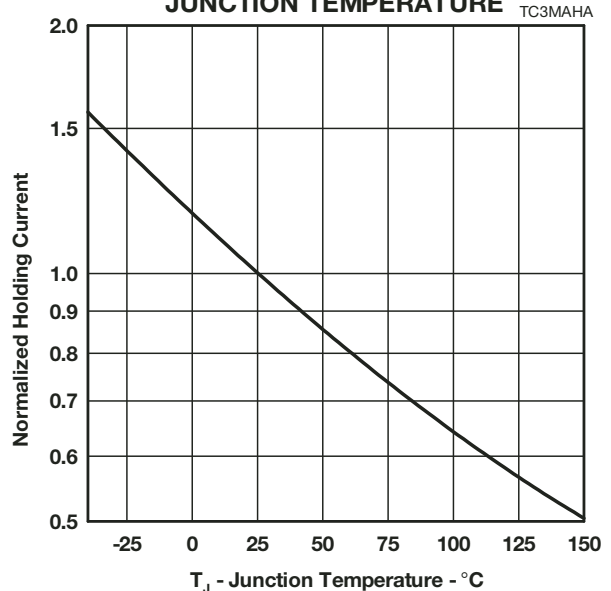

Figure 6.

Applications Information

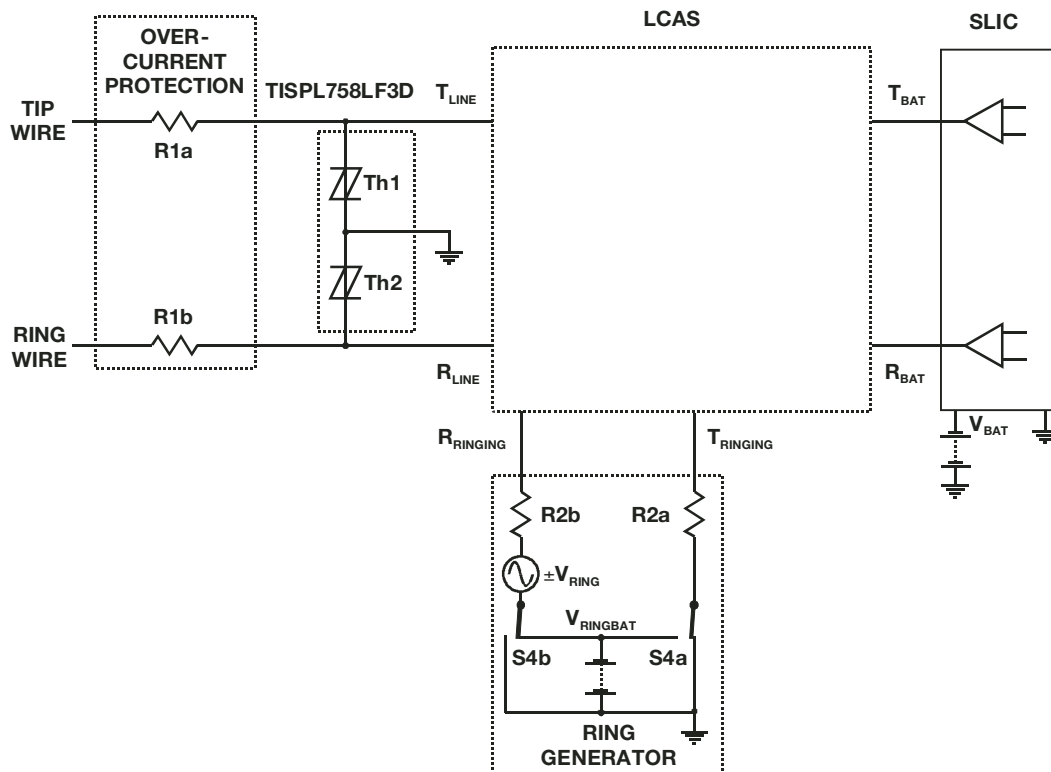

Figure 7. LCAS Protection with a TISPL758LF3D

Bourns Sales Offices

<u>Region</u>	<u>Phone</u>	<u>Fax</u>
The Americas:	+1-951-781-5500	+1-951-781-5700
Europe:	+41-41-7685555	+41-41-7685510
Asia-Pacific:	+886-2-25624117	+886-2-25624116

Technical Assistance

<u>Region</u>	<u>Phone</u>	<u>Fax</u>
The Americas:	+1-951-781-5500	+1-951-781-5700
Europe:	+41-41-7685555	+41-41-7685510
Asia-Pacific:	+886-2-25624117	+886-2-25624116

www.bourns.com

Bourns® products are available through an extensive network of manufacturer's representatives, agents and distributors. To obtain technical applications assistance, a quotation, or to place an order, contact a Bourns representative in your area.



"TISP" is a trademark of Bourns, Ltd., a Bourns Company, and is Registered in U.S. Patent and Trademark Office.

"Bourns" is a registered trademark of Bourns, Inc. in the U.S. and other countries.

COPYRIGHT© 2005, BOURNS, INC. LITHO IN U.S.A. e 07/05 TSP0410

JANUARY 1998 – REVISED JANUARY 2007

Specifications are subject to change without notice.

Users should verify actual device performance in their specific applications.

The products described herein and this document are subject to specific legal disclaimers as set forth on the last page of this document, and at www.bourns.com/docs/legal/disclaimer.pdf.

This legal disclaimer applies to purchasers and users of Bourns® products manufactured by or on behalf of Bourns, Inc. and its affiliates (collectively, “Bourns”).

Unless otherwise expressly indicated in writing, Bourns® products and data sheets relating thereto are subject to change without notice. Users should check for and obtain the latest relevant information and verify that such information is current and complete before placing orders for Bourns® products.

The characteristics and parameters of a Bourns® product set forth in its data sheet are based on laboratory conditions, and statements regarding the suitability of products for certain types of applications are based on Bourns’ knowledge of typical requirements in generic applications. The characteristics and parameters of a Bourns® product in a user application may vary from the data sheet characteristics and parameters due to (i) the combination of the Bourns® product with other components in the user’s application, or (ii) the environment of the user application itself. The characteristics and parameters of a Bourns® product also can and do vary in different applications and actual performance may vary over time. Users should always verify the actual performance of the Bourns® product in their specific devices and applications, and make their own independent judgments regarding the amount of additional test margin to design into their device or application to compensate for differences between laboratory and real world conditions.

Unless Bourns has explicitly designated an individual Bourns® product as meeting the requirements of a particular industry standard (e.g., ISO/TS 16949) or a particular qualification (e.g., UL listed or recognized), Bourns is not responsible for any failure of an individual Bourns® product to meet the requirements of such industry standard or particular qualification. Users of Bourns® products are responsible for ensuring compliance with safety-related requirements and standards applicable to their devices or applications.

Bourns® products are not recommended, authorized or intended for use in nuclear, lifesaving, life-critical or life-sustaining applications, nor in any other applications where failure or malfunction may result in personal injury, death, or severe property or environmental damage. Unless expressly and specifically approved in writing by two authorized Bourns representatives on a case-by-case basis, use of any Bourns® products in such unauthorized applications might not be safe and thus is at the user’s sole risk. Life-critical applications include devices identified by the U.S. Food and Drug Administration as Class III devices and generally equivalent classifications outside of the United States.

Bourns expressly identifies those Bourns® standard products that are suitable for use in automotive applications on such products’ data sheets in the section entitled “Applications.” Unless expressly and specifically approved in writing by two authorized Bourns representatives on a case-by-case basis, use of any other Bourns® standard products in an automotive application might not be safe and thus is not recommended, authorized or intended and is at the user’s sole risk. If Bourns expressly identifies a sub-category of automotive application in the data sheet for its standard products (such as infotainment or lighting), such identification means that Bourns has reviewed its standard product and has determined that if such Bourns® standard product is considered for potential use in automotive applications, it should only be used in such sub-category of automotive applications. Any reference to Bourns® standard product in the data sheet as compliant with the AEC-Q standard or “automotive grade” does not by itself mean that Bourns has approved such product for use in an automotive application.

Bourns® standard products are not tested to comply with United States Federal Aviation Administration standards generally or any other generally equivalent governmental organization standard applicable to products designed or manufactured for use in aircraft or space applications. Bourns expressly identifies Bourns® standard products that are suitable for use in aircraft or space applications on such products’ data sheets in the section entitled “Applications.” Unless expressly and specifically approved in writing by two authorized Bourns representatives on a case-by-case basis, use of any other Bourns® standard product in an aircraft or space application might not be safe and thus is not recommended, authorized or intended and is at the user’s sole risk.

The use and level of testing applicable to Bourns® custom products shall be negotiated on a case-by-case basis by Bourns and the user for which such Bourns® custom products are specially designed. Absent a written agreement between Bourns and the user regarding the use and level of such testing, the above provisions applicable to Bourns® standard products shall also apply to such Bourns® custom products.

Users shall not sell, transfer, export or re-export any Bourns® products or technology for use in activities which involve the design, development, production, use or stockpiling of nuclear, chemical or biological weapons or missiles, nor shall they use Bourns® products or technology in any facility which engages in activities relating to such devices. The foregoing restrictions apply to all uses and applications that violate national or international prohibitions, including embargos or international regulations. Further, Bourns® products and Bourns technology and technical data may not under any circumstance be exported or re-exported to countries subject to international sanctions or embargoes. Bourns® products may not, without prior authorization from Bourns and/or the U.S. Government, be resold, transferred, or re-exported to any party not eligible to receive U.S. commodities, software, and technical data.

To the maximum extent permitted by applicable law, Bourns disclaims (i) any and all liability for special, punitive, consequential, incidental or indirect damages or lost revenues or lost profits, and (ii) any and all implied warranties, including implied warranties of fitness for particular purpose, non-infringement and merchantability.

For your convenience, copies of this Legal Disclaimer Notice with German, Spanish, Japanese, Traditional Chinese and Simplified Chinese bilingual versions are available at:

Web Page: <http://www.bourns.com/legal/disclaimers-terms-and-policies>

PDF: <http://www.bourns.com/docs/Legal/disclaimer.pdf>