

ISL8272MEVAL1Z Evaluation Board User Guide

Description

The ISL8272M is a 50A step-down DC/DC power supply module with an integrated digital PWM controller, dual-phase synchronous power switches, inductors and passives. Only input output capacitors and minimal passives are needed to finish the design. 50A of continuous output current can be delivered without a need of airflow or heatsink. The ISL8272M uses ChargeMode™ control (ASCR) architecture, which responds to a transient load within a single switching cycle.

The ISL8272MEVAL1Z evaluation board is a 4.7in x 4.8in 6-layer FR4 board with 2oz. copper in all layers. This evaluation board comes with placeholders for pin-strap resistor population to adjust output voltage, switching frequency, soft-start/stop timing and input UVLO threshold, ASCR gain and residual parameters and device PMBus™ address. More configurations, such as sequencing, Digital-DC™ (DDC) bus configuration and fault limits can be easily programmed or changed via PMBus compliant serial bus interface.

ZLUSBEVAL3Z (USB to PMBus adapter) is provided with this evaluation kit, which connects the evaluation board to a PC to activate the PMBus communication interface. The PMBus command set is accessed by using the PowerNavigator™ evaluation software from a PC running Microsoft Windows.

References

[ISL8272M](#) datasheet

Key Features

- V_{IN} range of 4.5V to 14V, V_{OUT} adjustable from 0.6V to 5V
- Programmable V_{OUT} , margining, input and output UVP/OVP, I_{OUT} limit, OTP/UTP, soft-start/stop, sequencing, and external synchronization
- Monitor: V_{IN} , V_{OUT} , I_{OUT} , temperature, duty cycle, switching frequency and faults
- ChargeMode™ control tunable with PMBus
- Mechanical switch for enable and power-good LED indicator

Specifications

This board has been configured for the following operating conditions by default:

- V_{IN} = 5V to 12V
- V_{OUT} = 1.2V
- I_{MAX} = 50A
- f_{SW} = 421kHz
- Peak efficiency: >90.5% at 70% load
- Output ripple: <10mV_{p-p}
- ASCR gain = 200, ASCR residual = 90
- On/off delay = 5ms; On/off ramp time = 5ms

Ordering Information

PART NUMBER	DESCRIPTION
ISL8272MEVAL1Z	ISL8272M Kit (Evaluation Board, ZLUSBEVAL3Z Adapter, USB Cable)

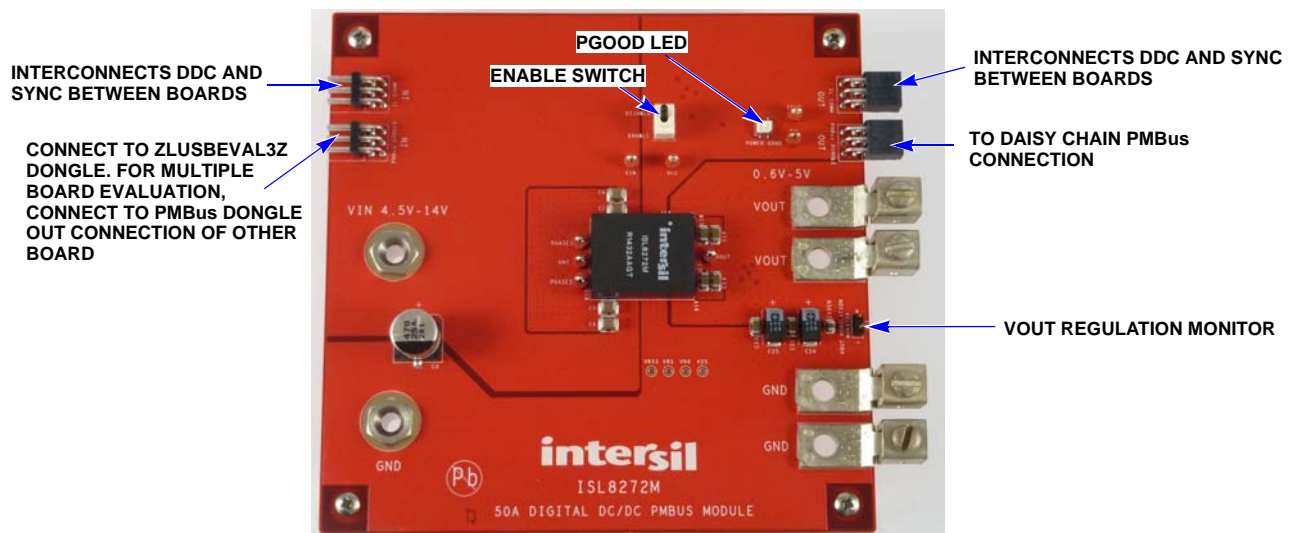

FIGURE 1. TOP SIDE

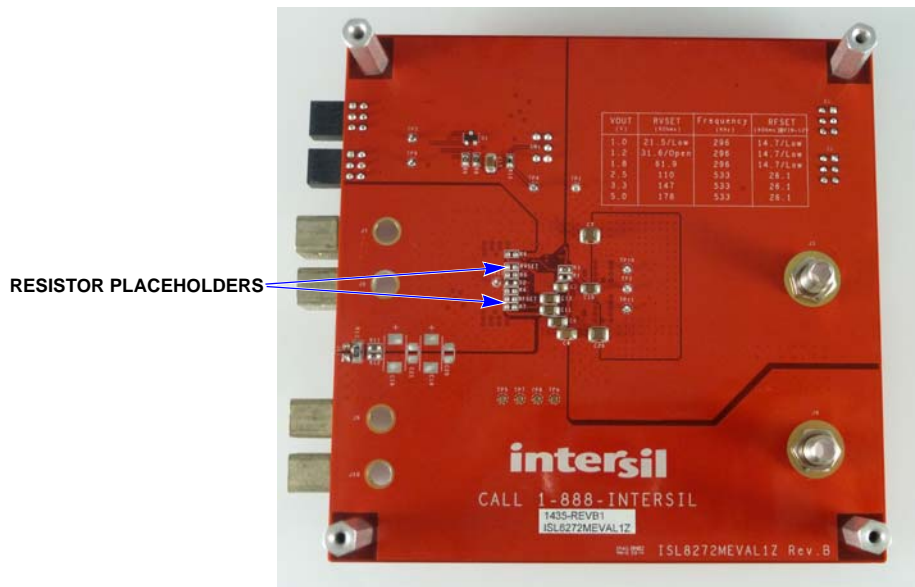

FIGURE 2. BOTTOM SIDE

Recommended Equipment

- DC power supply with minimum 15V/25A sourcing capacity
- Electronic load capable of sinking current up to 50A
- Digital multimeters (DMMs)
- Oscilloscope with higher than 100MHz bandwidth

Functional Description

The ISL8272MEVAL1Z provides all circuitry required to evaluate the features of the ISL8272M. A majority of the features of the ISL8272M, such as compensation-free ChargeMode™ control, soft-start delay and ramp times, supply sequencing, and voltage margining are available on this evaluation board. For sequencing evaluation, the board can be connected to any Intersil digital module evaluation board that supports the DDC bus.

Figures 1 and 2 show the board images of the ISL8272MEVAL1Z evaluation board.

Quick Start Guide

Pin-Strap Option

ISL8272MEVAL1Z can be configured in pin-strap mode with standard 1% 0603 resistors. PMBus interface is not required to evaluate ISL8272M in pin-strap mode. Output voltage (V_{OUT}), switching frequency (f_{SW}), soft-start/stop delay and ramp time, input undervoltage protection (UVLO) threshold, ASCR gain and residual, and device PMBus address can be changed by populating recommended resistors at placeholders provided in the evaluation board. By default, the evaluation board operates in pin-strap mode and regulates at $V_{OUT} = 1.2V$, $f_{SW} = 421kHz$, soft-start/stop delay time = 5ms, soft-start/stop ramp time = -5ms, UVLO = 4.5V, ASCR gain = 200, ASCR residual = 90 and PMBus address = 28h. Follow these steps to evaluate ISL8272M in pin-strap mode.

1. Set ENABLE switch to “DISABLE”.
2. Connect Load to VOUT lug connectors (J7-J8 and J9-J10).

3. Connect power supply to VIN connectors (J5 and J6). Make sure power supply is not enabled when making connection.
4. Turn power supply on.
5. Set ENABLE switch to “ENABLE”.
6. Measure 1.2V VOUT at probe point labeled “VOUT REGULATION MONITOR” (J11).
7. Observe switching frequency of 421kHz at probe points labeled “PHASE1” (TP10) and “PHASE2” (TP11).
8. To measure the module efficiency, connect the multimeter voltage probes at probe points labeled “VIN” (TP1), “GND” (TP2) and “VOUT” (TP12).
9. To change VOUT, disconnect board from the setup and populate a 1% standard 0603 resistor at RVSET placeholder location on bottom layer. Refer to the “Output Voltage Resistor Settings” table in the [ISL8272M](#) datasheet for recommended values. By default, VOUT_MAX is set to 110% of VOUT set by pin-strap resistor.
10. To change switching frequency, disconnect board from the setup and populate a 1% standard 0603 resistor at RFSET placeholder location on bottom layer. Refer to the “Switching Frequency Resistor Settings” table in the [ISL8272M](#) datasheet for recommended values.
11. To change soft-start/stop delay and ramp time, disconnect board from the setup and populate a 1% standard 0603 resistor at R6 placeholder location on bottom layer. Refer to the “Soft Start/Stop Resistor Settings” table in the [ISL8272M](#) datasheet for recommended values.
12. To change UVLO, disconnect board from the setup and populate a 1% standard 0603 resistor at R6 placeholder location on bottom layer. Refer to the “UVLO Resistor Settings” table in the [ISL8272M](#) datasheet for recommended values. Notice that the UVLO programming shares the same pin with soft-start/stop programming.
13. To change ASCR gain and residual, disconnect board from the setup and populate a 1% standard 0603 resistor at R7 placeholder location on bottom layer. Refer to the “ASCR

Resistor Settings” table and the design guide matrix in the [ISL8272M](#) datasheet for recommended values.

PMBus Option

ISL8272MEVAL1Z can be evaluated for all features using the provided ZLUSBEVAL3Z dongle and PowerNavigator™ evaluation software. Follow these steps to evaluate ISL8272M with PMBus option.

1. Install PowerNavigator™ software from the following Intersil website: www.intersil.com/powernavigator
2. Set ENABLE switch to “DISABLE”.
3. Connect Load to VOUT lug connectors (J7-J8 and J9-J10).
4. Connect power supply to VIN connectors (J5 and J6). Make sure power supply is not enabled when making connection.
5. Turn power supply on.
6. Connect ZLUSBEVAL3Z dongle (USB to PMBus™ adapter) to ISL8272MEVAL1Z board to the 6-pin male connector labeled as “PMBus DONGLE IN”.
7. Connect supplied USB cable from computer USB to ZLUSBEVAL3Z dongle.
8. Launch PowerNavigator™ software.
9. It is optional to load a predefined set-up from a configuration file using the PowerNavigator™ software. The ISL8272M device on the board operates in pin-strap mode from factory default, but the user may modify the operating parameters through the evaluation software or by loading a predefined set-up from a configuration file. A sample [“Configuration File” on page 6](#) is provided and can be copied to a notepad editor to make desired changes. The default pin-strap configurations will be overwritten if a user-defined configuration file is loaded.
10. Set ENABLE switch to “ENABLE”. Alternatively, the PMBus ON_OFF_CONFIG and OPERATION commands may be used from the PowerNavigator™ software to allow PMBus Enable.

11. Monitor and configure the ISL8272MEVAL1Z board using the PMBus commands in the evaluation software. To store the configuration changes, disable the module and use the command STORE_USER_ALL. To restore factory default settings, disable the module and use the command RESTORE_FACTORY and STORE_USER_ALL.
12. PowerNavigator™ tutorial videos are available at Intersil website. www.intersil.com/powernavigator
13. For sequencing via Digital-DC Bus (DDC) or to evaluate multiple Intersil digital power products using a single ZLUSBEVAL3Z dongle, ISL8272M can be daisy chained with other digital power evaluation boards. PMBus address can be changed by placing a 1% standard 0603 resistor at the R4 placeholder location on the bottom layer. Refer to the “SMBus Address Resistor Selection” table in the [ISL8272M](#) datasheet for recommended values.

Thermal Considerations and Current Derating

Board layout is very critical in order to make the module operate safely and deliver maximum allowable power. To work in the high temperature environments and carry large currents, the board layout needs to be carefully designed to maximize thermal performance. To achieve this, select enough trace width, copper weight and the proper connectors.

The ISL8272MEVAL1Z evaluation board is designed for running 50A at room temperature without additional cooling systems needed. However, if the output voltage is increased or the board is operated at elevated temperatures, then the available current is derated. Refer to the derated current curves in the [ISL8272M](#) datasheet to determine the maximum output current the evaluation board can supply. θ_{JA} is measured by inserting a thermocouple inside the module to measure peak junction temperature.

ISL8272MEVAL1Z Schematic

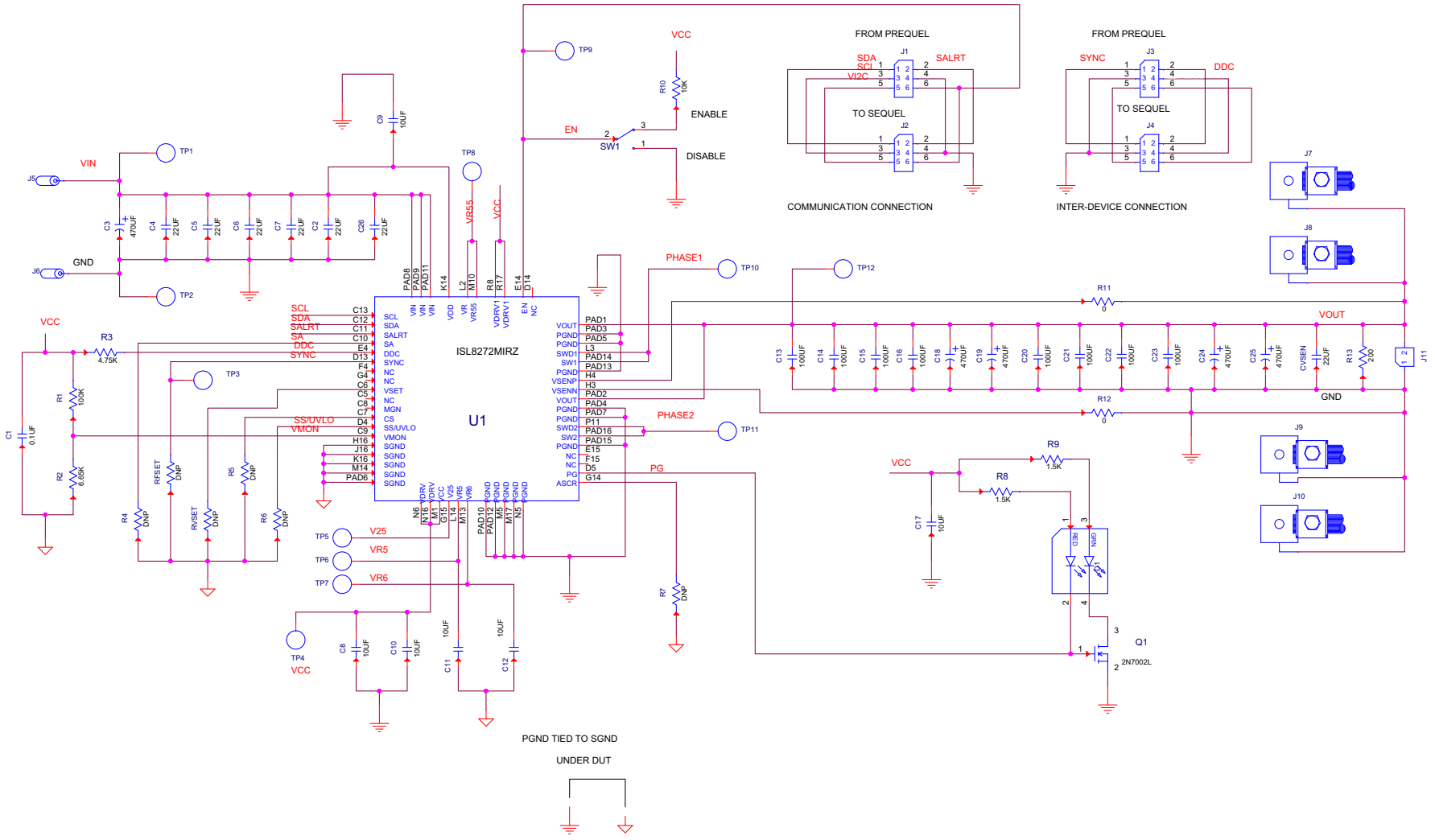

User Guide 003

Bill of Materials

REFERENCE DESIGNATORS	QTY	MANUFACTURER	MANUFACTURER PART	DESCRIPTION
C1	1	PANASONIC	ECJ-2VB1E104K	CAP, SMD, 0805, 0.1µF, 25V, 10%, X7R, ROHS
CVSEN	1	TDK	C2012X5R0J226M	CAP, SMD, 0805, 22µF, 6.3V, 20%, X5R, ROHS
C8, C10-C12, C17	5	VENKEL	C1206X7R100-106KNE	CAP, SMD, 1206, 10µF, 10V, 10%, X7R, ROHS
C9	1	VENKEL	C1206X7R250-106KNE	CAP, SMD, 1206, 10µF, 25V, 10%, X7R, ROHS
C13, C14, C15, C16, C22, C23	6	MURATA	GRM31CR60J107ME39L	CAP, SMD, 1206, 100µF, 6.3V, 20%, X5R, ROHS
C20, C21	0			CAP, SMD, 1206, DNP-PLACEHOLDER, ROHS
C2, C4, C5, C6, C7, C26	6	MURATA	GRM32ER71C226KE18L	CAP, SMD, 1210, 22µF, 16V, 10%, X7R, ROHS
C24, C25	2	SANYO	6TPE470MI	CAP-POSCAP, LOW ESR, SMD, D4, 470µF, 6.3V, 20%, 18mΩ, ROHS
C3	1	PANASONIC	EEE-1EA471P	CAP, SMD, 10mm, 470µF, 25V, 20%, ALUM.ELEC., 380mA, ROHS
J5, J6	2	JOHNSON COMPONENTS	108-0740-001	CONN-JACK, BANANA-SS-SDRLESS, VERTICAL, ROHS
TP1-TP4, TP9-TP12	8	KEYSTONE	5005	CONN-COMPACT TEST PT, VERTICAL, RED, ROHS
J11	1	BERG/FCI	69190-202HLF	CONN-HEADER, 1X2, RETENTIVE, 2.54mm, 0.230 x 0.120, ROHS
J2, J4	2	SAMTEC	SSQ-103-02-T-D-RA	CONN-SOCKET STRIP, TH, 2x3, 2.54mm, TIN, R/A, ROHS
J1, J3	2	SAMTEC	TSW-103-08-T-D-RA	CONN-HEADER, 2x3, BRKAWY, 2.54mm, TIN, R/A, ROHS
D1	1	LUMEX	SSL-LXA3025IGC-TR	LED, SMD, 3x2.5mm, 4P, RED/GREEN, 12/20MCD, 2V
U1	1	INTERSIL	ISL8272MAIRZ	IC-50A DIGITAL DC/DC MODULE, 42P, HDA, ROHS
Q1	1	ON SEMICONDUCTOR	2N7002LT1G	TRANSISTOR-MOS, N-CHANNEL, SMD, SOT23, 60V, 115mA, ROHS
R4, R5, R6, R7, RFSET, RVSET	0			RESISTOR, SMD, 0603, 0.1%, MF, DNP-PLACEHOLDER
R11, R12	2	VENKEL	CR0603-10W-000T	RES, SMD, 0603, 0Ω, 1/10W, TF, ROHS
R10	1	KOA	RK73H1JT1002F	RES, SMD, 0603, 10k, 1/10W, 1%, TF, ROHS
R1	1	VENKEL	CR0603-10W-1003FT	RES, SMD, 0603, 100k, 1/10W, 1%, TF, ROHS
R8, R9	2	VENKEL	CR0603-10W-1501FT	RES, SMD, 0603, 1.5k, 1/10W, 1%, TF, ROHS
R3	1	VENKEL	CR0603-10W-4751FT	RES, SMD, 0603, 4.75k, 1/10W, 1%, TF, ROHS
R2	1	YAGEO	RC0603FR-076K65L	RES, SMD, 0603, 6.65k, 1/10W, 1%, TF, ROHS
R13	1	PANASONIC	ERJ-8ENF2000V	RES, SMD, 1206, 200Ω, 1/4W, 1%, TF, ROHS
SW1	1	C&K COMPONENTS	GT13MCBE	SWITCH-TOGGLE, THRU-HOLE, 5PIN, SPDT, 3POS, ON-OFF-ON, ROHS
J7, J8, J9, J10	4	BERG/FCI	KPA8CTP	HDWARE, MTG, CABLE TERMINAL, 6-14AWG, LUG&SCREW, ROHS
C18, C19	0			DO NOT POPULATE
TP5, TP6, TP7, TP8	0			DO NOT POPULATE

Configuration File

Sample Configuration File for ISL8272M Module. Copy and paste (from RESTORE_FACTORY TO ### End User Store) to a notepad and save it as Confile_file_name.txt. The # symbol is used for a comment line. Following settings are already loaded to ISL8272M module as factory defaults.

```

RESTORE_FACTORY                # reset device to the factory setting
STORE_USER_ALL                 # Clears user memory space
# VOUT Related
VOUT_COMMAND                   0x2666                # 1.2 V
VOUT_MAX                       0x2a3c                # 1.32 V
VOUT_MARGIN_HIGH               0x2851                # 1.26 V
VOUT_MARGIN_LOW                0x247a                # 1.14 V
VOUT_OV_FAULT_LIMIT            0x2c28                # 1.38 V
VOUT_OV_FAULT_RESPONSE         0x80                 # Disable and no retry
VOUT_OV_WARN_LIMIT             0x2a3c                # 1.32 V
VOUT_UV_WARN_LIMIT             0x228f                # 1.08 V
VOUT_UV_FAULT_LIMIT            0x20a3                # 1.02 V
VOUT_UV_FAULT_RESPONSE         0x80                 # Disable and no retry
POWER_GOOD_ON                  0x228f                # 1.08 V
VOUT_TRANSITION_RATE           0xba00                # 1 mV/us
VOUT_DROOP                     0x0000                # 0 mV/A
VOUT_CAL_OFFSET                0x0000                # 0 mV/A
# IOUT Related
IOUT_CAL_GAIN                   0xb370                # 0.86 mV/A
IOUT_CAL_OFFSET                0x0000                # 0 A
IOUT_OC_FAULT_LIMIT            0xe3c0                # 60 A
IOUT_UC_FAULT_LIMIT            0xe440                # -60A
MFR_IOUT_OC_FAULT_RESPONSE     0x80                 # Disable and no retry
MFR_IOUT_UC_FAULT_RESPONSE     0x80                 # Disable and no retry
ISENSE_CONFIG                   0x05                 # 256ns Blanking time, Mid-Range
# Other Faults
OT_FAULT_LIMIT                 0xebe8                # 125 °C
OT_FAULT_RESPONSE              0x80                 # Disable and no retry
OT_WARN_LIMIT                  0xeb70                # 110 °C
UT_WARN_LIMIT                  0xdc40                # -30 °C
UT_FAULT_LIMIT                 0xe530                # -45 °C
UT_FAULT_RESPONSE              0x80                 # Disable and no retry
VIN_OV_FAULT_LIMIT             0xd380                # 14 V
VIN_OV_FAULT_RESPONSE          0x80                 # Disable and no retry
VIN_OV_WARN_LIMIT              0xd353                # 13.3 V
VIN_UV_WARN_LIMIT              0xca5d                # 4.73 V
VIN_UV_FAULT_LIMIT             0xca40                # 4.5 V
VIN_UV_FAULT_RESPONSE          0x80                 # Disable and no retry
#Enable, Timing and Sequence Related
ON_OFF_CONFIG                  0x16                 # Pin Enable, Soft Off
TON_DELAY                      0xca80                # 5 ms
TON_RISE                       0xca80                # 5 ms
TOFF_DELAY                     0xca80                # 5 ms
TOFF_FALL                      0xca80                # 5 ms
POWER_GOOD_DELAY               0xca00                # 4 ms
FREQUENCY_SWITCH               0x0215                # 533 kHz
SYNC_CONFIG                    0x00                 # Use Pin-strap for FSW setting
SEQUENCE                       0x0000                # Sequence Disabled
# Manufacturer Related
MFR_ID                         Intersil Corp         # Example Only
MFR_MODEL                      ISL8272MEVAL1Z       # Example Only
MFR_REVISION                   Rev-1                 # Example Only
MFR_LOCATION                   Milpitas, CA          # Example Only
MFR_DATE                       09/05/2014           # Example Only
MFR_SERIAL                     1234                 # Example Only
USER_DATA_00                   Module                # Example Only
# Advance Settings
USER_CONFIG                     0x80                 # ASCR on for Start, Open Drain PG
DDC_CONFIG                     0x0a01               # DDC rail ID = 10, 2-phase
DDC_GROUP                      0x00000000          # All Broadcast disabled
# Loop Compensation
ASCR_CONFIG                     0x15a0100           # ASCR gain = 256, Residual = 90
STORE_USER_ALL                 # Store all above settings to NVRAM
### End User Store

```

Layout

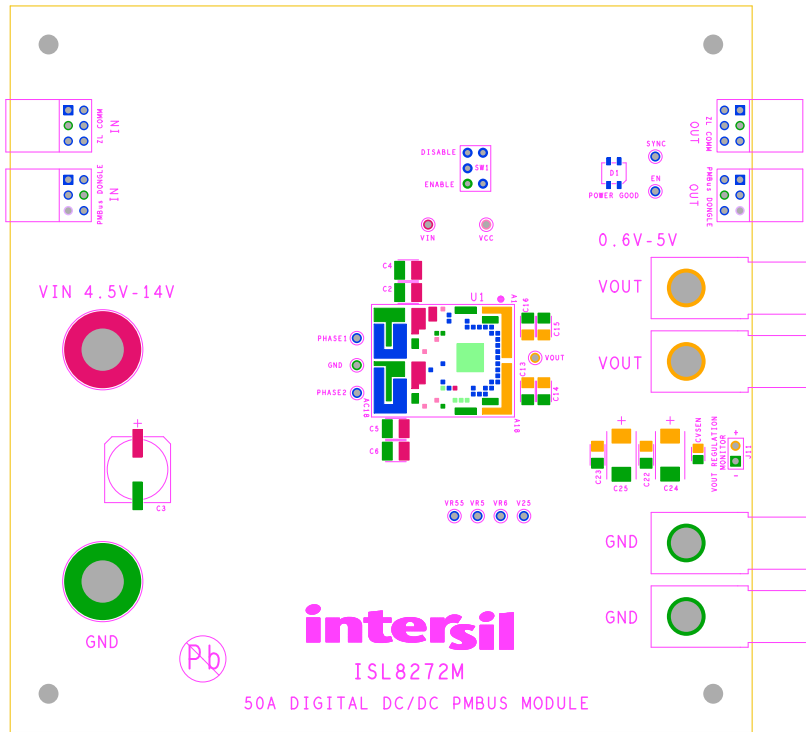

FIGURE 3. SILKSCREEN TOP

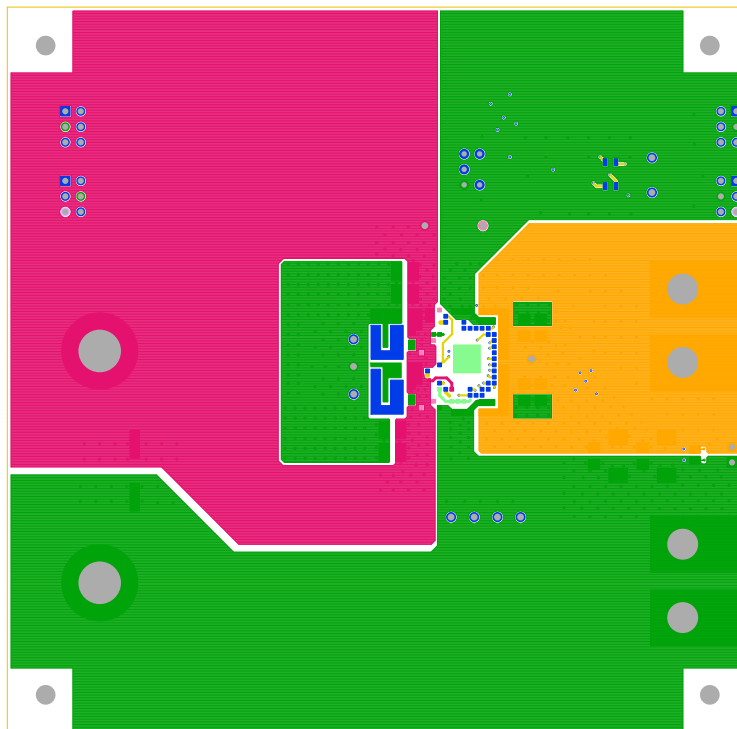

FIGURE 4. TOP LAYER COMPONENT SIDE

Layout (Continued)

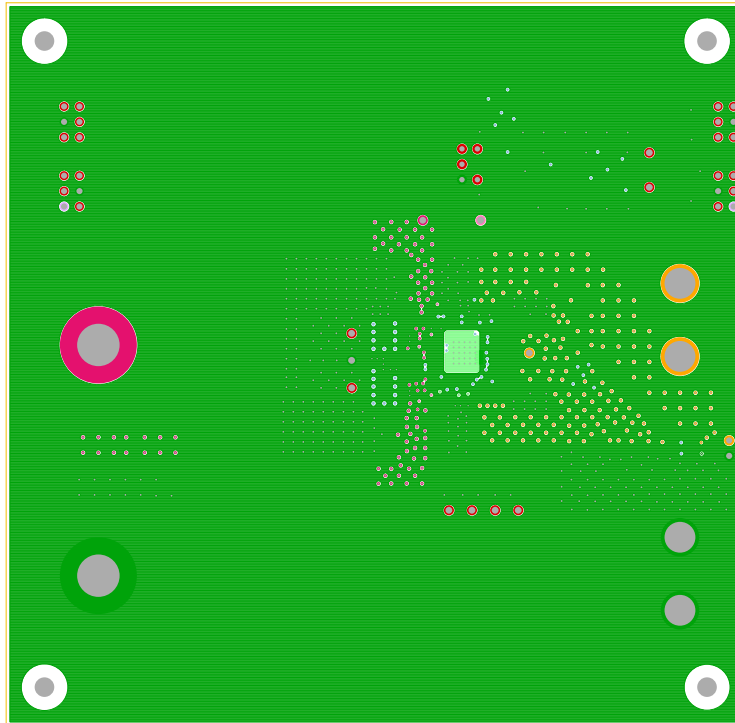

FIGURE 5. LAYER 2

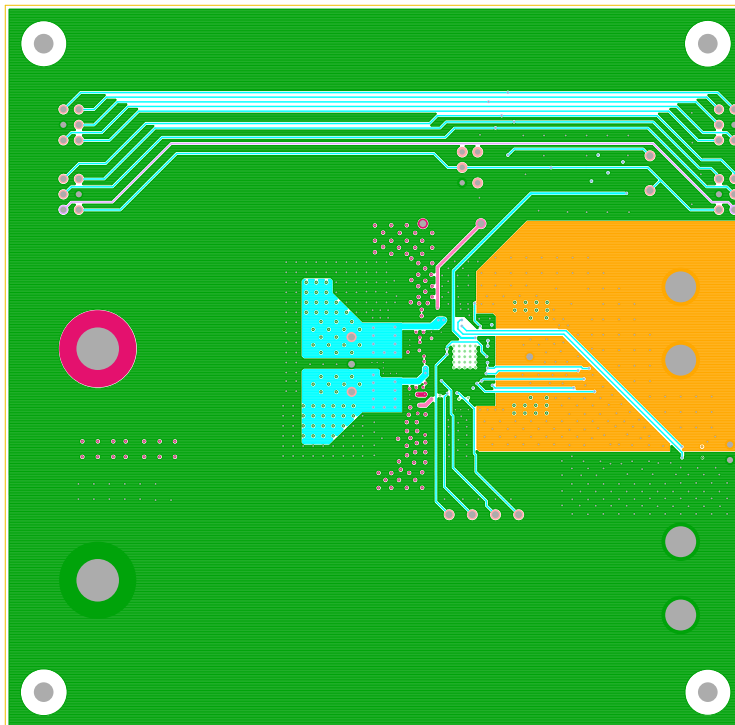

FIGURE 6. LAYER 3

Layout (Continued)

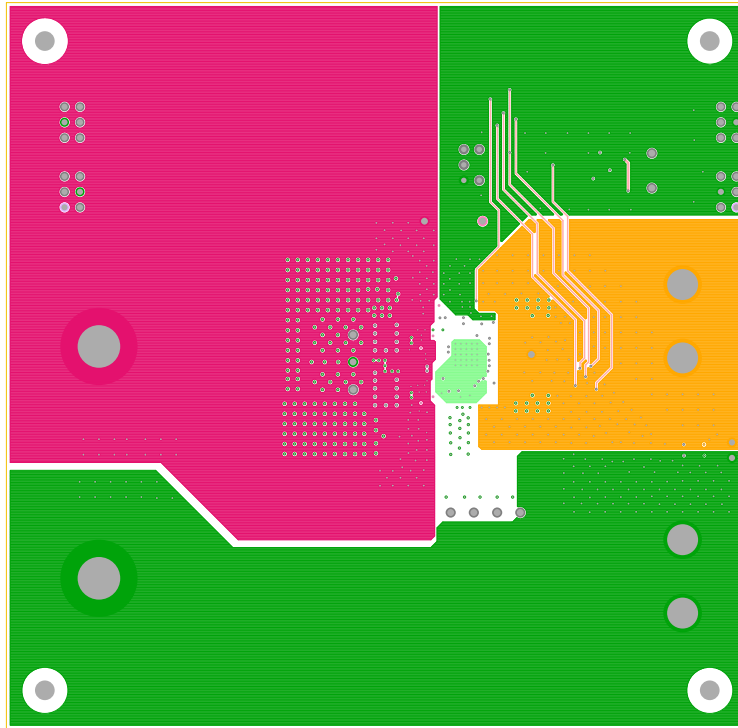

FIGURE 7. LAYER 4

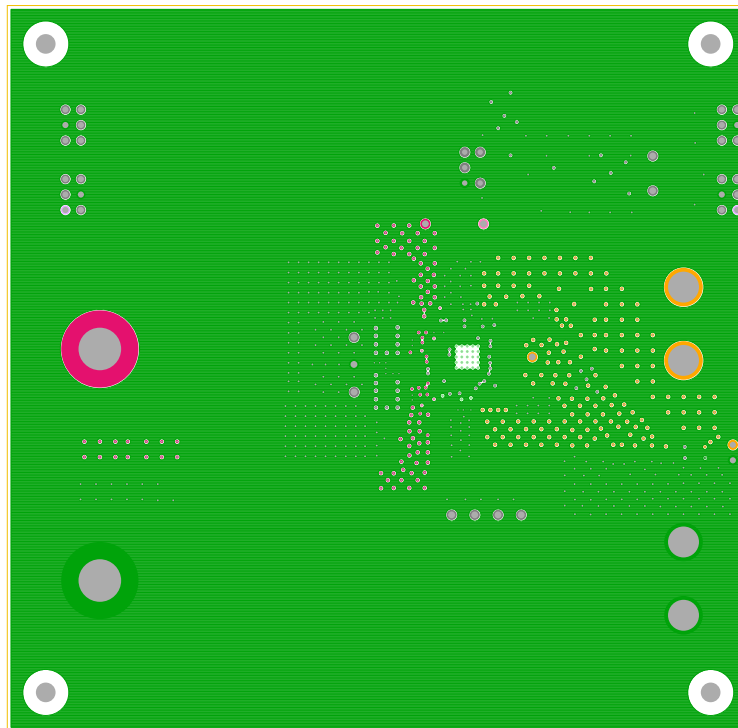

FIGURE 8. LAYER 5

Layout (Continued)

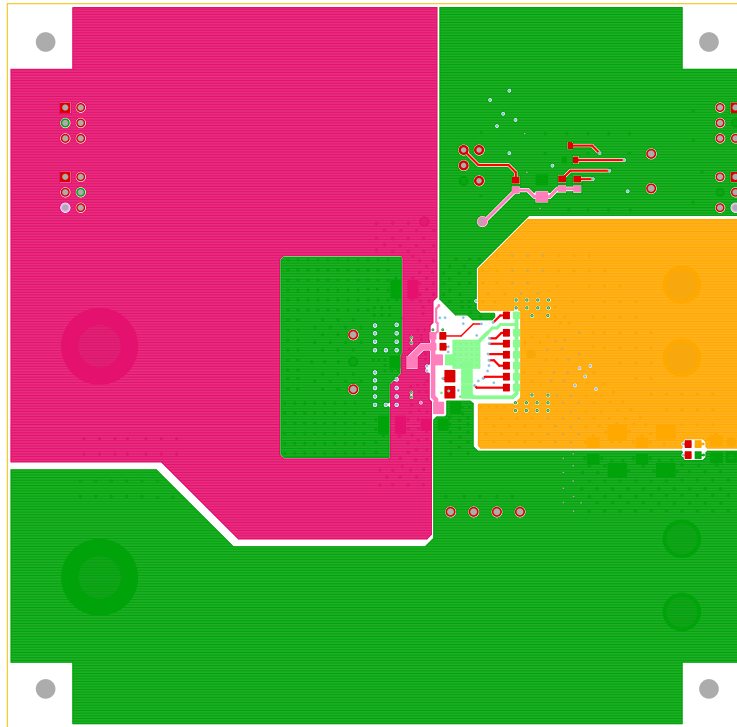

FIGURE 9. BOTTOM LAYER SOLDER SIDE

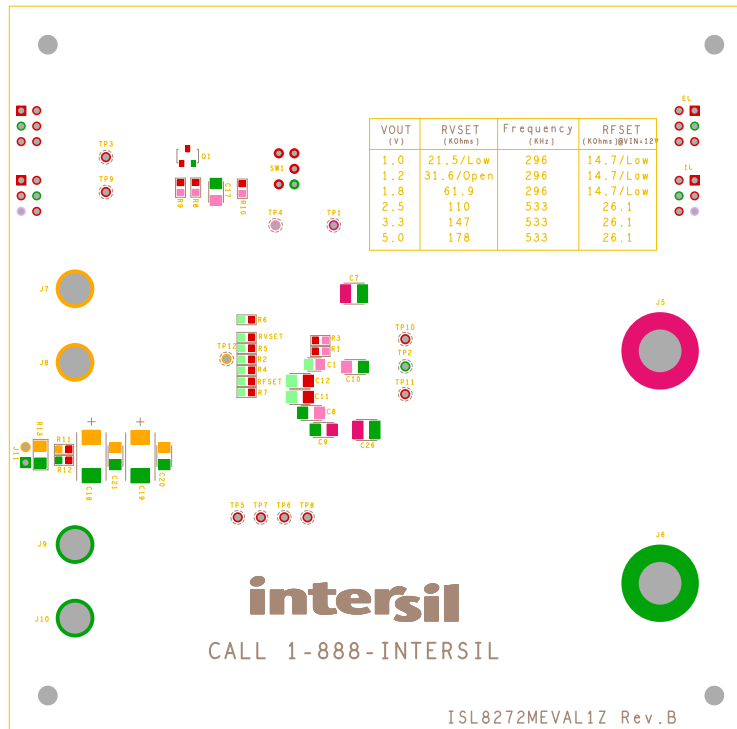

FIGURE 10. SILKSCREEN BOTTOM

Typical Performance Data The following data was acquired using a ISL8272MEVAL1Z evaluation board.

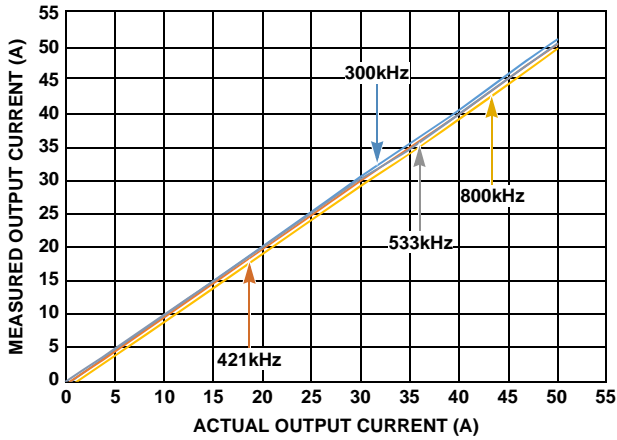

FIGURE 11. OUTPUT CURRENT MEASUREMENT ACCURACY AT $V_{IN} = 12V$, $V_{OUT} = 1V$, $T_A = +25^\circ C$ FOR VARIOUS SWITCHING FREQUENCIES

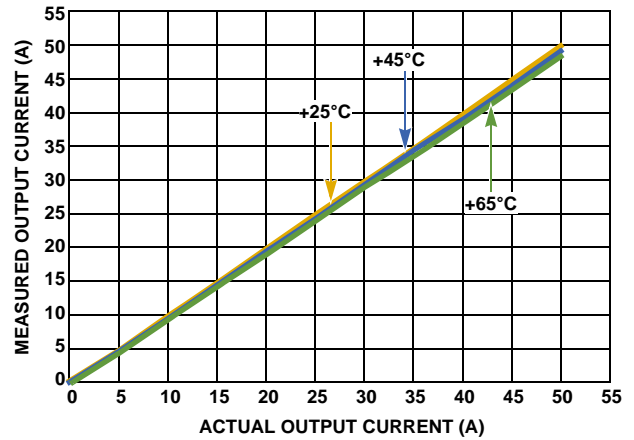

FIGURE 12. OUTPUT CURRENT MEASUREMENT ACCURACY AT $V_{IN} = 12V$, $V_{OUT} = 1V$, $f_{SW} = 533kHz$ FOR VARIOUS AMBIENT TEMPERATURES

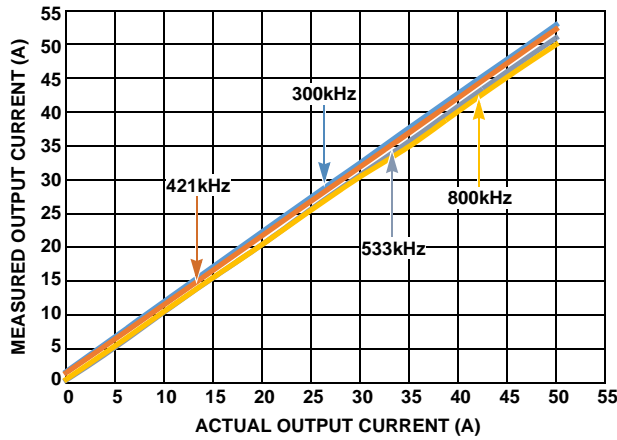

FIGURE 13. OUTPUT CURRENT MEASUREMENT ACCURACY AT $V_{IN} = 12V$, $V_{OUT} = 3.3V$, $T_A = +25^\circ C$ FOR VARIOUS SWITCHING FREQUENCIES

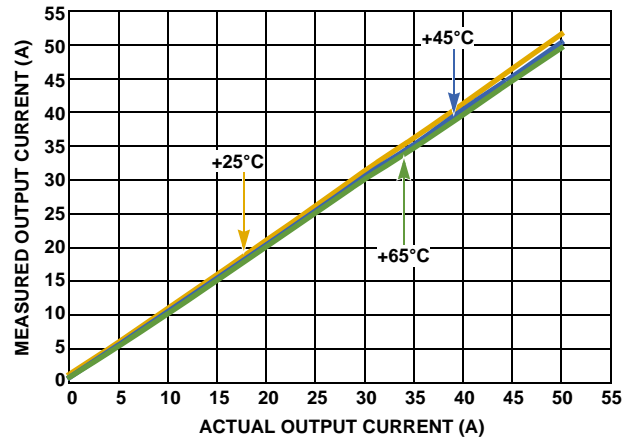

FIGURE 14. OUTPUT CURRENT MEASUREMENT ACCURACY AT $V_{IN} = 12V$, $V_{OUT} = 3.3V$, $f_{SW} = 533kHz$ FOR VARIOUS AMBIENT TEMPERATURES

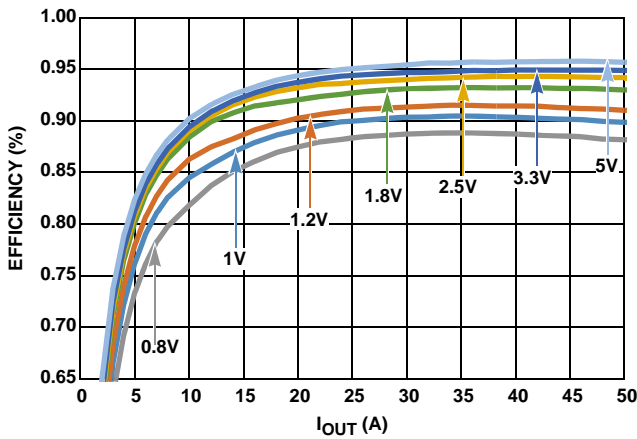

FIGURE 15. EFFICIENCY vs OUTPUT CURRENT AT $V_{IN} = 12V$, $f_{SW} = 300kHz$ FOR VARIOUS OUTPUT VOLTAGES

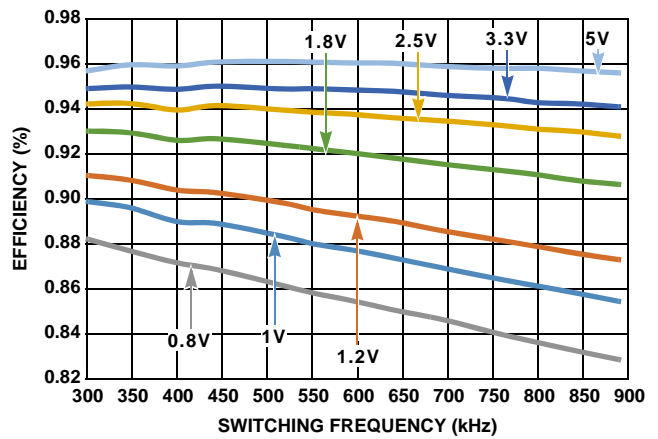

FIGURE 16. EFFICIENCY vs SWITCHING FREQUENCY AT $V_{IN} = 12V$, $I_{OUT} = 50A$ FOR VARIOUS OUTPUT VOLTAGES

Typical Performance Data The following data was acquired using a ISL8272MEVAL1Z evaluation board. (Continued)

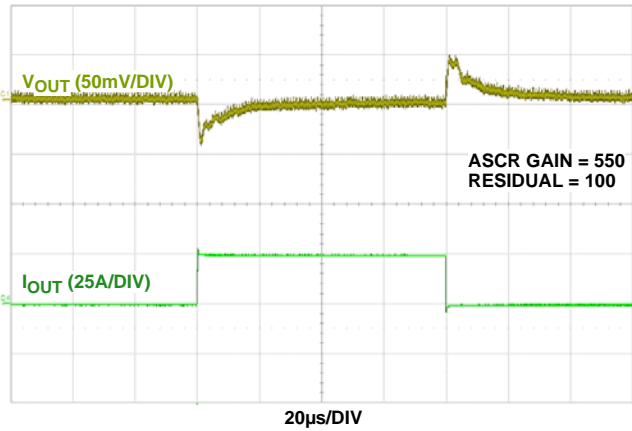

FIGURE 17. LOAD TRANSIENT RESPONSE AT $V_{IN} = 12V$, $V_{OUT} = 1V$, $I_{OUT} = 0A$ TO $25A$ ($>100A/\mu s$), $f_{SW} = 533kHz$. $C_{OUT} = 8 \times 100\mu F$ CERAMIC + $4 \times 470\mu F$ POSCAP

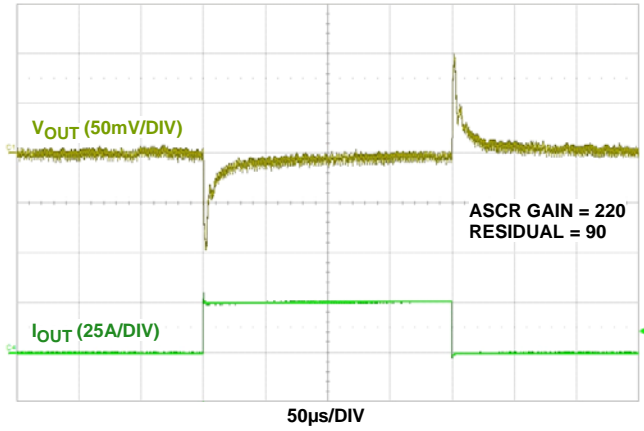

FIGURE 18. LOAD TRANSIENT RESPONSE AT $V_{IN} = 12V$, $V_{OUT} = 3.3V$, $I_{OUT} = 0A$ TO $25A$ ($>100A/\mu s$), $f_{SW} = 533kHz$. $C_{OUT} = 4 \times 100\mu F$ CERAMIC + $2 \times 470\mu F$ POSCAP

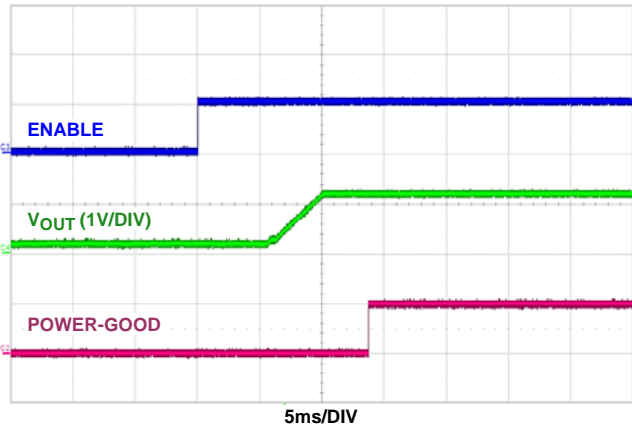

FIGURE 19. SOFT-START AT $V_{IN} = 12V$, $V_{OUT} = 1.2V$, $TON_DELAY = 5ms$, $TON_RISE = 5ms$, $POWER_GOOD_DELAY = 4ms$

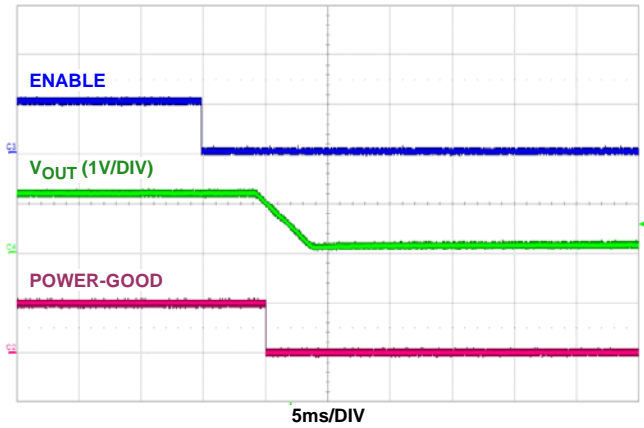

FIGURE 20. SOFT-STOP AT $V_{IN} = 12V$, $V_{OUT} = 1.2V$, $TOFF_DELAY = 5ms$, $TOFF_FALL = 5ms$

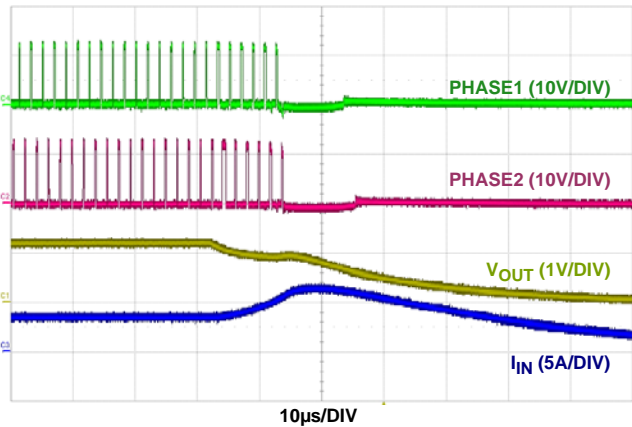

FIGURE 21. OUTPUT SHORT CIRCUIT PROTECTION AT $V_{IN} = 12V$, $V_{OUT} = 1.2V$, $f_{SW} = 533kHz$

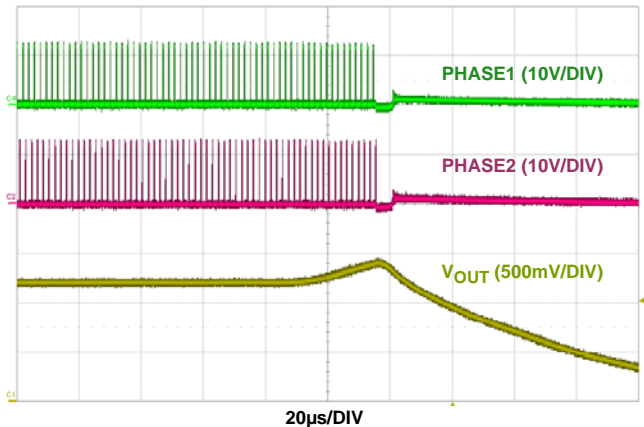

FIGURE 22. OUTPUT OVERVOLTAGE PROTECTION AT $V_{IN} = 12V$, $V_{OUT} = 1.2V$, $f_{SW} = 533kHz$, $V_{OUT_OV_FAULT_LIMIT} = 1.38V$

Typical Performance Data The following data was acquired using a ISL8272MEVAL1Z evaluation board. (Continued)

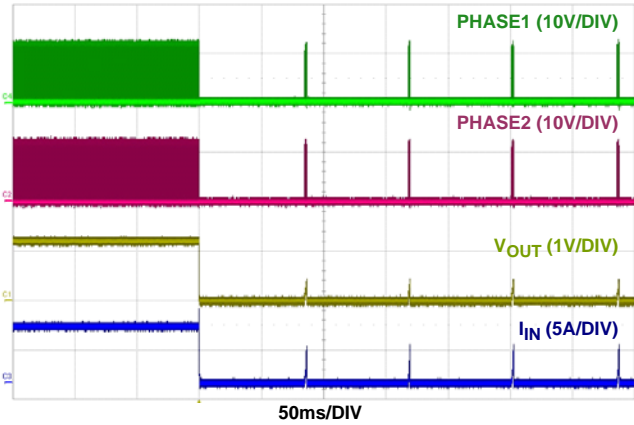

FIGURE 23. OUTPUT SHORT CIRCUIT PROTECTION WITH CONTINUOUS RETRY ENABLED (HICCUP MODE), $V_{IN} = 12V$, $V_{OUT} = 1.2V$

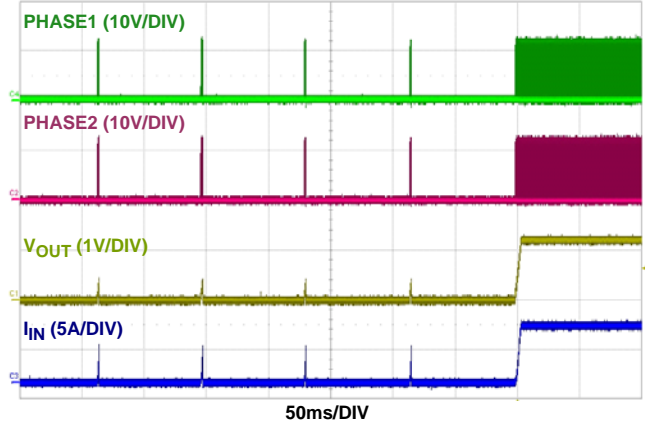

FIGURE 24. OUTPUT SHORT CIRCUIT RECOVERY FROM CONTINUOUS RETRY (HICCUP MODE). $V_{IN} = 12V$, $V_{OUT} = 1.2V$

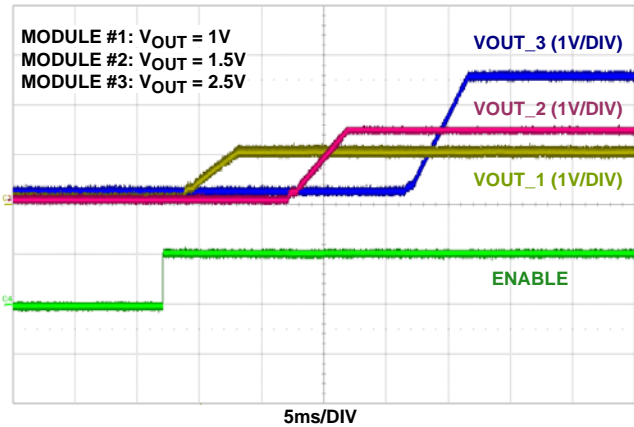

FIGURE 25. SOFT-START WITH OUTPUT SEQUENCING AT $V_{IN} = 12V$, THREE ISL8272MEVAL1Z BOARDS ARE CONNECTED IN DAISY CHAIN

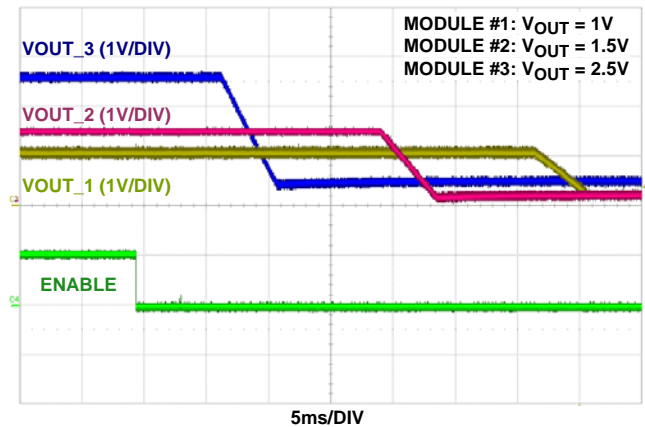

FIGURE 26. SOFT-STOP WITH OUTPUT SEQUENCING AT $V_{IN} = 12V$, THREE ISL8272MEVAL1Z BOARDS ARE CONNECTED IN DAISY CHAIN

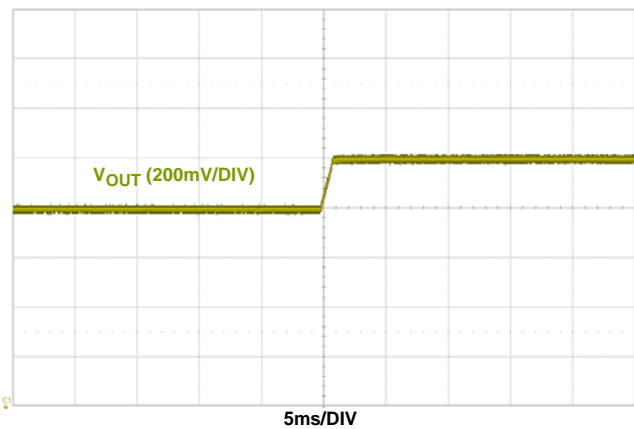

FIGURE 27. DYNAMIC VOLTAGE SCALING WITH V_{OUT} CHANGE FROM 1.1V TO 1.3V, $V_{IN} = 12V$, $V_{OUT_TRANSITION_RATE} = 1mV/\mu s$

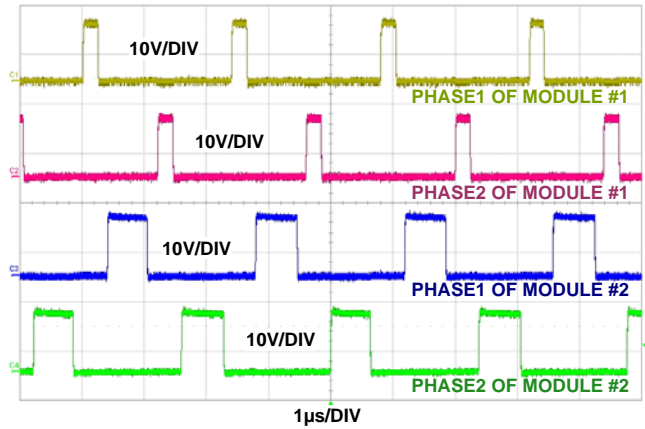

FIGURE 28. PHASE SPREADING/INTERLEAVING, TWO ISL8272MEVAL1Z BOARDS ARE CONNECTED IN DAISY CHAIN, MODULE #1 RAIL POSITION: 0; MODULE #2 RAIL POSITION:4. $V_{IN} = 12V$, $V_{OUT_1} = 1.2V$, $V_{OUT_2} = 3.3V$, $f_{SW} = 421kHz$

Typical Performance Data

The following data was acquired using a ISL8272MEVAL1Z evaluation board. (Continued)

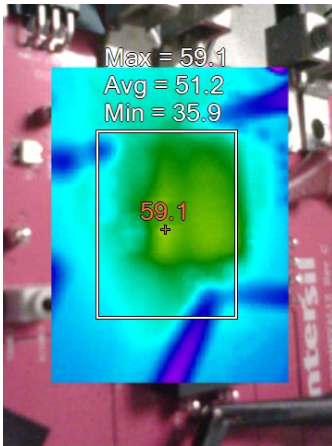

FIGURE 29. THERMAL IMAGE AT $V_{IN} = 12V$, $V_{OUT} = 1V$, $I_{OUT} = 50A$, $f_{SW} = 300kHz$, $T_A = +25^\circ C$, NO AIRFLOW

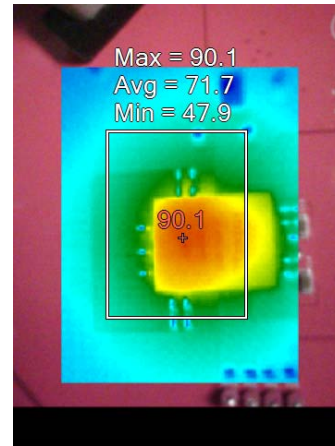

FIGURE 30. THERMAL IMAGE AT $V_{IN} = 14V$, $V_{OUT} = 5V$, $I_{OUT} = 50A$, $f_{SW} = 533kHz$, $T_A = +25^\circ C$, NO AIRFLOW

Intersil Corporation reserves the right to make changes in circuit design, software and/or specifications at any time without notice. Accordingly, the reader is cautioned to verify that the Application Note or Technical Brief is current before proceeding.

For information regarding Intersil Corporation and its products, see www.intersil.com