

Data sheet | Item number: 832-1103/343-000

1-conductor female connector; lever; Push-in CAGE CLAMP®; 16 mm²; Pin spacing 10.16 mm; 3-pole; 100% protected against mismatching; Centered locking levers; Strain relief plate; Silver-plated contacts; 16,00 mm²; light gray

www.wago.com/832-1103/343-000

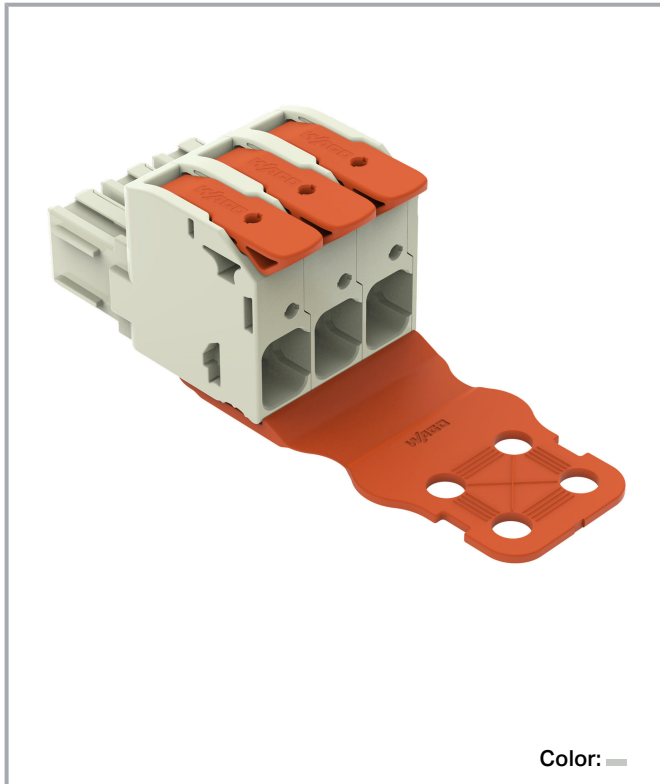

Subject to changes. Please also observe the further product documentation!

WAGO GmbH & Co. KG
Hansastr. 27
32423 Minden
Phone: +49571 887-0 | Fax: +49571 887-169
Email: info.de@wago.com | Web: www.wago.com

Do you have any questions about our products?
We are always happy to take your call at +49 (571) 887-44222.

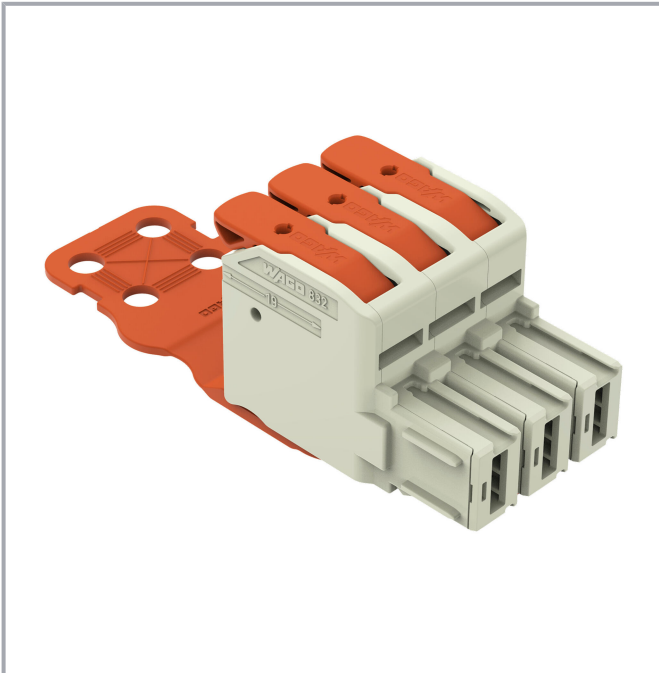

Derating Curve

1-conductor female connector (832-1102) with
THT male header (832-3622)

Pin spacing: 10.16 mm / Conductor cross-section: 25 mm² "f-st"
Based on: EN 60512-5-2 / Reduction factor: 0.8

Current in A

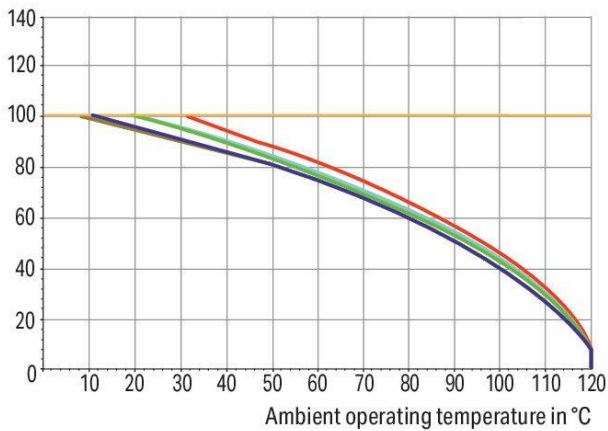

2-, 3-, 4-, 5-, 6- pole ——— Conductor rated current

Derating Curve

1-conductor female connector (832-1102) with
THT male header (832-3622)

Pin spacing: 10.16 mm / Conductor cross-section: 16 mm² "f-st"
Based on: EN 60512-5-2 / Reduction factor: 0.8

Current in A

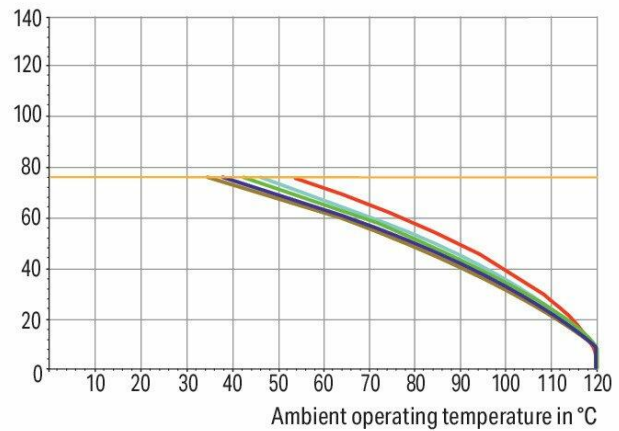

2-, 3-, 4-, 5-, 6- pole ——— Conductor rated current

Subject to changes. Please also observe the further product documentation!

WAGO GmbH & Co. KG

Hansastr. 27

32423 Minden

Phone: +49571 887-0 | Fax: +49571 887-169

Email: info.de@wago.com | Web: www.wago.com

Do you have any questions about our products?

We are always happy to take your call at +49 (571) 887-44222.

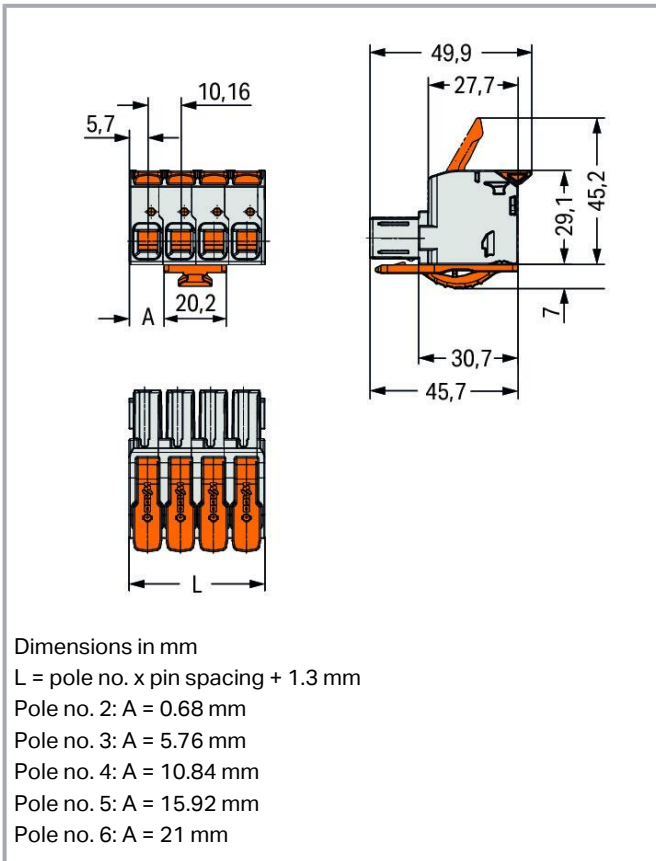

Item description

- Intuitive and tool-free lever actuation
- Universal connection for all conductor types
- Push-in termination of solid or ferruled conductors
- Test slot 0° and 90° to conductor entry
- 100% protected against mismatching
- Coding option available

Data

Notes

Safety information

The *MCS – MULTI CONNECTION SYSTEM* includes connectors without breaking capacity in accordance with DIN EN 61984. When used as intended, these connectors must not be connected /disconnected when live or under load. When used as intended, these connectors must not be connected/disconnected when live

Subject to changes. Please also observe the further product documentation!



or under load. The circuit design should ensure header pins, which can be touched, are not live when unmated.

Variants:

Other pole numbers

Other versions (or variants) can be requested from WAGO Sales or configured at <https://configurator.wago.com/>.

Electrical data

Ratings per IEC/EN

Ratings per	IEC/EN 60664-1
Nominal voltage (III/3)	1000 V
Rated impulse voltage (III/3)	8 kV
Rated voltage (III/2)	1000 V
Rated impulse voltage (III/2)	8 kV
Nominal voltage (II/2)	1000 V
Rated surge voltage (II/2)	8 kV
Rated current	76 A
Legend (ratings)	(III / 2) $\hat{=}$ Overvoltage category III / Pollution degree 2

Ratings per UL 1059

Approvals per	UL 1059
Rated voltage UL (Use Group B)	600 V
Rated current UL (Use Group B)	66 A
Rated voltage UL (Use Group C)	600 V
Rated current UL (Use Group C)	66 A

Ratings per UL 1977

Rated voltage (UL 1977)	600 V
Rated current UL 1977	85 A

Ratings per CSA

Approvals per	CSA
Rated voltage CSA (Use Group B)	600 V
Rated current CSA (Use Group B)	66 A
Rated voltage CSA (Use Group C)	600 V
Rated current CSA (Use Group C)	66 A

Subject to changes. Please also observe the further product documentation!



Connection data

Total number of potentials	3
Number of connection types	1
Number of levels	1

Connection 1

Connection technology	Push-in CAGE CLAMP®
Actuation type	Lever
Solid conductor	0.75 ... 16 mm ² / 18 ... 4 AWG
Fine-stranded conductor	0.75 ... 25 mm ² / 18 ... 4 AWG
Fine-stranded conductor; with insulated ferrule	0.75 ... 16 mm ²
Fine-stranded conductor; with uninsulated ferrule	0.75 ... 16 mm ²
Strip length	18 ... 20 mm / 0.71 ... 0.79 inches
Pole number	3
Conductor entry direction to mating direction	0°

Physical data

Pin spacing	10.16 mm / 0.4 inches
Width	31.78 mm / 1.251 inches
Height	36.1 mm
Depth	94.8 mm / 3.732 inches

Mechanical Data

Variable coding	Yes
Anti-rotation protection	Yes

Plug-in connection

Contact type (pluggable connector)	Female connector/socket
Connector (connection type)	for conductor
Mismating protection	Yes
Plugging without loss of pin spacing	No
Strain relief	Strain relief plate

Material Data

Note (material data)

[Information on material specifications can be found here](#)

Subject to changes. Please also observe the further product documentation!



Color	light gray
Material group	I
Insulation material	Polybutylene terephthalate (PBT)
Flammability class per UL94	V0
Clamping spring material	Chrome-nickel spring steel (CrNi)
Material of the additional spring for socket contact	Chrome-nickel spring steel (CrNi)
Contact material	Electrolytic copper (E _{Cu})
Contact plating	Silver
Fire load	0.847 MJ
Actuator color	orange
Weight of insulation material	16.34 g
Weight	45.2 g

Environmental requirements

Limit temperature range	-60 ... +120 °C
Processing temperature	-35 ... +60 °C

Commercial data

ETIM 8.0	EC001284
ETIM 7.0	EC001284
PU (SPU)	15 pcs
Packaging type	box
Country of origin	DE
GTIN	4055143961752
Customs tariff number	85366990990

Environmental Product Compliance

RoHS Compliance Status	Compliant, No Exemption
------------------------	-------------------------

Approvals / Certificates

General approvals

Logo	Approval	Additional Approval Text	Certificate name
	UL Underwriters Laboratories Inc.	C22.2 No. 158	E45172

Subject to changes. Please also observe the further product documentation!



Counterpart



Item no. 832-1203

1-conductor male connector; lever; Push-in CAGE CLAMP®; 16 mm²; Pin spacing 10.16 mm; 3-pole; 100% protected against mismatching; Silver-plated contacts; 16,00 mm²; light gray

www.wago.com/832-1203



Item no. 832-3603

THT male header; 1.2 x 1.2 mm solder pin; straight; 100% protected against mismatching; Silver-plated contacts; Pin spacing 10.16 mm; 3-pole; light gray

www.wago.com/832-3603



Item no. 832-3623

THT male header; 1.2 x 1.2 mm solder pin; angled; 100% protected against mismatching; Silver-plated contacts; Pin spacing 10.16 mm; 3-pole; light gray

www.wago.com/832-3623



Item no. 832-3643

THT male header; 1.2 x 1.2 mm solder pin; angled; 100% protected against mismatching; Silver-plated contacts; Pin spacing 10.16 mm; 3-pole; light gray

www.wago.com/832-3643



Item no. 832-1203/333-000

1-conductor male connector; lever; Push-in CAGE CLAMP®; 16 mm²; Pin spacing 10.16 mm; 3-pole; 100% protected against mismatching; Strain relief plate; Silver-plated contacts; 16,00 mm²; light gray

www.wago.com/832-1203/333-000

Optional accessories

Coding

Coding



Item no.: 832-500

Coding key carrier; orange

www.wago.com/832-500

Ferrule

Ferrule



Item no.: 216-210

Ferrule; Sleeve for 16 mm² / AWG 6; insulated; electro-tin plated; electrolytic copper; gastight crimped; acc. to DIN 46228, Part 4/09.90; blue

www.wago.com/216-210



Item no.: 216-284

Ferrule; Sleeve for 1.5 mm² / AWG 16; insulated; electro-tin plated; electrolytic copper; gastight crimped; acc. to DIN 46228, Part 4/09.90; black

www.wago.com/216-284

Subject to changes. Please also observe the further product documentation!

WAGO GmbH & Co. KG

Hansastr. 27

32423 Minden

Phone: +49571 887-0 | Fax: +49571 887-169

Email: info.de@wago.com | Web: www.wago.com

Do you have any questions about our products?

We are always happy to take your call at +49 (571) 887-44222.



Item no.: 216-286

Ferrule; Sleeve for 2.5 mm² / AWG 14; insulated; electro-tin plated; electrolytic copper; gastight crimped; acc. to DIN 46228, Part 4/09.90; blue

www.wago.com/216-286



Item no.: 216-287

Ferrule; Sleeve for 4 mm² / AWG 12; insulated; electro-tin plated; electrolytic copper; gastight crimped; acc. to DIN 46228, Part 4/09.90; gray

www.wago.com/216-287



Item no.: 216-288

Ferrule; Sleeve for 6 mm² / AWG 10; insulated; electro-tin plated; electrolytic copper; gastight crimped; acc. to DIN 46228, Part 4/09.90; yellow

www.wago.com/216-288



Item no.: 216-289

Ferrule; Sleeve for 10 mm² / AWG 8; insulated; electro-tin plated; electrolytic copper; gastight crimped; acc. to DIN 46228, Part 4/09.90; red

www.wago.com/216-289

Downloads

Documentation

Additional Information

Technical Section	2019 Apr 3	pdf	Download
Technical explanations		2.0 MB	

Environmental Product Compliance

Compliance Search

Environmental Product Compliance 832-1103/343-000	URL	Download
1-conductor female connector; lever; Push-in CAGE CLAMP®; 16 mm ² ; Pin spacing 10.16 mm; 3-pole; 100% protected against mismatching; Centered locking levers; Strain relief plate; Silver-plated contacts; 16,00 mm ² ; light gray		

Installation Notes

Conductor termination

Subject to changes. Please also observe the further product documentation!

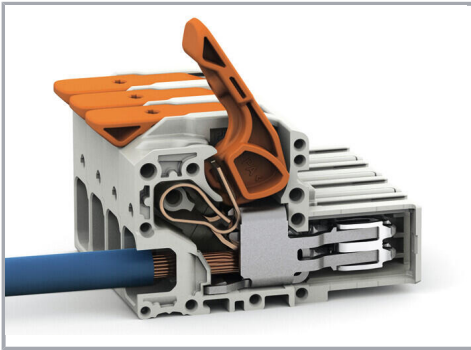

Insert fine-stranded conductors – and remove all conductors – via operating tool.

Conductor termination

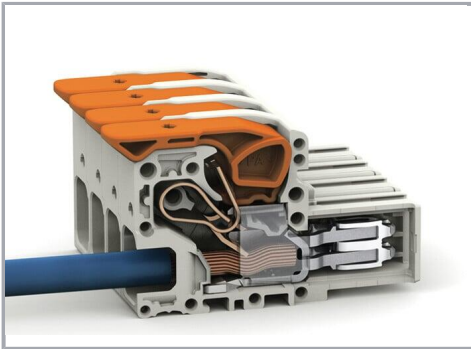

Fine-stranded wires, connected

Product family

MCS MAXI 16

[Show all products from the family](#)

Subject to changes. Please also observe the further product documentation!