

SHAPE OF 2CKTS

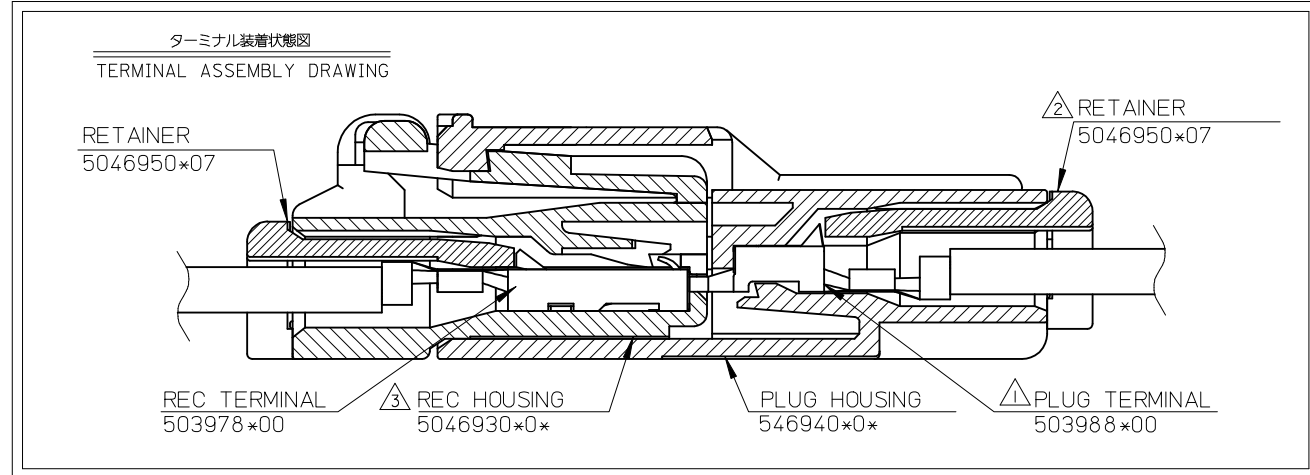
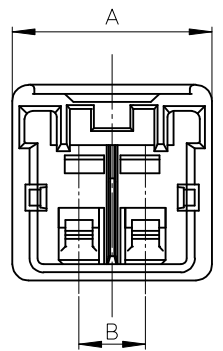
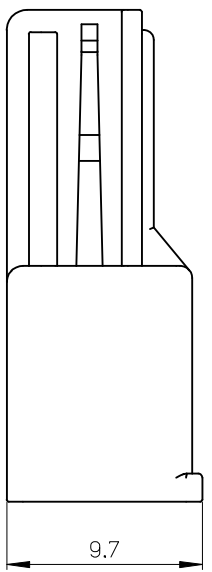
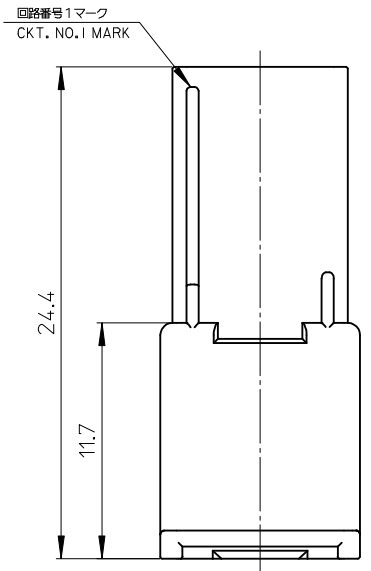
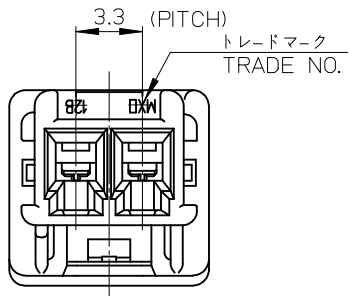

- 注記
NOTES
- △ 適合ターミナル : 50398 シリーズ
APPLICABLE TERMINAL : 50398 SERIES
 - △ 適合リテーナー : 504695 シリーズ
APPLICABLE RETAINER : 504695 SERIES
 - △ 嵌合相手 : 504693 シリーズ
MATE WITH : 504693 SERIES
4. 材質 :PBT (UL94V-0)
MATERIAL :PBT(UL94V-0)

5. MATERIAL NO. は以下の内容を示す。
MATERIAL NO. :
- 504694 **0*
- 極数 ← **0* → 色
CKT COLOR
- | | |
|--------|---------|
| 0: 自然色 | NATURAL |
| 1: 黒 | BLACK |
| 2: 赤 | RED |
| 3: 黄 | YELLOW |
| 4: 青 | BLUE |
| 5: 桃 | PINK |
| 6: 緑 | GREEN |
| 8: 橙 | ORANGE |
| 9: 紫 | VIOLET |

6. コネクタの取扱いについては、AS-504693-001/002を参照。
PLEASE REFER TO AS-504693-001/002.

16.5	23.1	6	504694060*	504694-0*0*
9.9	16.5	4	504694040*	
6.6	13.2	3	504694030*	
3.3	9.9	2	504694020*	
(B)	A	CKT.	MATERIAL NO.	MODEL NO.

REVISED EC NO: J2015-0993 DRWN: ITO CHKD: KASAKAWA APPR: NUKITA	DESCRIPTION 2015/01/29 2015/02/10 2015/02/12	GENERAL TOLERANCES (UNLESS SPECIFIED)		DIMENSION STYLE		SCALE	DESIGN UNITS	THIRD ANGLE PROJECTION	
				MM ONLY		5:1	METRIC		
		0.25 UNDER	UNDER	±0.03	DRAWN BY	DATE	TITLE		
		0.25 OVER	0.5 UNDER	±0.05	MIKEDA01	2013/09/06	3.3 W/W CONN. PLUG HOUSING		
		0.5 OVER	1.0 UNDER	±0.1	CHECKED BY	DATE	molex		
1.0 OVER	10 UNDER	±0.2	KASAKAWA	2013/11/28	DOCUMENT NO.				
10 OVER	30 UNDER	±0.25	APPROVED BY	DATE	SD-504694-001				
30 OVER		±0.3	NUKITA	2013/12/03	SHEET NO.				
ANGULAR ±1 °		MATERIAL NO.		SEE CHART		1 OF 2			
DRAFT WHERE APPLICABLE MUST REMAIN WITHIN DIMENSIONS		SIZE		THIS DRAWING CONTAINS INFORMATION THAT IS PROPRIETARY TO MOLEX INCORPORATED AND SHOULD NOT BE USED WITHOUT WRITTEN PERMISSION					
		A3							

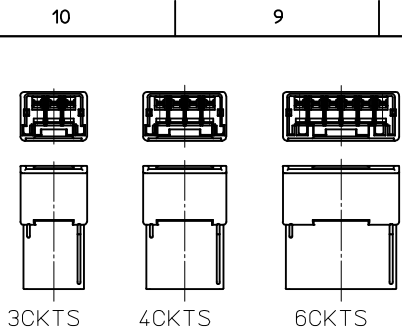

VIEW OF 3,4,6CKTS
(SCALE 1:1)

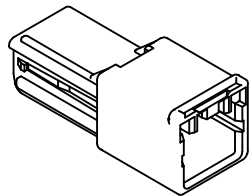

ISOMETRIC VIEW
(SCALE 2:1)

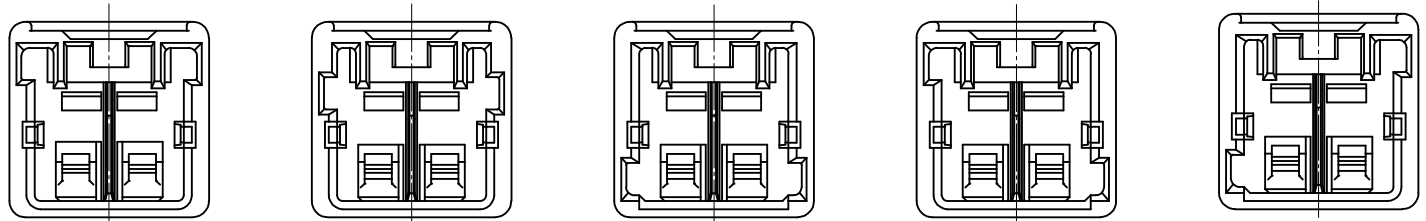

KEY TYPE:1 COLOR:NATURAL
MATERIAL NO.:05046940200

KEY TYPE:2 COLOR:BLACK
MATERIAL NO.:5046940201

KEY TYPE:3 COLOR:RED
MATERIAL NO.:5046940202

KEY TYPE:4 COLOR:YELLOW
MATERIAL NO.:5046940203

KEY TYPE:5 COLOR:BLUE
MATERIAL NO.:5046940204

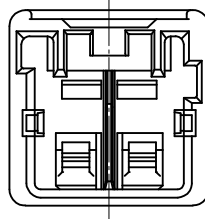

KEY TYPE:6 COLOR:PINK
MATERIAL NO.:5046940205

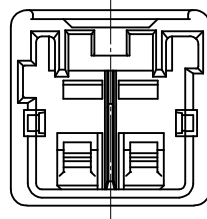

KEY TYPE:7 COLOR:GREEN
MATERIAL NO.:5046940206

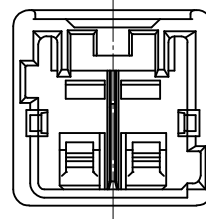

KEY TYPE:8 COLOR:ORANGE
MATERIAL NO.:5046940208

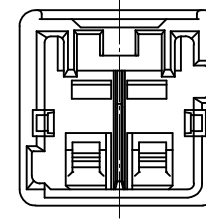

KEY TYPE:9 COLOR:VIOLET
MATERIAL NO.:5046940209

MATING
KEY TYPE & COLOR

REFERENCE 2 CKTS

504693060*	5046950607	6					5046940604	5046940603	5046940602	5046940601	5046940600
504693040*	5046950407	4					5046940404	5046940403	5046940402	5046940401	5046940400
504693030*	5046950307	3								5046940301	5046940300
504693020*	5046950207	2	5046940209	5046940208	5046940206	5046940205	5046940204	5046940203	5046940202	5046940201	5046940200
MATE WITH	COMFORTABLE-RETAINER	CKT.	VIOLET	ORANGE	GREEN	PINK	BLUE	YELLOW	RED	BLACK	NATURAL

MATERIAL NO.

REVISED EC NO: J2015-0993 DRW:NITO 2015/01/29 CHKD:KASAKAWA 2015/02/10 APPR:NUKITA 2015/02/12	GENERAL TOLERANCES (UNLESS SPECIFIED)		DIMENSION STYLE MM ONLY		SCALE 5:1	DESIGN UNITS METRIC	THIRD ANGLE PROJECTION
	0.25 UNDER	UNDER	±0.03	DRAWN BY MIKEDA01	DATE 2013/09/06	TITLE 3.3 W/W CONN. PLUG HOUSING	
	0.25 OVER	0.5 UNDER	±0.05	CHECKED BY KASAKAWA	DATE 2013/11/28		
	0.5 OVER	1.0 UNDER	±0.1	APPROVED BY NUKITA	DATE 2013/12/03		
1.0 OVER	10 UNDER	±0.2	MATERIAL NO.		DOCUMENT NO.	SHEET NO.	
10 OVER	30 UNDER	±0.25	SEE CHART		SD-504694-001	2 OF 2	
30 OVER		±0.3	DRAFT WHERE APPLICABLE MUST REMAIN WITHIN DIMENSIONS				THIS DRAWING CONTAINS INFORMATION THAT IS PROPRIETARY TO MOLEX INCORPORATED AND SHOULD NOT BE USED WITHOUT WRITTEN PERMISSION
ANGULAR	±1 °		SIZE A3				