

SUBCON 25/F-SH

Order No.: 2761619

The illustration shows version SUBCON 9/M-SH

<http://eshop.phoenixcontact.de/phoenix/treeViewClick.do?UID=2761619>

SUB-D connector with one cable entry, 25-pos., female version

Commercial data

EAN	4017918107987
Pack	1 pcs.
Customs tariff	85366990
Weight/Piece	0.0825 KG
Catalog page information	Page 555 (IF-2009)

Product notes

WEEE/RoHS-compliant since:
08/10/2006

<http://www.download.phoenixcontact.com>
Please note that the data given here has been taken from the online catalog. For comprehensive information and data, please refer to the user documentation. The General Terms and Conditions of Use apply to Internet downloads.

Technical data

General data

Nominal voltage U_N	60 V AC/DC
Nominal current I_N	1 A
Insertion/withdrawal cycles	> 200
Max. cable diameter	10 mm
Min. cable diameter	4 mm

SUBCON fixing screws	4-40 UNC
Tightening torque	0.4 Nm
Ambient temperature (operation)	-20 °C ... 75 °C
Housing material	ABS, metal-plated
Pin assignment	All connections are 1:1 on the screw terminal block
Width	16 mm
Height	49.5 mm
Length	78.7 mm

Connection data

Connection	D-SUB connection
Number of positions	25
Type of connection	D-SUB socket
Connection	PCB connection
Type of connection	Screw connection
Conductor cross section solid min.	0.14 mm ²
Conductor cross section solid max.	1.5 mm ²
Conductor cross section stranded min.	0.14 mm ²
Conductor cross section stranded max.	1 mm ²
Conductor cross section AWG/kcmil min.	26
Conductor cross section AWG/kcmil max	16
Stripping length	5 mm
Tightening torque	0.4 Nm

Certificates / Approvals



Certification CUL, GOST, UL

Accessories

Item	Designation	Description
------	-------------	-------------

Assembly

2799694	SUBCON-SHORT-SCREW	Optional fixing screw, short (w/o knurl)
---------	--------------------	--

Diagrams/Drawings

Dimensioned drawing

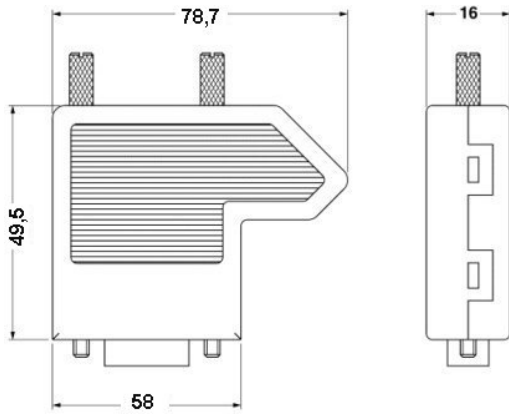

Address

PHOENIX CONTACT Deutschland GmbH
Flachmarktstr. 8
32825 Blomberg, Germany
Phone +49 5235 3 12000
Fax +49 5235 3 41200
<http://www.phoenixcontact.de>



© 2010 Phoenix Contact
Technical modifications reserved;