



MESUR® Lite data acquisition software is included with the WT3-200

The WT3-201 is designed to measure the pull-off force of wire and tube terminations. An ergonomic lever allows for easy application of up to 200 lbF (1,000 N) of force. Adjustable terminal fixture contains multiple slots for diameters up to AWG 3 (0.25 in [6.3 mm]). The tester accommodates most insulation types. Samples can be sent to Mark-10 for evaluation prior to purchase.

A large, backlit graphic LCD displays easy-to-read values, including real-time force, peak force, programmable pass/fail limits, units of measurement, and more. Data can be transferred to a PC or other data collector via USB, RS-232, Mitutoyo (Digimatic), or analog outputs. An analog load bar is shown on the display for graphical representation of applied force.

On-board data storage for up to 1,000 readings is included, as are statistical calculations and output to a PC. Unique automatic output / data storage / zeroing upon sample break helps automate testing processes.

An optional ring terminal fixture may be used to secure ring terminations, and an optional carrying case makes transportation simple and safe.

The WT3-201 includes MESUR® Lite data acquisition software. MESUR® Lite tabulates continuous or single point data. Data stored in the tester's memory can also be downloaded in bulk. One-click export to Excel allows for further data manipulation.

Features

- Measures real-time and peak forces
- Ergonomic lever operation produces 200 lbF (1,000 N)
- Terminal fixture suits wires up to Ø0.25 in [6.3 mm]
- USB, RS-232, Mitutoyo (Digimatic), and analog outputs
- Automatic output / data storage / zeroing upon sample break helps automate testing processes
- 1,000-point data memory with statistics and outputs
- Password protection prevents unauthorized changes
- Programmable set point indicators and outputs for pass / fail determination
- High-speed 7,000 Hz sampling rate accurately captures peak force values
- Configurable audio alarms and key tones
- Mounting holes for bench mounting

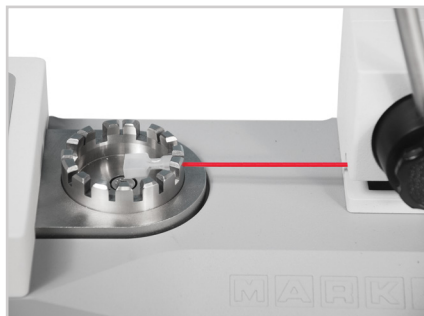

Adjustable wire terminal fixture accommodates wire diameter sizes up to 0.25 in (6.3 mm)



Ergonomic lever easily applies force and releases the sample.

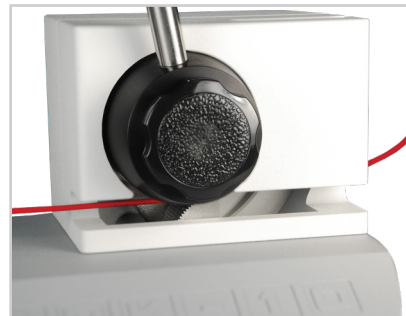

Unique knurled cam design effectively secures and pulls the loose end of the sample.

Controls & Indicators

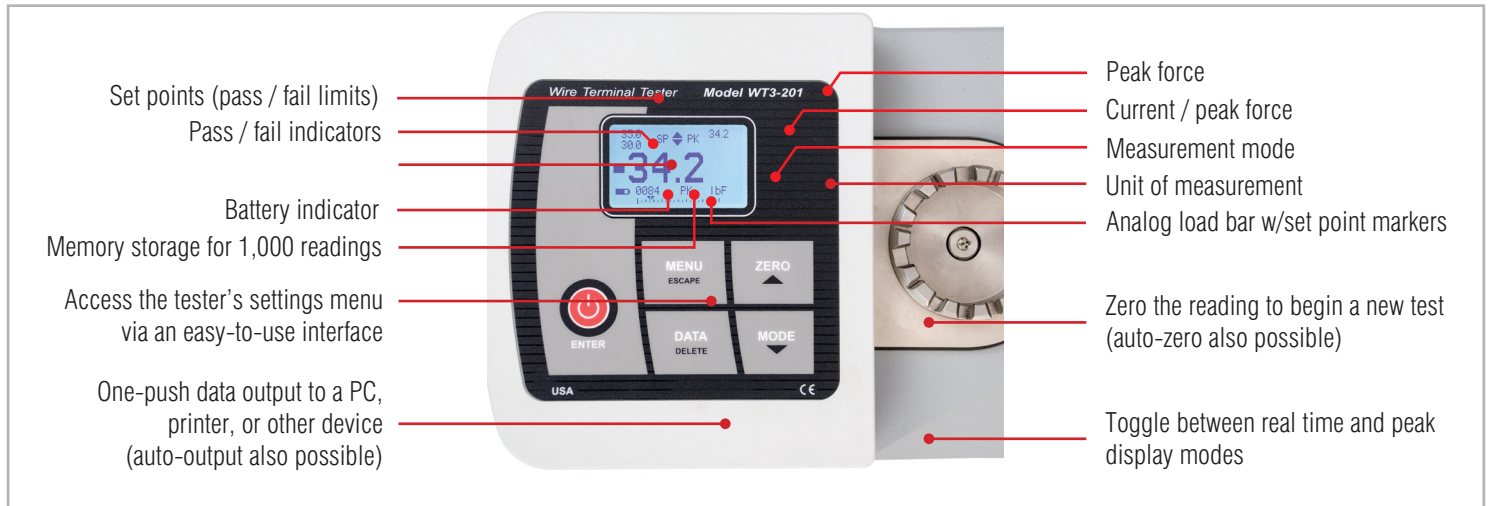

Specifications

Force Capacity:	200 x 0.1 lbf, 3200 x 2 ozF, 100 x 0.05 kgF, 1,000 x 0.5 N, 1 x 0.0005 kN
Accuracy:	±0.2% of full scale
Wire diameter range:	AWG30 - AWG 3 [0.01 - 0.25 in (0.3 - 6.3 mm)]
Minimum sample length:	6.0 in [152 mm], excluding termination
Max. elongation:	1.15 in [29.2 mm]
Power:	AC adapter: 100-240VAC, 50-60 Hz, 0.3 A Battery: Rechargeable 8.4V NiMH Low battery indicator appears when battery level is low, and gauge powers off automatically when power reaches critical stage.
Sampling Rate:	7,000 Hz
Outputs:	USB / RS-232: Configurable up to 115,200 baud. Mitutoyo: Serial BCD suitable for all Mitutoyo SPC-compatible devices. Analog: ±1 VDC, ±0.25% of full scale at capacity.
Safe overload:	150% of full scale (display shows "OVER" at 110% and above)
Weight:	16.1 lb [7.3 kg]
Environmental requirements:	40 - 100°F, max. 96% humidity, non-condensating
Warranty:	3 years (see individual statement for further details)

Dimensions in [mm]

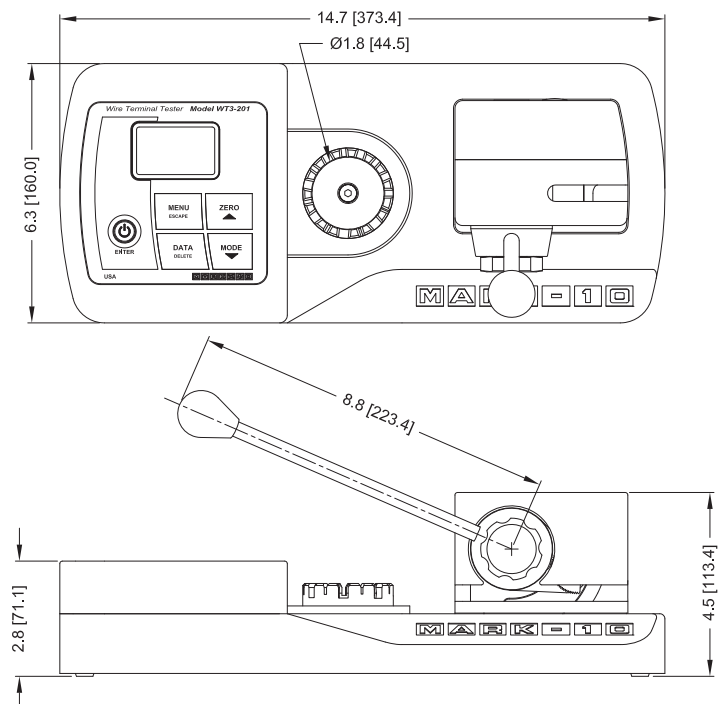

Optional Items

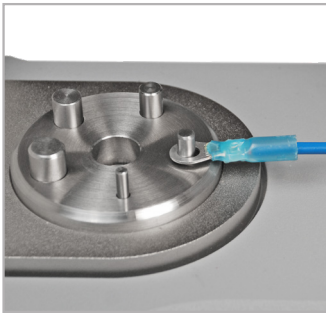

WT3002
Ring terminal fixture
 Secures ring terminations. Pin diameter sizes from 1/8 to 3/8 in [3.2 to 9.5 mm].

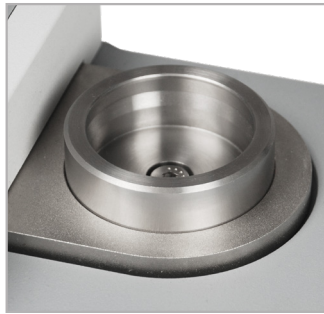

WT3003
Machinable blank terminal fixture
 For unique sample shapes and sizes.



WT3004
Carrying case
 Provides storage space for the WT3-201 tester, optional ring terminal fixture, AC adapter, USB cable, and accessories.

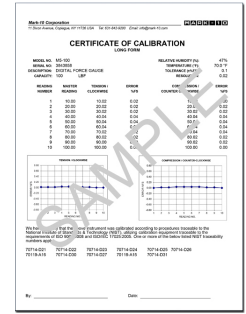

CERT
Calibration certificate w/data
 Includes 10 data points (short form certificate without data is included).



In The Box

The WT3-201 Wire Crimp Pull Tester is shipped as shown at right and includes the following accessories:

- (1) Removable lever
- (1) USB cable
- (1) Battery
- (1) AC adapter
- (1) Certificate of calibration without data (data is optional)

< AC1049
Calibration fixture
 Complete set of brackets and hardware for calibration of a WT3-201, WT3-201M, or WT3-200 tester. Weights not available from Mark-10.

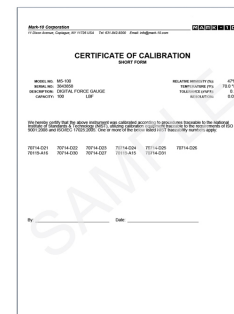

Ordering Information

Model	Description
WT3-201	Wire terminal tester, 110V
WT3002	Ring terminal fixture
WT3003	Machinable blank terminal fixture
WT3004	Carrying case
AC1049	Calibration kit
CERT	Certificate of calibration with data

Includes a 110V AC adapter. Add suffix 'E' for euro plug (220V), 'U' for UK plug (220V) or 'A' for Australian plug (220V). Ex: WT3-201E

