



Micro Modules

(Substrates with Built-in ICs, Products Utilizing with SESUB)

Bluetooth® V4.1 Smart (Low Energy) Single Mode Module

SESUB-PAN-D14580

Caution

The products in this catalog will be or have been stopped production

Discontinue Issue Date	Nov. 2, 2020
Last Purchase Order Date	Apr. 30, 2021
Last Shipment Date	Jun. 30, 2021

Please refer to our Web site about replacement information.

Micro Modules

(Substrates with Built-in ICs, Products Utilizing with SESUB)

Bluetooth® V4.1 Smart (Low Energy) Single Mode Module

Overview of SESUB-PAN-D14580

FEATURES

- Ultra small package - Ideal for for wearable devices
- Space saving Ultra small package 3.5 x 3.5 x 1.0mm (TYP)
- Packaged in 36 pin solder bumped BGA with 0.5mm pitch
- Compatible with Bluetooth® Smart Ready products
- ARM Cortex-M0 32bit high performance microcontroller
- 32kB OTP programmable memory, 84kB ROM for BT stack
- 42kB System SRAM, 8kB Retention SRAM
- Including IC (Dialog Semiconductor : DA14580), Crystal (16MHz), Inductor, and Capacitor in this module.

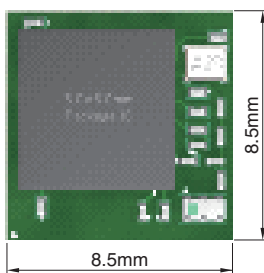

Discrete Solution
72.3mm²

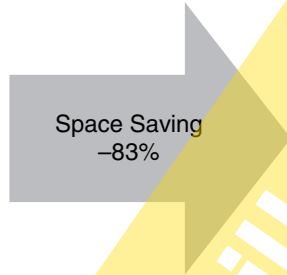

* Production Part is over molded

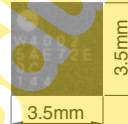

0.5mm pitch
Solder Bumped BGA
36pins

SESUB-PAN-D14580
12.3mm²

APPLICATION

- Healthcare/sports & fitness equipment
(Example: Activity mass meter, thermometer, sphygmomanometer, blood oximeter, blood glucose meter, heart rate meter, biometrics)
- Wearable devices
(Example: Wristband, watch, ring, glasses, shoes, hat, shirt)
- Home entertainment equipment
(Example: Remote control, sensor tag, toys, lighting products)
- PC peripheral applications
(Example: Mouse, key board, stylus, presentation pointer)

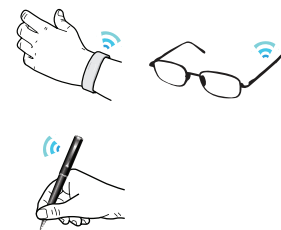

○ Bluetooth® and Bluetooth® Low Energy are the standards established by Bluetooth Special Interest Group (SIG).

SESUB-PAN-D14580

SHAPE & DIMENSIONS

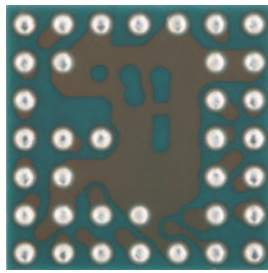
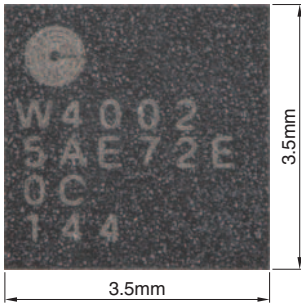

0.5mm pitch
Solder Bumped BGA
36pins

* Production Part is over molded

ELECTRICAL CHARACTERISTICS

CHARACTERISTICS SPECIFICATION TABLE

Communication standard	2.4GHz Bluetooth® V4.1 Low Energy
Transmitter output power level	0dBm (typ)
Receiver sensitivity level	-94dBm
Host Interface	UART (2ch) / SPI+ / I2C (100k/400kHz)
Peripheral Interface	10bits ADC (4ch) / Pin-configurable GPIO
Current consumption	5.0mA (Tx), 5.4mA (Rx), 0.8μA (Deep Sleep mode)

RF CHARACTERISTICS

Frequency vs. TX Power

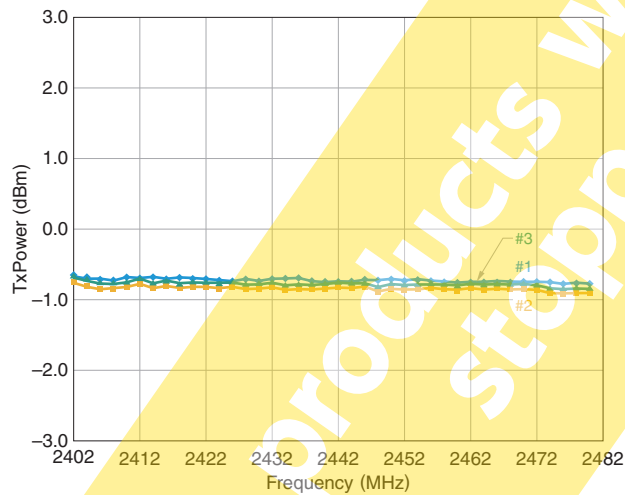

Frequency vs. Sensitivity

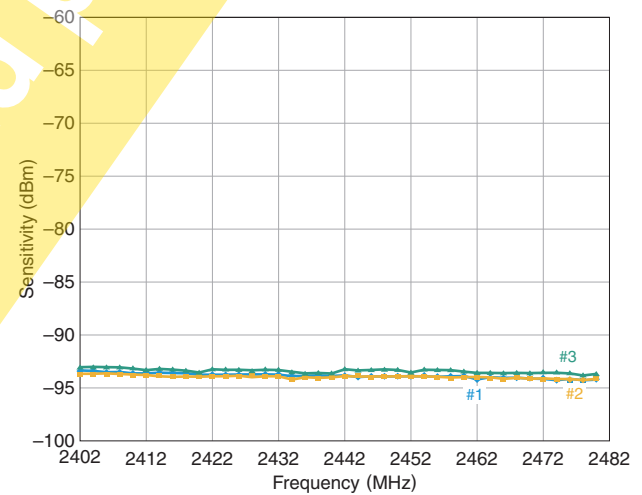

SESUB-PAN-D14580

■ SESUB-PAN-D14580 EVALUATION BOARD [SP14817]

- TDK's SP14817, Daughter board is ready to connect with Dialog Semiconductor's evaluation mother board. This allows for quick designs by utilizing Dialog's -software development tools and development materials

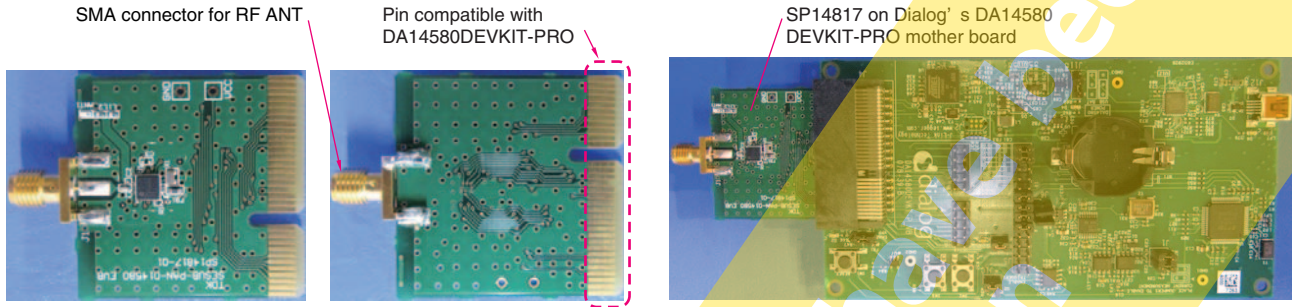

■ SESUB-PAN-D14580 EVALUATION KIT [SESUB-PAN-D14580EVK]

- Regulatory certified evaluation module [SP14808] with integrated 128kB Serial Flash ROM for reprogramming during development. Evaluation Module is ideal for immediate software development.

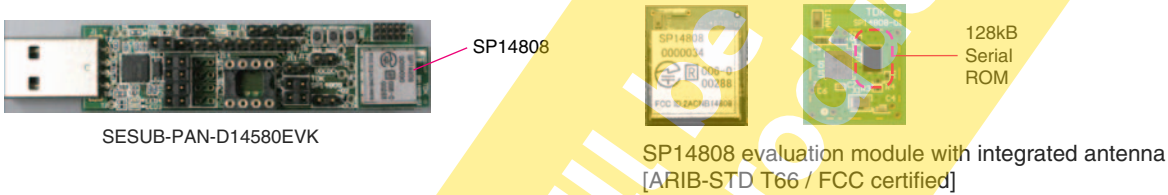

■ ORDERING INFORMATION

Ordering Code	Contents	MOQ	Remark
SESUB-PAN-D14580		1000pcs	
SP14817		1pc	Evaluation board for RF characteristics.
SESUB-PAN-D14580 EVK	SP14808	1pc	SESUB-PAN-D14580 Evaluation Module with ANT
	SP14809	1pc	Certified Japanese & FCC Radio Certification Adapter Board for SP14808.
SP14808		1pc	For the customer who wants to have spare units.
SP14808 ST		1set	SP14808ST contains 5 pcs of SP14808 in a set. Volume discount.