



TIM100-3010200

TiM

2D LIDAR SENSORS

**SICK**  
Sensor Intelligence.



### Ordering information

Type	Part no.
TIM100-3010200	1077524

Other models and accessories → [www.sick.com/TiM](http://www.sick.com/TiM)



### Detailed technical data

#### Features

<b>Measurement principle</b>	HDDM <sup>+</sup>
<b>Application</b>	Indoor
<b>Light source</b>	Infrared (850 nm)
<b>Laser class</b>	1 (IEC 60825-1:2014, EN 60825-1:2014)
<b>Aperture angle</b>	Horizontal 200°
<b>Scanning frequency</b>	14.5 Hz
<b>Angular resolution</b>	1°
<b>Working range</b>	0.05 m ... 3 m
<b>Scanning range</b>	At 10% remission 1.2 m ... 1.5 m, depending on the angle

#### Mechanics/electronics

<b>Connection type</b>	1 x 5-pin M12 male device connector (rotatable)
<b>Supply voltage</b>	9 V DC ... 28 V DC <sup>1)</sup>
<b>Power consumption</b>	Typ. 2.2 W
<b>Output current</b>	≤ 100 mA
<b>Housing color</b>	Light blue (RAL 5012)
<b>Enclosure rating</b>	IP65 (IEC 60529:1989+AMD1:1999+AMD2:2013)
<b>Protection class</b>	III (IEC 61140:2016-1)
<b>Weight</b>	90 g, without connecting cables
<b>Dimensions (L x W x H)</b>	60 mm x 60 mm x 75.8 mm

<sup>1)</sup> When using IO-Link output  $V_s > 18$  V.

## Safety-related parameters

<b>MTBF</b>	50 years
<b>MTTFd</b>	> 100 years

## Performance

<b>Response time</b>	Typ. 70 ms
<b>Detectable object shape</b>	Almost any
<b>Systematic error</b>	$\pm 50 \text{ mm}^1$
<b>Statistical error</b>	$20 \text{ mm}^1$
<b>Integrated application</b>	Field evaluation
<b>Number of field sets</b>	1 field set
<b>Simultaneous evaluation cases</b>	1 (2 fields)

<sup>1)</sup> Typical value; actual value depends on environmental conditions.

## Interfaces

<b>IO-Link</b>	✓
Function	AUX, parameterization
<b>Digital inputs</b>	1
<b>Digital outputs</b>	2 (Push-pull)
<b>Delay time</b>	69 ms ... 30,015 ms (configurable)
<b>Dwell time</b>	69 ms ... 30,015 ms (configurable)
<b>Optical indicators</b>	2 LEDs (ON, switching status)

## Ambient data

<b>Object remission</b>	4 % ... 1,000 % (reflectors)
<b>Electromagnetic compatibility (EMC)</b>	IEC 61000-6-3:2006+AMD1:2010 / IEC 61000-6-2:2005
<b>Vibration resistance</b>	
Sine resonance scan	10 Hz ... 500 Hz <sup>1)</sup>
Sine test	10 Hz ... 500 Hz, 5 g, 10 frequency cycles <sup>1)</sup>
Noise test	10 Hz ... 500 Hz, 5 g RMS, 2 h <sup>2)</sup>
<b>Ambient operating temperature</b>	-10 °C ... +50 °C
<b>Storage temperature</b>	-30 °C ... +70 °C
<b>Permissible relative humidity</b>	≤ 95 %, Non-condensing <sup>3)</sup>
<b>Ambient light immunity</b>	80,000 lx

<sup>1)</sup> IEC 60068-2-6:2007.

<sup>2)</sup> IEC 60068-2-64:2008.

<sup>3)</sup> EN 60068-2-30:2005.

## General notes

<b>Note on use</b>	The sensor does not constitute a safety component as defined by relevant legislation on machine safety.
--------------------	---

## Classifications

<b>eCl@ss 5.0</b>	27270990
<b>eCl@ss 5.1.4</b>	27270990

<b>eCl@ss 6.0</b>	27270913
<b>eCl@ss 6.2</b>	27270913
<b>eCl@ss 7.0</b>	27270913
<b>eCl@ss 8.0</b>	27270913
<b>eCl@ss 8.1</b>	27270913
<b>eCl@ss 9.0</b>	27270913
<b>eCl@ss 10.0</b>	27270913
<b>eCl@ss 11.0</b>	27270913
<b>eCl@ss 12.0</b>	27270913
<b>ETIM 5.0</b>	EC002550
<b>ETIM 6.0</b>	EC002550
<b>ETIM 7.0</b>	EC002550
<b>ETIM 8.0</b>	EC002550
<b>UNSPSC 16.0901</b>	41111615

Dimensional drawing (Dimensions in mm (inch))

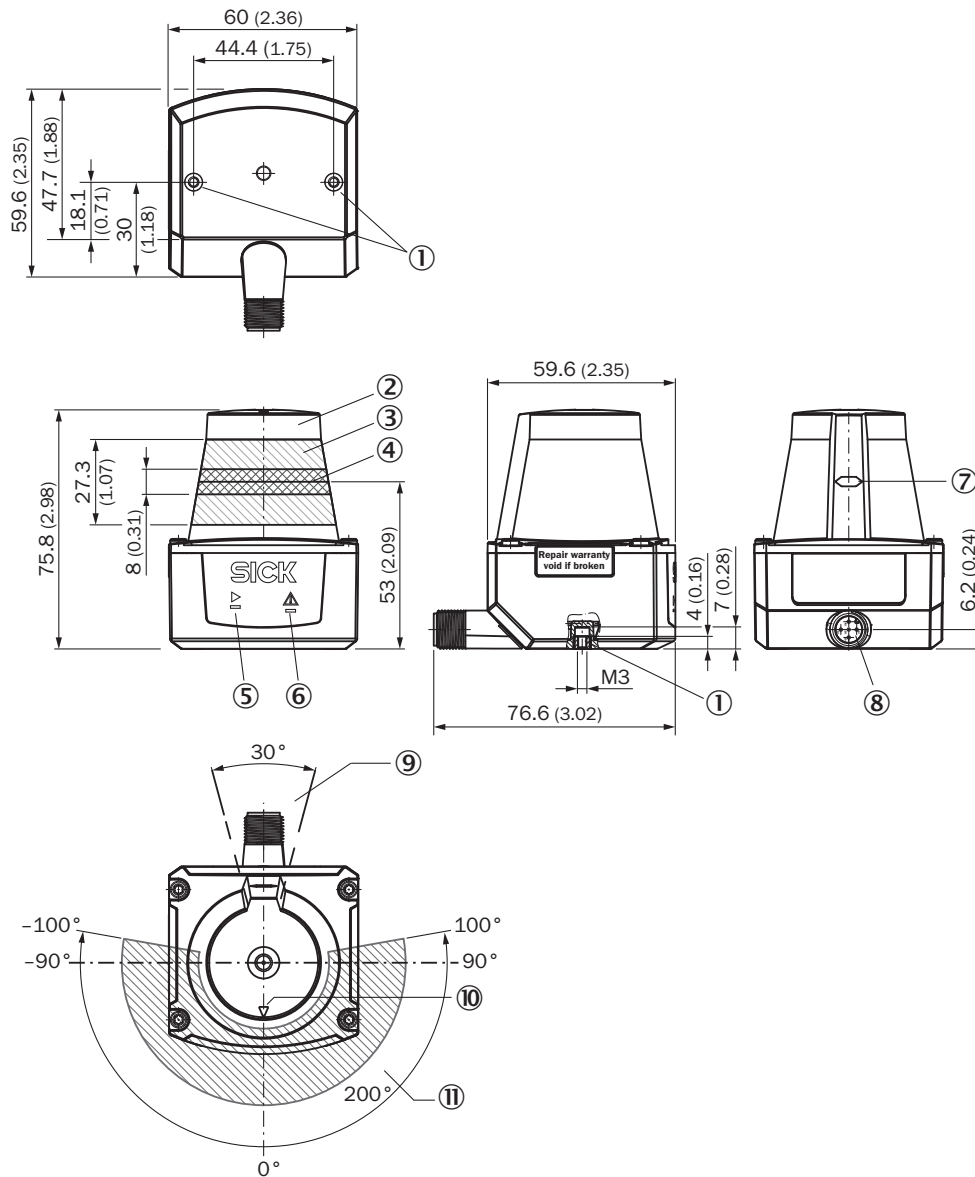

- ① M3 threaded mounting hole, 2.8 mm deep (blind hole thread), max. tightening torque 0.7 Nm
- ② Optical hood
- ③ Receiving range (light inlet)
- ④ Transmission range (light emission)
- ⑤ Green LED
- ⑥ Red LED
- ⑦ Marking for the position of the light emission level
- ⑧ 5-pin M12 male connector (rotatable)
- ⑨ Area in which no reflective surfaces are allowed for mounted devices
- ⑩ Bearing marking to support alignment (0° axis)
- ⑪ Aperture angle 200° (scanning angle)

### Working range diagram



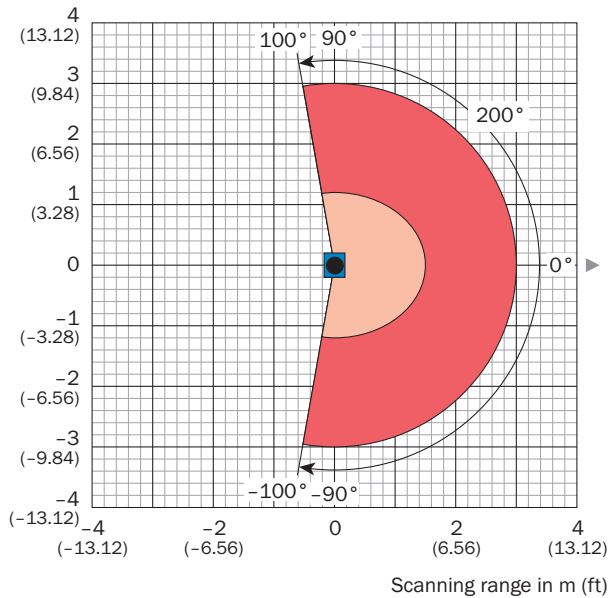

Scanning range in m (ft)



- Scanning range max. 3 m (9.84 ft)
- Scanning range 1.2 m to 1.5 m (3.94 ft to 4.92 ft) for objects with 10 % remission, dependent on the angle

### Recommended accessories

Other models and accessories → [www.sick.com/TiM](http://www.sick.com/TiM)

	Brief description	Type	Part no.
<b>Mounting brackets and plates</b>			
	Mounting kit	Mounting kit	2082188
	Q-lock mounting system	Q-Lock mounting kit	2083311
<b>Plug connectors and cables</b>			
	Head A: female connector, M12, 5-pin, straight, A-coded Head B: Flying leads Cable: Sensor/actuator cable, PUR, halogen-free, unshielded, 2 m	YF2A15-020UB5XLEAX	2095617
	Head A: female connector, M12, 5-pin, straight, A-coded Head B: male connector, M12, 5-pin, straight, A-coded Cable: Sensor/actuator cable, PUR, halogen-free, unshielded, 2 m	YF2A15-020UB5M2A15	2096009
<b>Others</b>			
	IO-Link V1.1 Class A port, USB2.0 port, optional external power supply 24V / 1A		On request

## Recommended services

Additional services → [www.sick.com/TiM](http://www.sick.com/TiM)

	Type	Part no.
Maintenance		
<ul style="list-style-type: none"> <li>• <b>Product area:</b> 2D LiDAR sensors, 3D LiDAR sensors</li> <li>• <b>Range of services:</b> Inspection, analysis and restoring of defined functions, Inspection and adaptation of basic settings, parameters of field application, filters for raw data output, and product-specific configuration</li> <li>• <b>Duration:</b> Additional work will be invoiced separately</li> <li>• <b>Travel expenses:</b> The prices do not include travel costs such as hotel, flight, travel time and expenses.</li> </ul>	Maintenance LMS/MRS/NAV/TiM/LRS/multiScan	1682593
Commissioning		
<ul style="list-style-type: none"> <li>• <b>Product area:</b> 2D LiDAR sensors, 3D LiDAR sensors</li> <li>• <b>Range of services:</b> Inspection of connection, fine adjustment, configuration of monitored areas, configuration and optimization of parameters as well as tests, Setup of previously defined functions of basic settings, parameters of field application, filters for raw data output and product-specific configuration</li> <li>• <b>Travel expenses:</b> The prices do not include travel costs such as hotel, flight, travel time and expenses.</li> <li>• <b>Duration:</b> Additional work will be invoiced separately</li> </ul>	Commissioning LMS/MRS/NAV/TiM/LRS/multiScan (Prime package)	1680672
Extended warranty		
<ul style="list-style-type: none"> <li>• <b>Product area:</b> Identification solutions, machine vision, Distance sensors, Detection and ranging solutions</li> <li>• <b>Range of services:</b> The services correspond to the scope of the statutory manufacturer warranty (SICK general terms of delivery).</li> <li>• <b>Duration:</b> Five-year warranty from delivery date.</li> </ul>	Extended warranty for a total of five years from delivery date	1680671

## SICK AT A GLANCE

SICK is one of the leading manufacturers of intelligent sensors and sensor solutions for industrial applications. A unique range of products and services creates the perfect basis for controlling processes securely and efficiently, protecting individuals from accidents and preventing damage to the environment.

We have extensive experience in a wide range of industries and understand their processes and requirements. With intelligent sensors, we can deliver exactly what our customers need. In application centers in Europe, Asia and North America, system solutions are tested and optimized in accordance with customer specifications. All this makes us a reliable supplier and development partner.

Comprehensive services complete our offering: SICK LifeTime Services provide support throughout the machine life cycle and ensure safety and productivity.

For us, that is “Sensor Intelligence.”

## WORLDWIDE PRESENCE:

Contacts and other locations –[www.sick.com](http://www.sick.com)