

## Product Summary

$V_{(BR)DSS}$	$R_{DS(ON)}$	$I_D$ $T_A = +25^\circ\text{C}$
20V	0.55Ω @ $V_{GS} = 4.5\text{V}$	630mA
	0.9Ω @ $V_{GS} = 1.8\text{V}$	410mA

## Description

This new generation MOSFET has been designed to minimize the on-state resistance ( $R_{DS(ON)}$ ) and yet maintain superior switching performance, making it ideal for high efficiency power management applications.

## Applications

- DC-DC Converters
- Power Management Functions

## Features and Benefits

- Low On-Resistance:  $R_{DS(ON)} = 550_{(max)}\text{m}\Omega$  @  $V_{GS} = 4.5\text{V}$
- Low Gate Threshold Voltage
- Low Input Capacitance
- Fast Switching Speed
- Low Input/Output Leakage
- ESD Protected up to 2KV**
- Totally Lead-Free & Fully RoHS Compliant (Notes 1 & 2)**
- Halogen and Antimony Free. "Green" Device (Note 3)**
- Qualified to AEC-Q101 standards for High Reliability**

## Mechanical Data

- Case: SOT23
- Case Material: Molded Plastic, "Green" Molding Compound. UL Flammability Classification Rating 94V-0
- Moisture Sensitivity: Level 1 per J-STD-020
- Terminals: Finish — Matte Tin annealed over Alloy 42 leadframe. Solderable per MIL-STD-202, Method 208  $\text{e3}$
- Terminal Connections: See Diagram
- Weight: 0.008 grams (approximate)

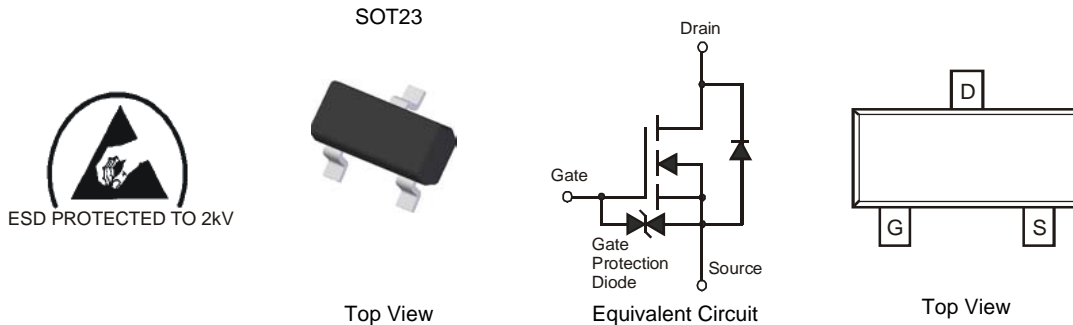

## Ordering Information (Note 4)

Part Number	Case	Packaging
DMN2004K-7	SOT23	3000/Tape & Reel

- Notes:
- No purposely added lead. Fully EU Directive 2002/95/EC (RoHS) & 2011/65/EU (RoHS 2) compliant.
  - See [http://www.diodes.com/quality/lead\\_free.html](http://www.diodes.com/quality/lead_free.html) for more information about Diodes Incorporated's definitions of Halogen- and Antimony-free, "Green" and Lead-free.
  - Halogen- and Antimony-free "Green" products are defined as those which contain <900ppm bromine, <900ppm chlorine (<1500ppm total Br + Cl) and <1000ppm antimony compounds.
  - For packaging details, go to our website at <http://www.diodes.com/products/packages.html>.

## Marking Information

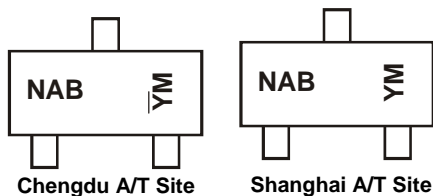

NAB = Product Type Marking Code  
 YM = Date Code Marking for SAT (Shanghai Assembly/ Test site)  
 YM = Date Code Marking for CAT (Chengdu Assembly/ Test site)  
 Y or Y̅ = Year (ex: A = 2013)  
 M = Month (ex: 9 = September)

### Date Code Key

Year	2008	2009	2010	2011	2012	2013	2014	2015				
Code	V	W	X	Y	Z	A	B	C				
Month	Jan	Feb	Mar	Apr	May	Jun	Jul	Aug	Sep	Oct	Nov	Dec
Code	1	2	3	4	5	6	7	8	9	O	N	D

**Maximum Ratings** (@T<sub>A</sub> = +25°C, unless otherwise specified.)

Characteristic			Symbol	Value	Units
Drain-Source Voltage			V <sub>DSS</sub>	20	V
Gate-Source Voltage			V <sub>GSS</sub>	±8	V
Drain Current (Note 5) V <sub>GS</sub> = 4.5V	Steady State	T <sub>A</sub> = +25°C	I <sub>D</sub>	630	mA
		T <sub>A</sub> = +85°C		450	
Drain Current (Note 5) V <sub>GS</sub> = 1.8V	Steady State	T <sub>A</sub> = +25°C	I <sub>D</sub>	410	mA
		T <sub>A</sub> = +85°C		300	
Pulsed Drain Current (Note 6)			I <sub>DM</sub>	1.5	A

**Thermal Characteristics** (@T<sub>A</sub> = +25°C, unless otherwise specified.)

Characteristic	Symbol	Value	Units
Total Power Dissipation (Note 5)	P <sub>D</sub>	350	mW
Thermal Resistance, Junction to Ambient	R <sub>θJA</sub>	357	°C/W
Operating and Storage Temperature Range	T <sub>J</sub> , T <sub>STG</sub>	-65 to +150	°C

**Electrical Characteristics** (@T<sub>A</sub> = +25°C, unless otherwise specified.)

Characteristic	Symbol	Min	Typ	Max	Unit	Test Condition
<b>OFF CHARACTERISTICS (Note 7)</b>						
Drain-Source Breakdown Voltage	BV <sub>DSS</sub>	20	—	—	V	V <sub>GS</sub> = 0V, I <sub>D</sub> = 10μA
Zero Gate Voltage Drain Current	I <sub>DSS</sub>	—	—	1	μA	V <sub>DS</sub> = 16V, V <sub>GS</sub> = 0V
Gate-Source Leakage	I <sub>GSS</sub>	—	—	±1	μA	V <sub>GS</sub> = ±4.5V, V <sub>DS</sub> = 0V
<b>ON CHARACTERISTICS (Note 7)</b>						
Gate Threshold Voltage	V <sub>GS(th)</sub>	0.5	—	1.0	V	V <sub>DS</sub> = V <sub>GS</sub> , I <sub>D</sub> = 250μA
Static Drain-Source On-Resistance	R <sub>DS(on)</sub>	—	0.4	0.55	Ω	V <sub>GS</sub> = 4.5V, I <sub>D</sub> = 540mA
			0.5	0.70		V <sub>GS</sub> = 2.5V, I <sub>D</sub> = 500mA
			0.7	0.9		V <sub>GS</sub> = 1.8V, I <sub>D</sub> = 350mA
Forward Transfer Admittance	Y <sub>fs</sub>	200	—	—	ms	V <sub>DS</sub> = 10V, I <sub>D</sub> = 0.2A
Source Current	I <sub>S</sub>	—	—	0.5	A	—
Diode Forward Voltage (Note 7)	V <sub>SD</sub>	0.6	—	1	V	V <sub>GS</sub> = 0V, I <sub>S</sub> = 500mA
<b>DYNAMIC CHARACTERISTICS</b>						
Input Capacitance	C <sub>iss</sub>	—	—	150	pF	V <sub>DS</sub> = 16V, V <sub>GS</sub> = 0V f = 1.0MHz
Output Capacitance	C <sub>oss</sub>	—	—	25	pF	
Reverse Transfer Capacitance	C <sub>rss</sub>	—	—	20	pF	
Gate Resistance	R <sub>g</sub>	—	292	—	Ω	V <sub>DS</sub> = 0V, V <sub>GS</sub> = 0V, f = 1.0MHz
Total Gate Charge	Q <sub>g</sub>	—	0.9	—	nC	V <sub>DS</sub> = 15V, V <sub>GS</sub> = 4.5V, I <sub>D</sub> = 0.5A
Gate-Source Charge	Q <sub>gs</sub>	—	0.2	—		
Gate-Drain Charge	Q <sub>gd</sub>	—	0.2	—		
Turn-On Delay Time	t <sub>D(on)</sub>	—	5.7	—	ns	V <sub>GS</sub> = 8V, V <sub>DS</sub> = 15V, R <sub>G</sub> = 6Ω, R <sub>L</sub> = 30Ω
Turn-On Rise Time	t <sub>r</sub>	—	8.4	—		
Turn-Off Delay Time	t <sub>D(off)</sub>	—	59.4	—		
Turn-Off Fall Time	t <sub>f</sub>	—	37.6	—		
Body Diode Reverse Recovery Time	t <sub>rr</sub>	—	5.5	—	ns	I <sub>S</sub> = 0.5A, dI/dt = -100A/μs
Body Diode Reverse Recovery Charge	Q <sub>rr</sub>	—	0.85	—	nC	I <sub>S</sub> = 0.5A, dI/dt = -100A/μs

- Notes:
- Device mounted on FR-4 PCB, with minimum recommended pad layout, single sided.
  - Pulse width ≤10μS, Duty Cycle ≤1%.
  - Short duration pulse test used to minimize self-heating effect.

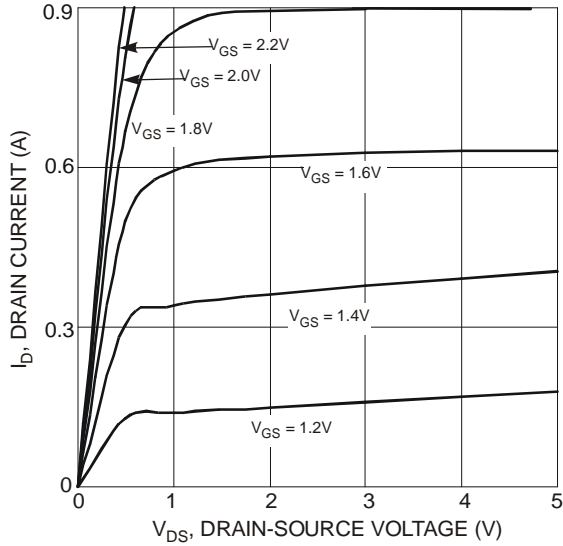

Figure 1 Typical Output Characteristics

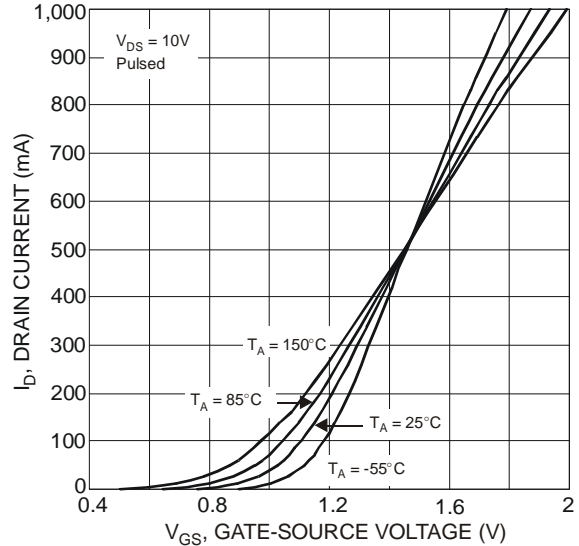

Figure 2 Reverse Drain Current vs. Source-Drain Voltage

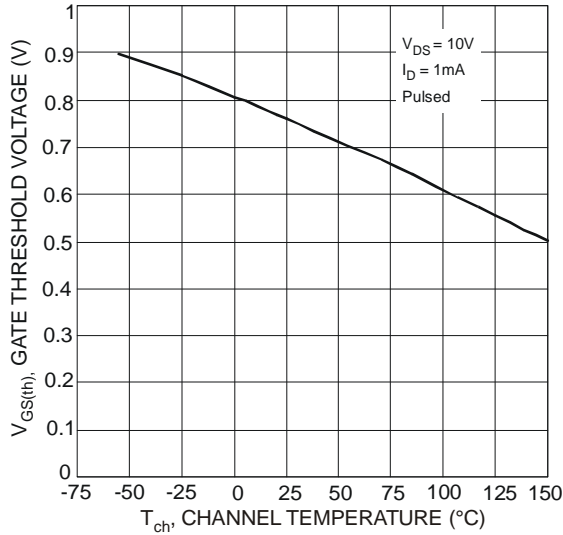

Figure 3 Gate Threshold Voltage vs. Channel Temperature

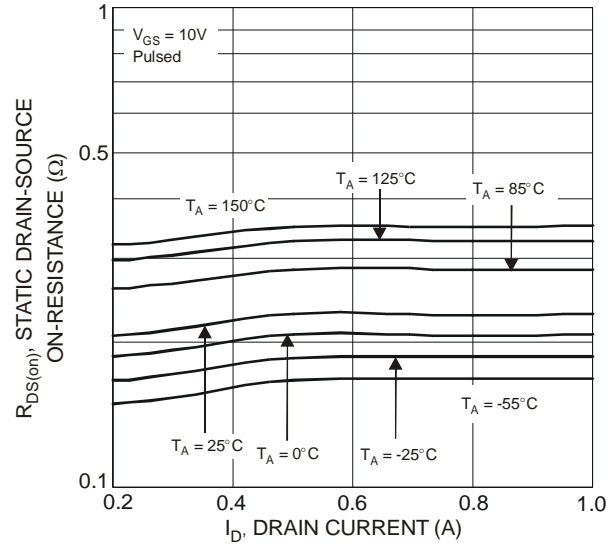

Figure 4 Static Drain-Source On-Resistance vs. Drain Current

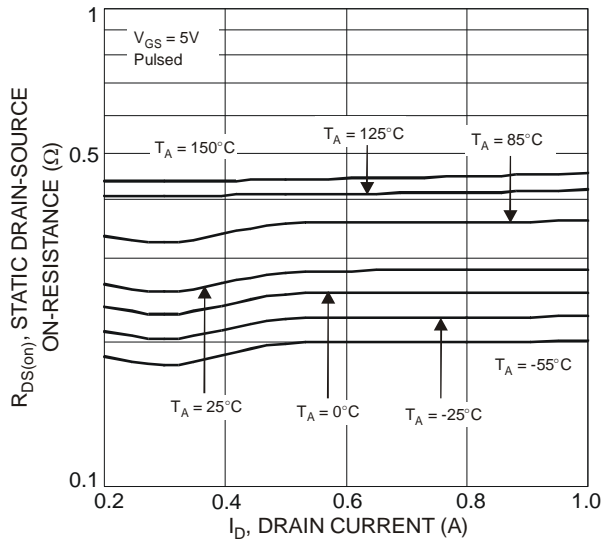

Figure 5 Static Drain-Source On-Resistance vs. Drain Current

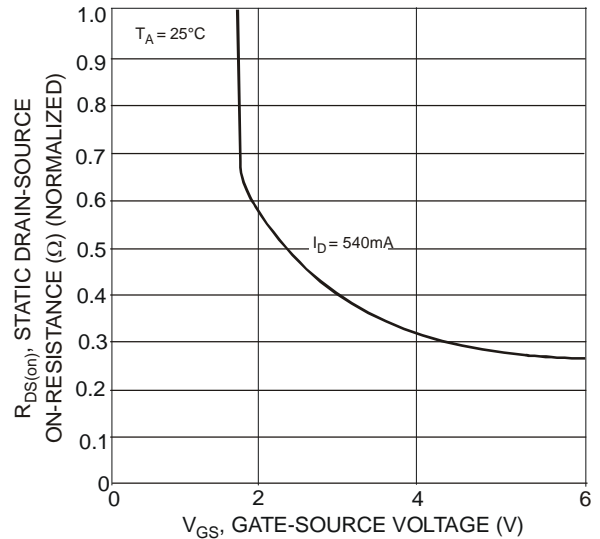

Figure 6 Static Drain-Source, On-Resistance vs. Gate-Source Voltage

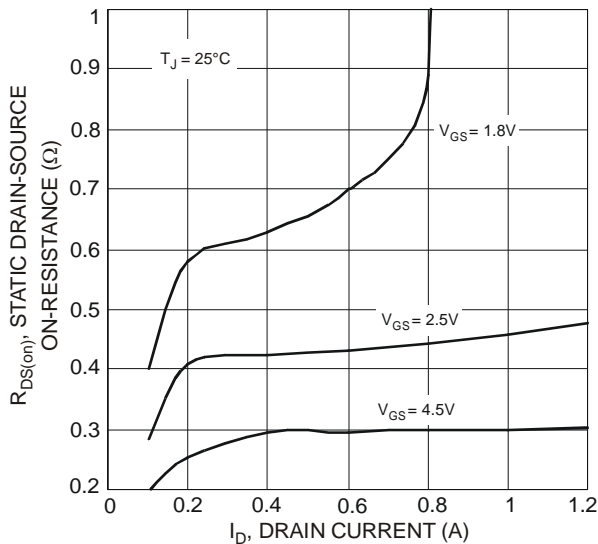

Figure 7 On-Resistance vs. Drain Current and Gate Voltage

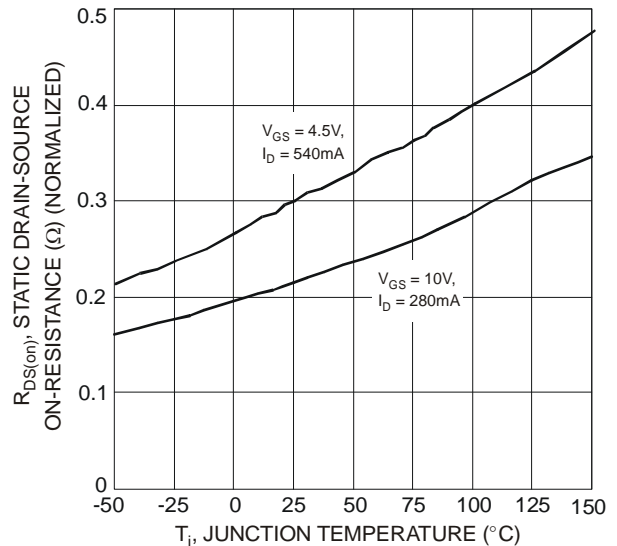

Figure 8 Static Drain-Source, On-Resistance vs. Temperature

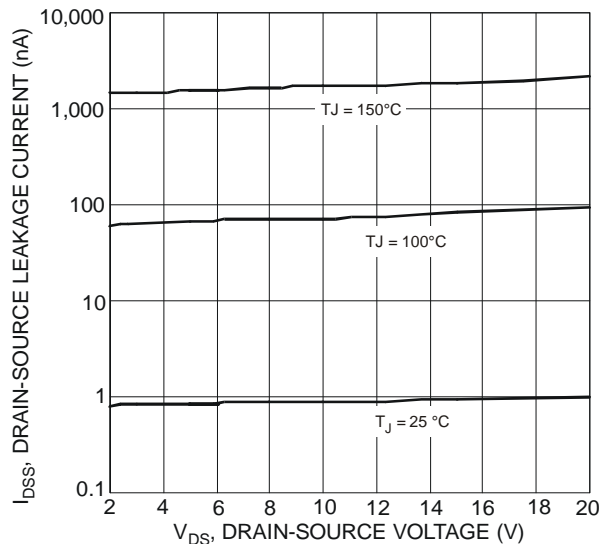

Figure 9 Drain Source Leakage Current vs. Voltage

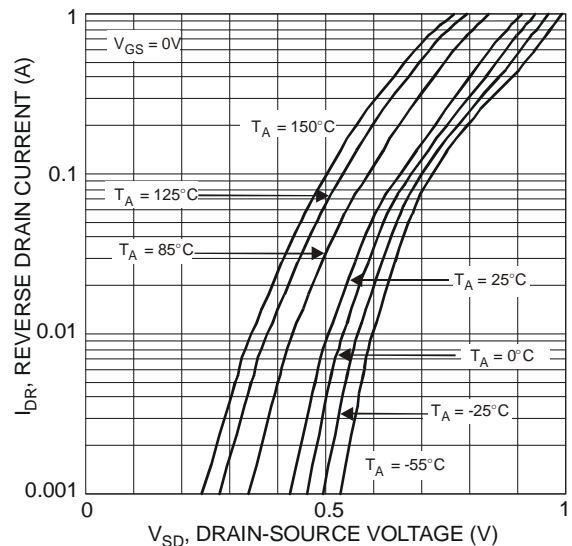

Figure 10 Reverse Drain Current vs. Source-Drain Voltage

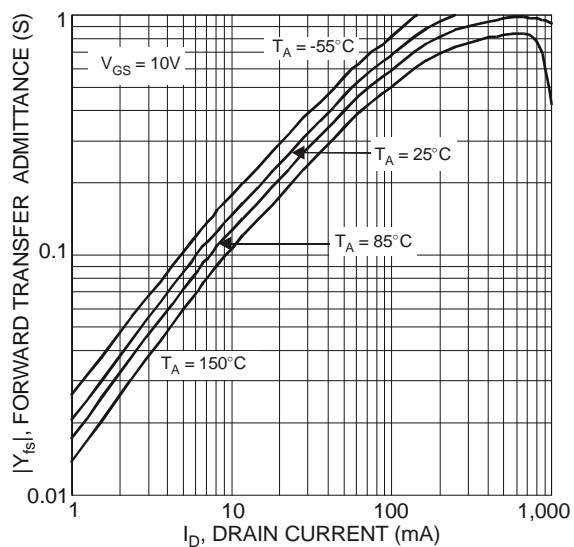

Figure 11 Forward Transfer Admittance vs. Drain Current

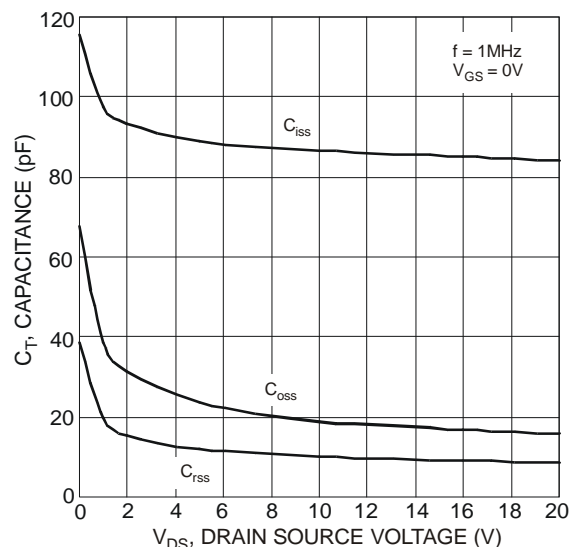

Figure 12 Capacitance Variation

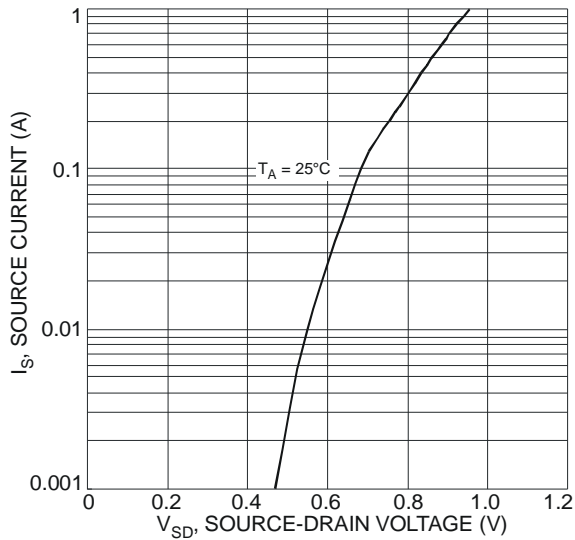

Figure 13 Diode Forward Voltage vs. Current

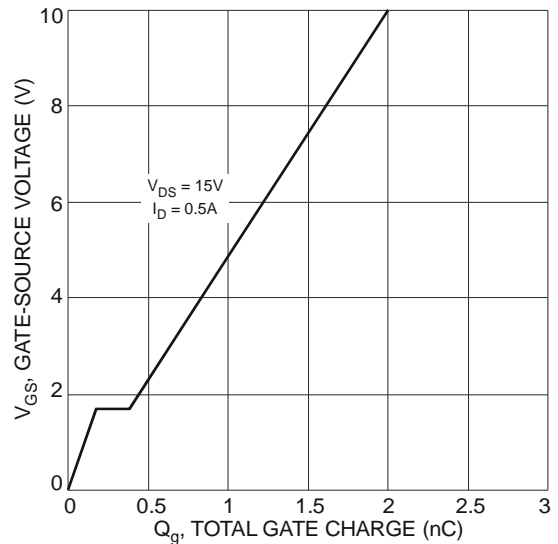
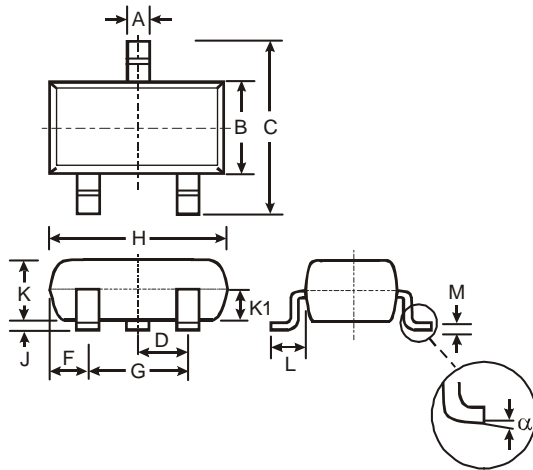

Figure 14 Gate-Charge Characteristics

## Package Outline Dimensions

Please see AP02002 at <http://www.diodes.com/datasheets/ap02002.pdf> for latest version.



SOT23			
Dim	Min	Max	Typ
A	0.37	0.51	0.40
B	1.20	1.40	1.30
C	2.30	2.50	2.40
D	0.89	1.03	0.915
F	0.45	0.60	0.535
G	1.78	2.05	1.83
H	2.80	3.00	2.90
J	0.013	0.10	0.05
K	0.903	1.10	1.00
K1	-	-	0.400
L	0.45	0.61	0.55
M	0.085	0.18	0.11
$\alpha$	0°	8°	-

All Dimensions in mm

## Suggested Pad Layout

Please see AP02001 at <http://www.diodes.com/datasheets/ap02001.pdf> for latest version.

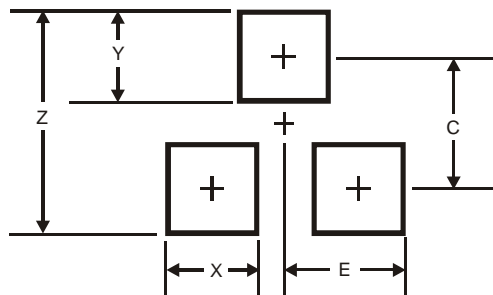

Dimensions	Value (in mm)
Z	2.9
X	0.8
Y	0.9
C	2.0
E	1.35

**IMPORTANT NOTICE**

DIODES INCORPORATED MAKES NO WARRANTY OF ANY KIND, EXPRESS OR IMPLIED, WITH REGARDS TO THIS DOCUMENT, INCLUDING, BUT NOT LIMITED TO, THE IMPLIED WARRANTIES OF MERCHANTABILITY AND FITNESS FOR A PARTICULAR PURPOSE (AND THEIR EQUIVALENTS UNDER THE LAWS OF ANY JURISDICTION).

Diodes Incorporated and its subsidiaries reserve the right to make modifications, enhancements, improvements, corrections or other changes without further notice to this document and any product described herein. Diodes Incorporated does not assume any liability arising out of the application or use of this document or any product described herein; neither does Diodes Incorporated convey any license under its patent or trademark rights, nor the rights of others. Any Customer or user of this document or products described herein in such applications shall assume all risks of such use and will agree to hold Diodes Incorporated and all the companies whose products are represented on Diodes Incorporated website, harmless against all damages.

Diodes Incorporated does not warrant or accept any liability whatsoever in respect of any products purchased through unauthorized sales channel. Should Customers purchase or use Diodes Incorporated products for any unintended or unauthorized application, Customers shall indemnify and hold Diodes Incorporated and its representatives harmless against all claims, damages, expenses, and attorney fees arising out of, directly or indirectly, any claim of personal injury or death associated with such unintended or unauthorized application.

Products described herein may be covered by one or more United States, international or foreign patents pending. Product names and markings noted herein may also be covered by one or more United States, international or foreign trademarks.

This document is written in English but may be translated into multiple languages for reference. Only the English version of this document is the final and determinative format released by Diodes Incorporated.

**LIFE SUPPORT**

Diodes Incorporated products are specifically not authorized for use as critical components in life support devices or systems without the express written approval of the Chief Executive Officer of Diodes Incorporated. As used herein:

A. Life support devices or systems are devices or systems which:

1. are intended to implant into the body, or
2. support or sustain life and whose failure to perform when properly used in accordance with instructions for use provided in the labeling can be reasonably expected to result in significant injury to the user.

B. A critical component is any component in a life support device or system whose failure to perform can be reasonably expected to cause the failure of the life support device or to affect its safety or effectiveness.

Customers represent that they have all necessary expertise in the safety and regulatory ramifications of their life support devices or systems, and acknowledge and agree that they are solely responsible for all legal, regulatory and safety-related requirements concerning their products and any use of Diodes Incorporated products in such safety-critical, life support devices or systems, notwithstanding any devices- or systems-related information or support that may be provided by Diodes Incorporated. Further, Customers must fully indemnify Diodes Incorporated and its representatives against any damages arising out of the use of Diodes Incorporated products in such safety-critical, life support devices or systems.

Copyright © 2013, Diodes Incorporated

[www.diodes.com](http://www.diodes.com)